

LEO Series GigE SWIR Camera User Manual

V2.5.8, Aug. 2025

Preface

Purpose

This Manual is a basic description of LEO series GigE SWIR Cameras, which mainly includes the product description, quick installation guide and Simple introduction of SDK(iDatum). This manual may be updated due to product upgrades or other reasons. If you need, please contact the sales engineer for the latest version of this manual.

Copyright ©2024
Hangzhou Contrastech Co., Ltd.
Tel.: +86 571-89712238
Add.:No. 8 Xiyuan 9th Road, West Lake District Hangzhou Zhejiang 310030 China.

All rights reserved. The information contained herein is proprietary and is provided solely for the purpose of allowing customers to operate and/or service Contrastech manufactured equipment and is not to be released, reproduced, or used for any other purpose without written permission of Contrastech.

Disclaimer

The information and specifications described in this manual are subject to change without notice.

Latest Manual Version

For the latest version of this manual, see the Download Center on our web site at: <http://www.contrastech.com/en/service/005001.html>

Technical Support

For technical support, e-mail: support@contrastech.com.

Warranty

To ensure that your warranty remains in force, adhere to the following guidelines:

Do not remove the camera's serial number label

If the label is removed and the serial number can't be read from the camera's registers, the warranty is void.

Do not open the camera housing

Do not open the housing. Touching internal components may damage them.

Prevent ingress or insertion of foreign substances into the camera housing

Prevent liquid, flammable, or metallic substances from entering the camera housing. If operated with any foreign substances inside, the camera may fail or cause a fire.

Avoid electromagnetic fields

Do not operate the camera in the vicinity of strong electromagnetic fields. Avoid electrostatic charging.

Clean with care

Avoid cleaning the sensor if possible.

Handle this camera with care

Do not abuse the camera. Avoid striking, shaking, etc. The camera could be damaged by improper handling.

Read the manual

Read the manual carefully before using the camera.

CHAPTER 1

PRODUCT DESCRIPTION

Product Introduction

LEO series industrial cameras compatible with GigE、10GigE、USB3.0、Cameralink and CoaXPress data bus standards, support GenICam、USB3 Vision® and GigE Vision®, Smoothly connect with third-party software, like HALCON and Vision Pro, not need for secondary development. LEO series cameras with excellent cost performance and very suitable for various inspections measurement and high-speed imaging applications. This series cameras won customers high praise because its outstanding performance in cellphone and tablet PC screen inspection, LED automatic packaging, defect inspection, and electronic components manufacturing, wafer positioning and other applications.

With this variety of sensors and interfaces, combined with the extensive features offered, LEO series cameras are fit for a wide range of vision applications.

LEO SWIR camera with high-sensitivity InGaAs sensor covering multiple bands from visible to SWIR, high quantum efficiency response, equipped with TEC cooling and better image consistency.

Product Features

- Ethernet interface provides 1Gbps bandwidth, with maximum 100m transmission;
- 128MB on-board frame buffer for data transmission and image retransmission;
- Supports software trigger, hardware trigger, free run mode and etc;
- Supports sharpness, noise reduction, gamma correction, LUT, black level correction, brightness,contrast and other ISP function;
- Supports various output formats for image data and supports ROI, binning, mirror and etc.;
- Conforms GigE Vision protocol and GenICam standards;

* The camera functions may differ by camera models,please refer to actual functions.

Status LED Description

Status LED	Description
Slow Flashing Red (the interval between on and off is 2000 milliseconds)	The camera wiring exception occurs.
Red light is always on	The camera exception occurs.
Blue light is always off	The camera is in idle status.
Fast Flashing Blue (the interval between on and off is 200 milliseconds)	The camera is acquiring images normally.
Slow Flashing blue (the interval between on and off is 1000 milliseconds)	The camera is acquiring images in trigger mode.
Flashing Alternately Red and Blue	The function of finding me is executed, or the firmware is updating.

Mechanical Dimensions

The dimensions is in millimeters:

The cameras are interfaced to an external circuitry via connectors located on the back of the housing.
The Industrial camera rear appearance contains standard RJ45 GigE interface, 6Pin or 12pin power, I/O input connector and camera working status indicator light.

There are two M2 screw holes on both side of GigE interface, which used to fix cable to reduce the loosening caused by vibration.

Camera Housing and Base Mounting Hole Size(mm):

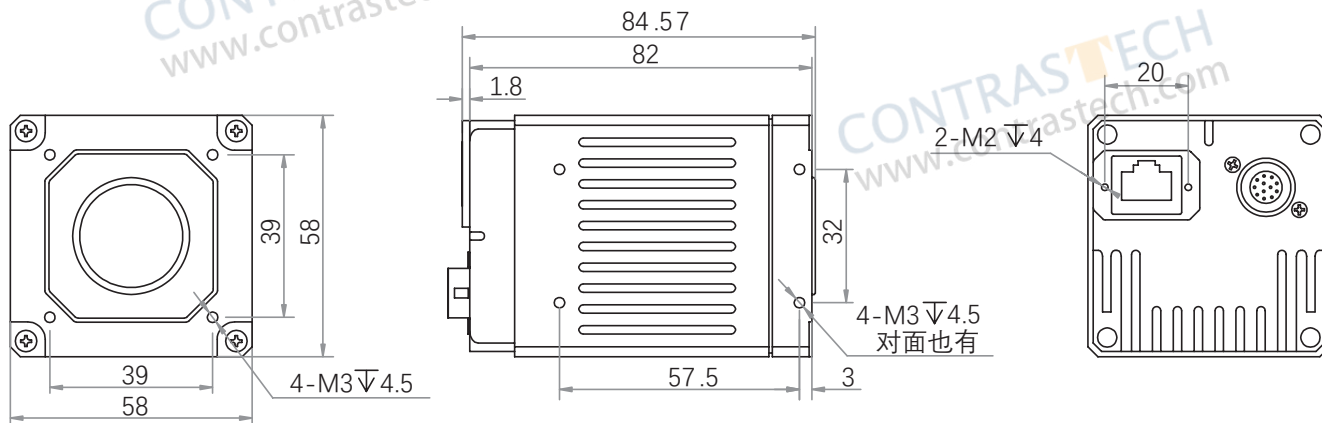

Fig. 1-1: Mechanical Dimensions (in mm) of the C-mount GigE SWIR Cooling Cameras with 58 * 58 * 82mm housing (The installation uses M2 and M3 screws).

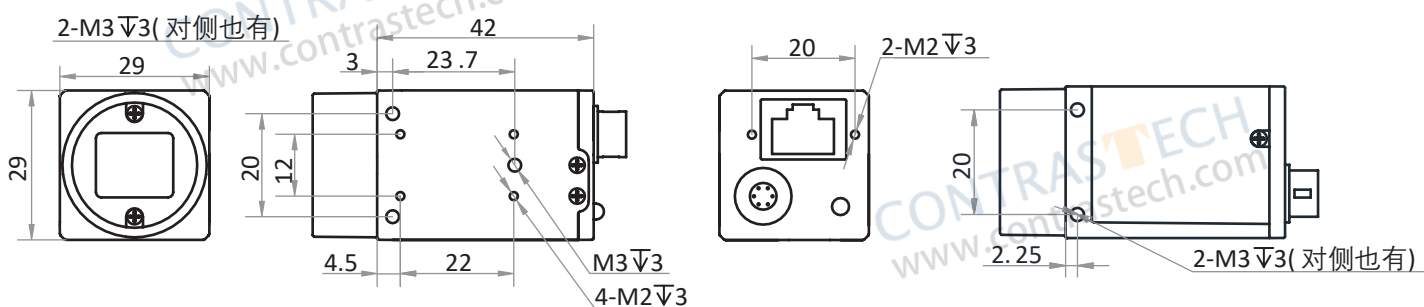

Fig. 1-2: Mechanical Dimensions (in mm) of the C-mount GigE SWIR without Cooling Cameras with 29 * 29 42mm housing (The installation uses M2 and M3 screws).

CHAPTER 2

POWER AND I/O INTERFACE DEFINITION

I/O Connection Definition and Assignments

There is 12-pin power and I/O interfaces. Read the followings to get pin definitions. Refer to the pin definitions and labels attached to the power and I/O cable to wire the device.

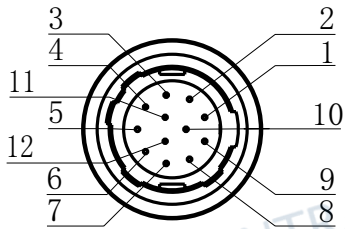

Table 2-1:
Numbering and assignments for 12pin
Power and I/O Input Connector:
(C-Mount with TEC GigE SWIR camera)

Color	Pin	Signal	Signal Source	Designation
Black	1	GND	Line 2-	Camera Power Supply Ground
Red	2	DC_PWR	-	DC Camera Power
Brown	3	DC_PWR	-	DC Camera Power
Orange	4	OPTO_IN	Line 0-	Opto-isolated IN Signal Ground
Yellow	5	OPTO_OUT	Line 1-	Opto-isolated OUT Signal Ground
Green	6	GND	-	DC Camera Power
Blue	7	GND	-	DC Camera Power
Purple	8	RS232_RX	-	RS232 Received Data
Gray	9	RS232_TX	-	RS232 Transmitted Data
White	10	GPIO	Line 2+	Can be Configured as Input or Output
Pink	11	OPTO_OUT	Line 1+	Opto-isolated OUT
Light green	12	OPTO_IN	Line 0+	Opto-isolated IN

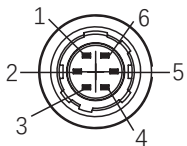

Table 2-2:
Numbering and assignments for 6Pin
Power and I/O Input Connector:
(C-Mount without TEC GigE SWIR camera)

Color	Pin	Signal	Signal Source	Designation
Red	1	DC_PWR	-	DC Camera Power
Green	2	OPTO_IN	Line 0+	Opto-isolated IN
White	3	GPIO	Line 2+	Can be configured as input or output
Blue	4	OPTO_OUT	Line 1+	Opto-isolated OUT
Brown	5	OPTO_GND	Line 0/1-	Opto-isolated Signal Ground
Black	6	GND	Line 2-	Camera Power Supply Ground

The I/O definitions in this manual apply only to ContrasTech standard cables for LEO cameras. Connect according to the I/O types and pinout. Using cables with different color codes from other manufacturers may cause incorrect connections and damage the camera. Always use ContrasTech standard cables.

CHAPTER 3 INSTALLATION AND SETUP

You should perform the software installation procedure first and the hardware installation procedure second.

Software Installation

■ iDatum Installation

If you use a firewall on your computer, disable the firewall for the network adapter to which your camera is connected.

Close the Firewall

In order to ensure the camera software keep running and image transmission stability, please close the firewall before using the software.

System Requirements

LEO Camera Software Suite for Windows requirements that one of the following operating systems is installed on your computer:

- Windows XP (32 bit)
- Windows 7 (32 bit or 64 bit)
- Windows 10 (32 bit or 64 bit)
- Linux 32 Bit/64 Bit : Ubuntu 14.04(32/64)、Ubuntu 16.04(32/64)、Redhat7(64)、Centos7(32/64)、gcc/g++ version requires 4.6.3 and above
- ARM: NVIDIA TX2、RaspberryPiB3.0+

Installation Steps

- 1.You can download the iDatum software(LEO Series Industrial Cameras SDK For xxx)from:
<http://www.contrastech.com/en/service/005001.html>
- 2.Double click iDatum installation package to install the client.
- 3.Follow the instructions on the screen. The installer will guide you through the installation process.

Environment Testing

After successful installation, please connect the camera and turn on iDatum client software to check the result of camera connection and image preview. You can start secondary development base on the SDK when all environment testing is normal.

You should notice follow items when using GigE Camera:

- FrameRate Whether the frame rate is consistent with the actual set frame rate.
- Errors If not 0, it means there is a frame skip, it is abnormal.
- Lost Packets If not 0, it is abnormal.

Hardware Installation

■ Camera Installation

The installation procedures assume that you will be making a peer-to-peer connection between your camera and a computer.

Make sure that the following items are available before starting the installation:

- LEO GigE SWIR camera
- Applicable power supply or a Gigabit Ethernet Switch
- It refers to the lens that matches with lens mount of the camera.
- The computer with a GigE network adapter installed
- The computer must be equipped with appropriate operating system
- Standard Ethernet cable (Cat5e or Cat6a or above).

Steps:

- Mount lens that matches with lens mount of the camera
- Connect the camera to the computer and power
- Connect one end of the Ethernet cable to the computer's network adapter, and the other end to the camera's GigE interface.

For use with TEC (using 12-pin):

- Use the 12-pin power and I/O cable to connect the camera to a power adapter.
- Turn on the power

For use without TEC (using 6-pin) :

- Use the 6-pin power and I/O cable to connect the camera to a power adapter.
- Turn on the power

For use PoE power supply:

- Connect one end of the network cable to the PoE-enabled switch or the network port marked "Data Input" on the network card, and connect the other end of the network cable to the camera interface.

Network Settings

Before using the camera, you need to configure IP is in the same network segment with the computer. You can modify it in "Local Connection" to ensure network communication is normal.

Local Network Configuration :

- Click "Control Panel"> "Network and Internet"> "Network and Sharing Center"> "Change Adapter Configuration." Then select corresponding network card to configure it automatically obtain IP address or manually assign it as same network segment address with the camera. Shown as below:
- Open "Advanced" in the properties, set "Jumbo Frame" as its maximum value:9014bytes, both of transmit buffer and receive buffer set as 2048bytes, the Interrupt Throttle Rate set as extremum value. These maximum values mentioned above depend on the specific network card. Shown as below:

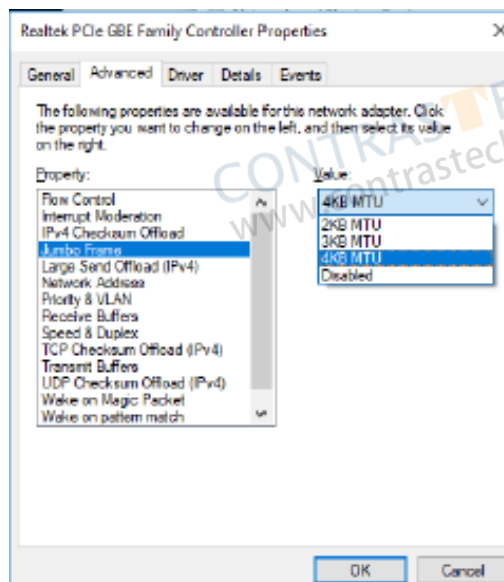

Software Operation

■ iDatum Operation

1、 Double-click the iDatum shortcut on the desktop to open up the client software.

■ Main interface

For specific main window of the client software, please refer to the actual one you got.

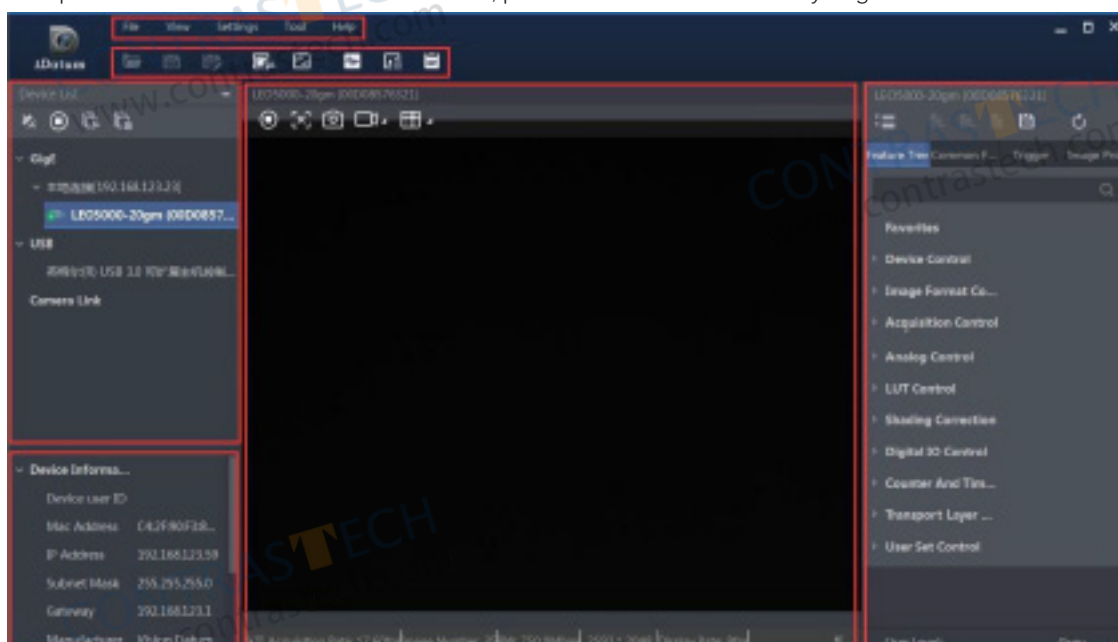

■ Menu Bar

The menu bar for iDatum client provides following functions: File, View, Settings, Tool and Help, as shown in the figure below.

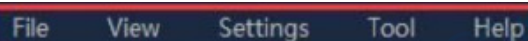

■ Control Toolbar

The control toolbar provides quick operations for the device. the icon meaning is shown in the figure below. The operation buttons in the tool bar can quickly and conveniently edit camera images.

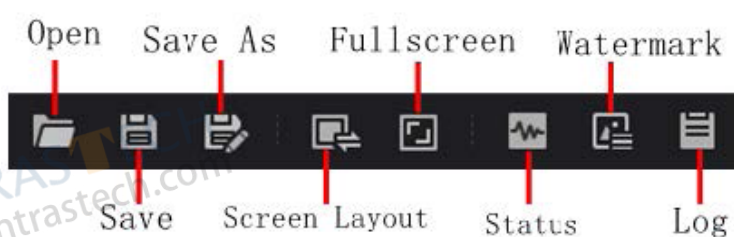

Software Operation

The meaning of shortcut icons in Device List is shown as below.

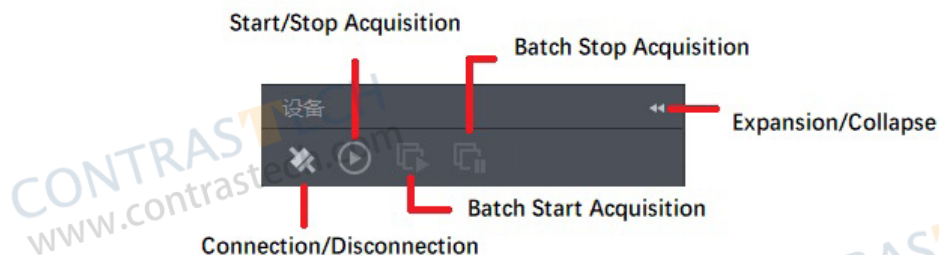

- Connection/Disconnection: After you selecting the camera, click "Connect" to connect the camera; click "Disconnect" to disconnect the camera.
- Start/Stop Acquisition: For current connected camera, click "Start Acquisition" to acquire image data; click "Stop Acquisition" to stop image data acquisition.
- Batch Start Acquisition: click "Batch Start Acquisition" to start image data acquisition for all currently connected camera by iDatum.
- Batch Stop Acquisition: click "Batch Stop Acquisition" to stop image data acquisition for all currently connected camera by iDatum.
- Expansion/Collapse: This function can be used to expand or collapse the Device List and Device Information which list on the left side of iDatum, and the default state is expansion. In the "Collapse" state, the iDatum left side only display the searched cameras.

- 2、Click in device list  to search the device.
- 3、Select a device to be connected.
- 4、Right click the device, and click Modify IP.
- 5、Set the IP address of the device in the same network segment with the PC
- 6、Click OK.

Click ">" in the camera's feature panel to unfold the specific camera parameters, and set them according to actual demands. Please see the table below for the introduction of each attribute classification.

Attribute	Description
<i>Device Control</i>	You can view the device information, edit its name, reset the device, etc.
<i>Image Format Control</i>	You can view and set the device's resolution, image reverse function, pixel format, region of interest, test pattern, etc.
<i>Acquisition Control</i>	You can view and set the device's acquisition mode, frame rate, trigger mode, exposure time, etc.
<i>Analog Control</i>	You can view and set the device's gain, black level, Gamma correction, sharpness, etc.
<i>LUT Control</i>	You can view the Look-Up Table (LUT), and set its index and value.
<i>Shading Correction</i>	You can set shading correction to correct shade.
<i>Digital IO Control</i>	You can set the different input and output signals.
<i>Action Control</i>	You can view and set the device's action control related parameters.
<i>Counter And Timer Control</i>	You can view and set the counter related parameters.
<i>File Access Control</i>	You can view and set the device's file access control related parameters.
<i>Sequencer Control</i>	You can view and set the device's sequencer related parameters.
<i>Event Control</i>	You can view and set the device's event control related parameters to let the device generate an event and transmit a related event message to the computer.
<i>Chunk Data Control</i>	You can view and set the device's chunk data control related parameters to generate supplementary image data and append that data to every image that you acquire.
<i>Transport Layer Control</i>	You can view and set the parameters of the device's transport layer.
<i>User Set Control</i>	You can save or load the device's parameters.



The camera's attribute tree and parameters may differ by camera models.

CHAPTER 4 CAMERA FEATURES

Non-Overlap Exposure and Overlap Exposure

The process that camera captures one frame of image includes two stages, exposure and readout. According to the overlap relation between the exposure time and the readout time, cameras with different sensors can be divided into overlap exposure and non-overlap exposure. Compared with non-overlap exposure, overlap exposure can reduce the influence of exposure time on grabbing time.

The products mentioned in this manual use overlap exposure to process image data.

■ Non-Overlap Exposure

After completing the current frame's exposure and readout, the next frame starts to expose and read out. This process is called non-overlap exposure. The non-overlap exposure's frame period is larger than the sum of the exposure time and the readout time, as shown below.

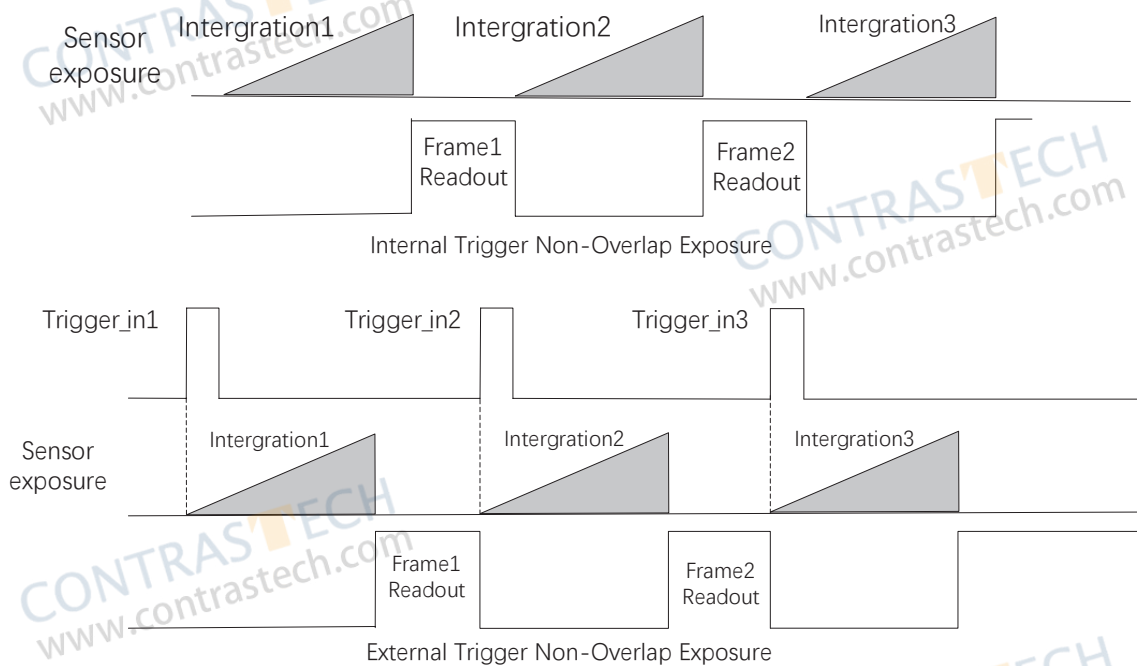

The camera will ignore the external signal in the readout section under this mode.

Non-Overlap Exposure and Overlap Exposure

Overlap Exposure

Overlap exposure refers to the overlap between the current frame exposure and the previous frame readout. In other words, when the previous frame starts to read out, the current frame starts to expose simultaneously, as shown below.

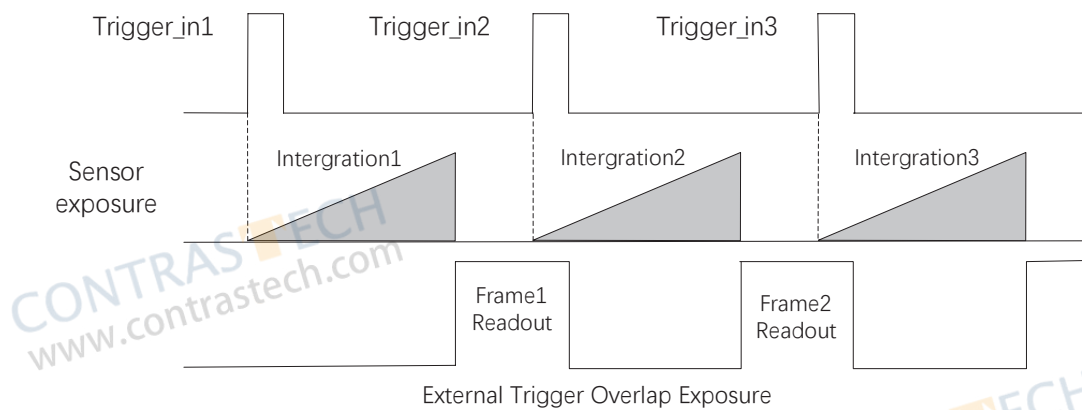
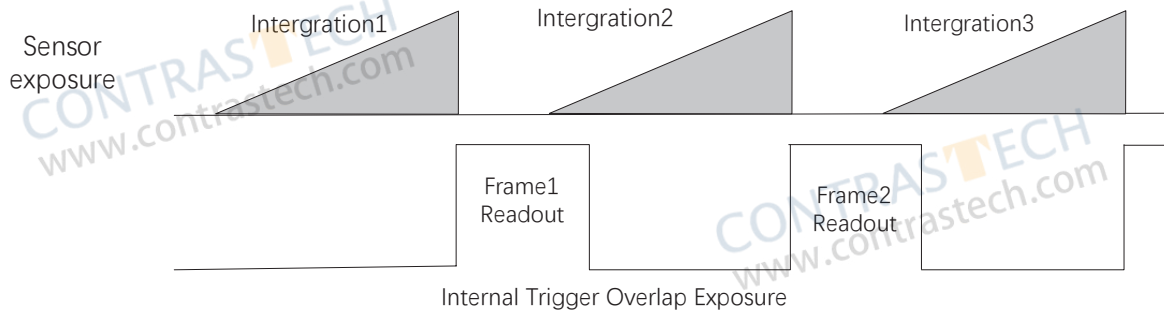

The camera will ignore the external signal in the readout section under this mode.

CHAPTER 5 IMAGE ACQUISITION

Frame Rate

Frame rate refers to the image number that is acquired by the camera per second. The higher frame rate, and shorter time used for image acquisition will be.

The following 4 factors determines the camera's frame rate in real-time.

- **Frame readout time:** The frame readout time is related with camera's sensor performance and image height. The lower the image height and less the frame readout time, and the higher the frame rate will be.
- **Exposure time:** If the reciprocal of max frame rate that the camera supports is t , and when the configured exposure time is larger than t , the less the exposure time, the higher the frame rate will be. When the configured exposure time is less than or equal to t , exposure time will not influence the frame rate.
- **Bandwidth:** The larger the bandwidth, the higher the frame rate will be.
- **Pixel format:** The more bytes pixel format occupy, the lower the frame rate will be.

The camera can also manually control the real-time frame rate.

The specific steps are as follows:

1. Click Acquisition Control > Acquisition Frame Rate, enter Acquisition Frame Rate according to actual demands, and enable Acquisition Frame Rate Control Enable.

_If the current real-time frame rate is smaller than configured frame rate, the camera acquires images according to the real-time frame rate.

_If the current real-time frame rate is larger than configured frame rate, the camera acquires images by the value you set.

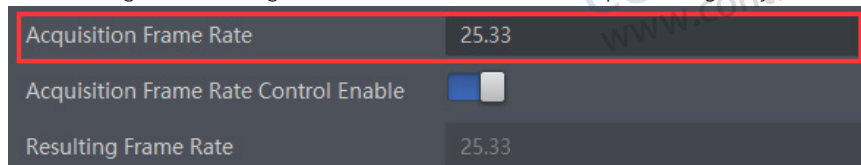

2. You can refer to Resulting Frame Rate to view the camera's resulting frame rate.

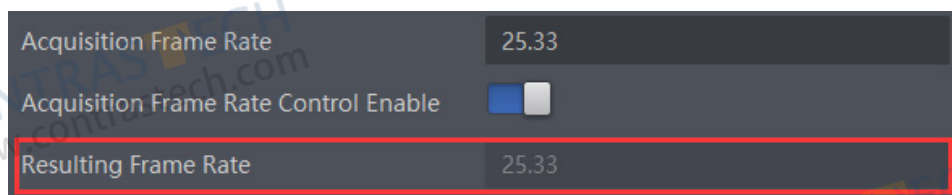

Overlap Mode



The overlap mode may differ by device models.
Refer to section Non-Overlap Exposure and Overlap Exposure for detailed introduction.

Go to Acquisition Control → Overlap Mode, select On as Overlap Mode to have overlap exposure, and select Off as Overlap Mode to have non-overlap exposure.

Trigger Mode

The camera has 2 types of trigger mode, including internal trigger mode and external trigger mode.

Internal trigger mode(acquisition modes), including SingleFrame mode and Continuous mode;external trigger mode, including software trigger, hardware trigger.

Trigger Mode	Parameter	Parameter Value	Principle
Internal trigger mode	Acquisition Control > Trigger Mode	Off	The camera acquires images via its internal signals.
External trigger mode		On	The camera acquires images via external signals. These signals can be software signal and hardware signal, including software trigger, hardware trigger, counter trigger, etc..

Internal trigger mode

Their principle and parameter setting are shown below.

Internal trigger mode	Parameter	Parameter Value	Principle
SingleFrame mode	Acquisition Control > Acquisition Mode	SingleFrame	When camera starts image acquisition, it acquires one image only, and then stops.
Continuous mode		Continuous	When camera starts image acquisition, it acquires images continuously. Real-time frame rate decides the acquisition frame number per second. You can stop camera image acquisition manually.

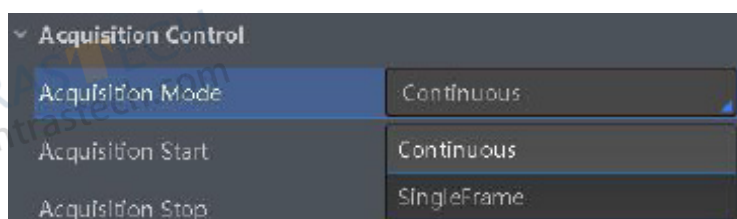

External trigger mode

The external trigger signals types of trigger camera acquisition can be given by software or external device. Under external trigger signal mode, the camera output image via following several working modes: SingleFrame Trigger mode, Burst Trigger mode and Long Exposure Trigger mode.

External Trigger Source

There are 5 types of external trigger sources, including software trigger, hardware trigger, counter trigger, action command trigger, and Free Trigger. Their principle and parameter setting are shown below.

External trigger mode	Parameter	Parameter Value	Principle
Software Trigger	Acquisition Control > Trigger Source	Software	The software sends trigger signal to the camera via GigE interface to acquire images.
Hardware Trigger		Line 0 / Line 2	External device connects camera via camera I/O interface. External device sends trigger signal to camera to acquire images.
Counter Trigger		Counter 0	The counter sends trigger signal to the camera to acquire images.
Action Command Trigger		Action 1	The action command sends trigger signal to the camera to acquire images.
Free Trigger		Anyway	Use software trigger, hardware trigger, counter or action command to send trigger signal to the camera to acquire images.

Click Acquisition Control > Trigger Source, and select Trigger Source according to actual demands.



These 5 external trigger sources are valid only when the Trigger Mode is On

Trigger Mode

■ Software Trigger

For the camera support software trigger mode, when user set software trigger, the client software can send commands to camera to acquires and transfer images via Gigabit Ethernet.

1. Click Acquisition Control > Trigger Mode, and select On as Trigger Mode.
2. Select Software as Trigger Source, and click Execute in Trigger Software to send trigger commands.

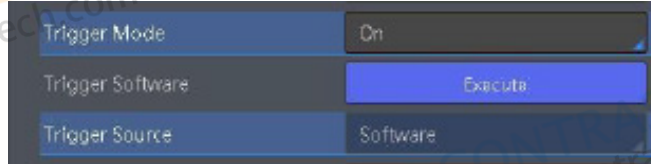

■ Hardware Trigger

If set "Hardware" as "Trigger Source" can switched to hardware external trigger mode.

The camera has 1 Opto-isolated input (Line 0), and 1 bi-directional I/O (Line 2) that can be configured as input signal, The setting of Line 2 as input signal is as shown below:

1. Click Digital IO Control.
2. Select Line 2 as Line Selector, and Input as Line Mode to set line 2 as input signal.

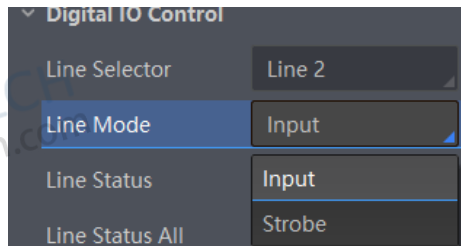

3. Click Acquisition Control, select On as Trigger Mode, select Line 0 or Line 2 as Trigger Source as shown in the figure below. The command to trigger the photo is given to the camera by the external device.

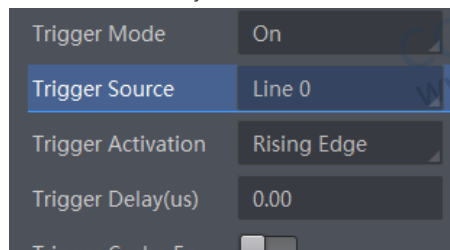

For details about the electrical characteristics and wiring of the IO interface, please refer to Chapter I/O Electrical Characteristics and Wiring.

Trigger Mode

■ Counter Trigger

The counter trigger provides frequency division to the external trigger signal. The camera performs an external trigger after receiving multiple hardware trigger signals.

1. Click Acquisition Control > Trigger Mode, and select On as Trigger Mode.
2. Select Counter 0 as Trigger Source.

When using counter as trigger source, you need to set relevant parameters under Counter And Timer Control. For specific parameter function and setting, please refer to the following table.

Parameter	Read/Write	Description
Counter Selector	Read and write	It selects counter source. Counter 0 is available only at present.
Counter Event Source	Read and write	It selects the signal source of counter trigger. Line 0 and Line 2 are available. It is disabled by default.
Counter Reset Source	Read and write	It selects the signal source of resetting counter. Software is available only. It is disabled by default.
Counter Reset	Write is available under certain condition	It resets counter and it can be executed when selecting Software as Counter Reset Source.
Counter Value	Read and write	It is the counter value with the range of 1 to 1023. For example, if the parameter is set to n, then the trigger signal n times can execute the counter trigger once to obtain 1 frame of image.
Counter Current Value	Read only	It displays the number of executed external trigger.

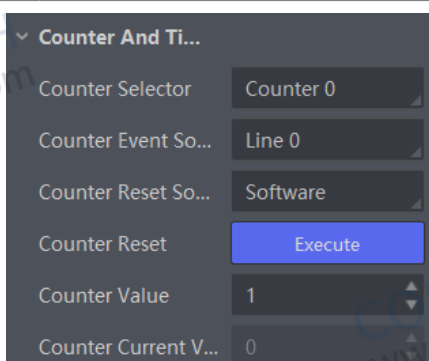

■ Action Command Trigger

When you need to use the function of action commands, you should set action command trigger first.

1. Click Acquisition Control > Trigger Mode, and select On as Trigger Mode.
2. Select Action 1 as Trigger Source.

■ Free Trigger

In the free trigger mode, the camera can receive signals from software trigger, hardware trigger, action command trigger, and counter trigger.

1. Click Acquisition Control > Trigger Mode, and select On as Trigger Mode.
2. Select Anyway as Trigger Source.

Trigger Mode

Trigger Related Parameters

In external trigger mode, you can set five related parameters, including acquisition burst frame count, trigger activation, trigger delay, trigger cache, and trigger debouncer.. Different trigger sources can set various trigger parameters, and their relation is shown below.

Trigger Source \ Trigger Parameter	Software Trigger	Hardware Trigger	Counter Trigger	Action Command Trigger	Anyway Trigger
Burst Frame Count	√	√	√	√	√
Trigger Delay	√	√	√	√	√
Trigger Cache Enable	√	√	√	√	√
Trigger Activation	×	√	√	×	√
Trigger Debouncer	×	√	√	×	Partially Supported



- Different trigger sources can set various parameters in external trigger mode.
- In hardware, counter or free trigger, you can set all five parameters mentioned above.
- In software or action command trigger, you can set acquisition burst frame count, trigger delay, and trigger cache only.

Burst Frame Count

In external trigger mode, you can set acquisition burst frame count.

Click Acquisition Control > Acquisition Burst Frame Count, and enter Acquisition Burst Frame Count according to actual demands. Its range is from 1 to 1023.

Acquisition Burst Frame Count 1

When Acquisition Burst Frame Count is 1, it is in single frame trigger mode. When Acquisition Burst Frame Count is larger than 1, it is in multi-frame trigger mode. If Acquisition Burst Frame Count is n and when inputting 1 trigger signal, the camera stops acquiring images after exposing n times and outputs n frame images. The sequence diagram of burst frame count is shown below.

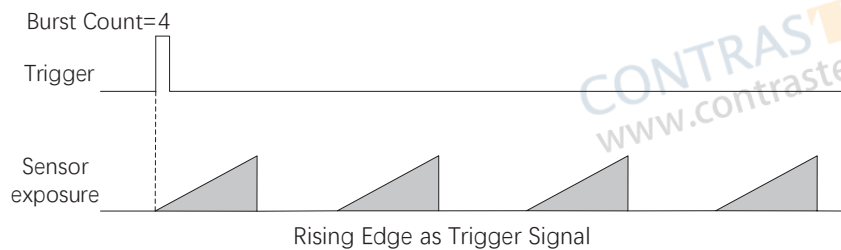

Trigger Delay

The trigger delay function allows the device to add a delay between the receipt of trigger signal and the moment the trigger becomes active. Click Acquisition Control > Trigger Delay, and enter Trigger Delay, and the unit is μs .

Its sequence diagram is shown below.

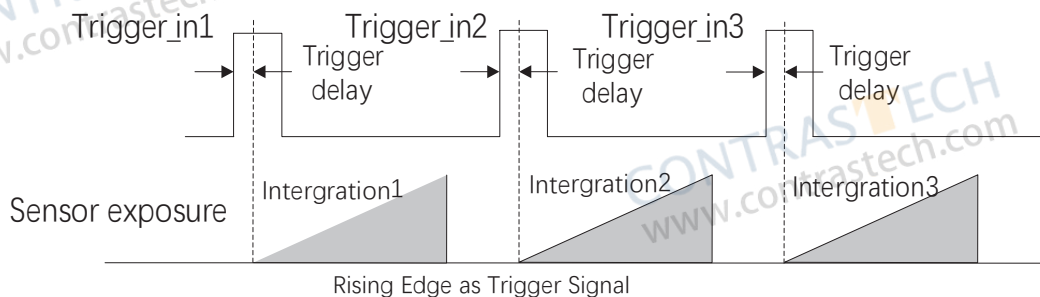

You can set proper value in Trigger Delay, and its range is from 0 μs to 16000000 μs .

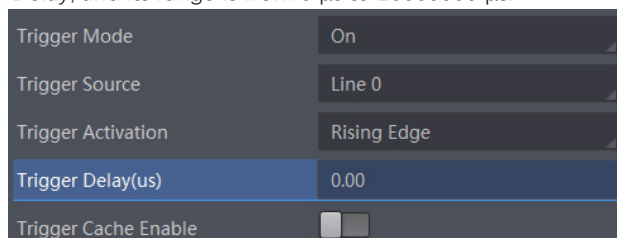

Trigger Mode

■ Trigger Cache Enable

The trigger cache function allows the device to save and process new signal during trigger stage, and the device can save and process three trigger signals at most.

Click Acquisition Control > Trigger Cache Enable, and enable Trigger Cache Enable.

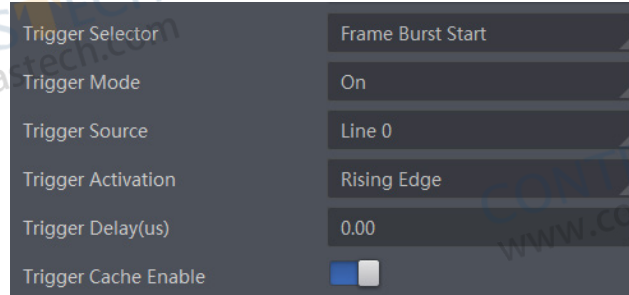

For example, if the device receives the 2nd trigger signal when it is processing the 1st trigger signal, and the result will be different depending on whether Trigger Cache Enable is enabled or not.

- The 2nd trigger signal will be filtered without processing if Trigger Cache Enable is disabled.

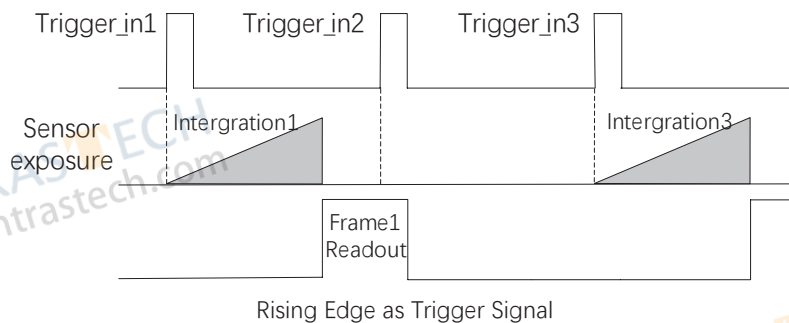

- The 2nd trigger signal will be saved if Trigger Cache Enable is enabled.

_ If the 1st frame image's exposure time of the 2nd trigger signal is not earlier than the device's last frame creation time of the 1st trigger signal, and then the 2nd trigger signal's 1st frame image is created normally.

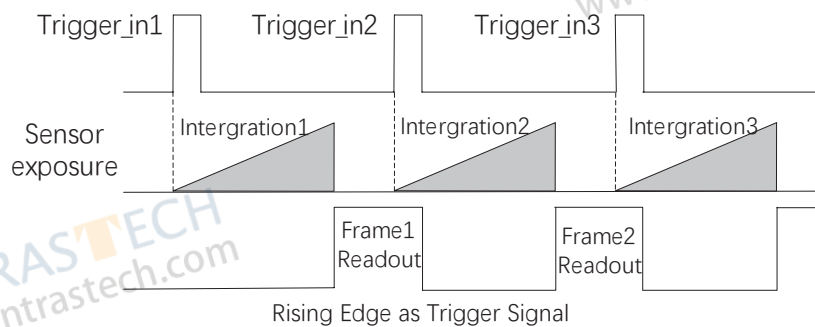

_ If the 1st frame image's exposure time of the 2nd trigger signal is earlier than the device's last frame creation time of the 1st trigger signal, and then the device will delay this exposure time. Thus making sure this exposure time is not earlier than the device's last frame creation time of the 1st trigger signal.

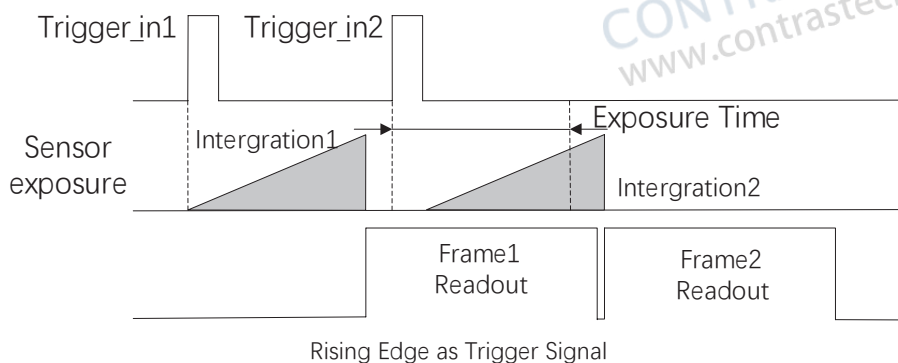

Trigger Mode

■ Trigger Activation

The camera supports trigger acquisition in the rising edge, falling edge, level high, or level low of the external signal. The principle and parameter of trigger activation are shown below.

Trigger Activation	Parameter	Parameter Value	Principle
Rising Edge	Acquisition Control > Trigger Activation	Rising Edge	Rising Edge refers to the rising edge of the trigger signal is valid, that is camera exposure and acquisition at the beginning of the rising edge of the trigger signal.
Falling Edge		Falling Edge	Falling Edge refers to the falling edge of the trigger signal is valid, that is camera exposure and acquisition at the beginning of the falling edge of the trigger signal.
Level High		Level High	Level High refers to the level high of the trigger signal is valid. As long as trigger signal is in level high, the camera keeps exposure and acquisition status.
Level Low		Level Low	Level Low refers to the level low of the trigger signal is valid. As long as trigger signal is in level low, the camera keeps exposure and acquisition status.

Click Acquisition Control > Trigger Activation, and select Rising Edge, Falling Edge, Level High or Level Low as Trigger Activation according to actual demands.

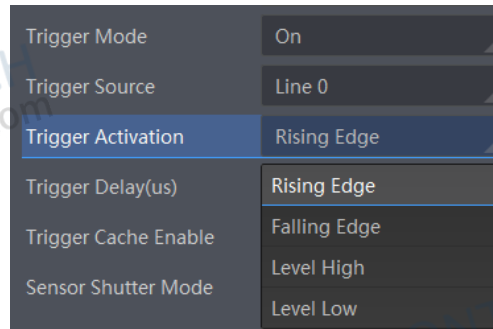

■ Trigger Debouncer

The trigger debouncer function allows the device to filter out unwanted short external trigger signal that is input to the device. Click Digital IO Control > Line Debouncer Time, enter Line Debouncer Time, and its range is from 1 μ s to 1000000 μ s.

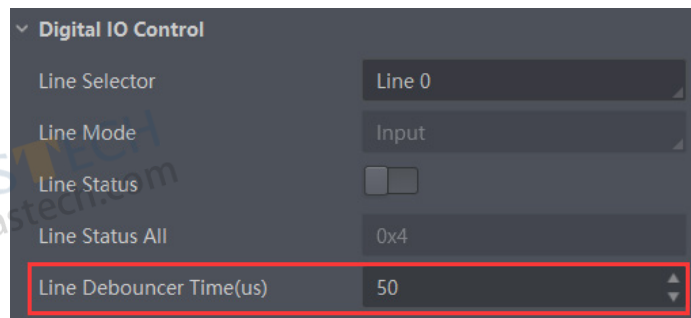

When the set Debouncer time is greater than the trigger signal time, the trigger signal is ignored.

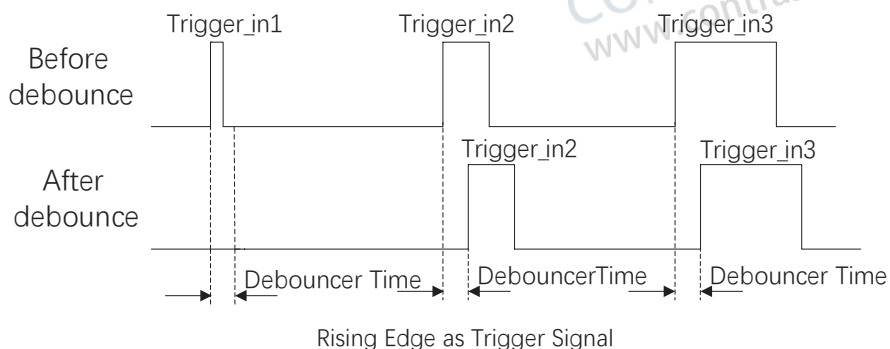

CHAPTER 6 I/O OUTPUT

Select Output Signal

The camera has 1 opto-isolated output (Line 1), and 1 bi-directional I/O (Line 2) that can be configured as output signal. Here we take Line 2 as an example.

Click Digital IO Control, select Line 2 as Line Selector, and select Strobe as Line Mode to set line 2 as output signal.

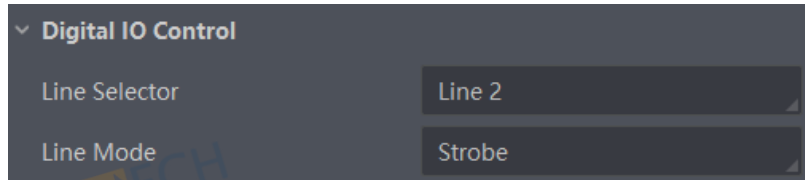

For details about the electrical characteristics and wiring of the IO interface, please refer to Chapter I/O Electrical Characteristics and Wiring.

Set Output Signal

The output signal of the camera is switch signal that can be used to control external devices such as light source, PLC, etc. There are two ways to set output signal, including line inverter and strobe signal.

■ Enable Line Inverter

The line inverter function allows the camera to invert the electrical signal level of an I/O line, and meets requirements of different devices for high or low electrical signal level. All high signals are converted to low signals and vice versa.

Click Digital IO Control > Line Selector, select line for Line Selector, and enable Line Inverter.

The Line Inverter parameter is disabled by default.

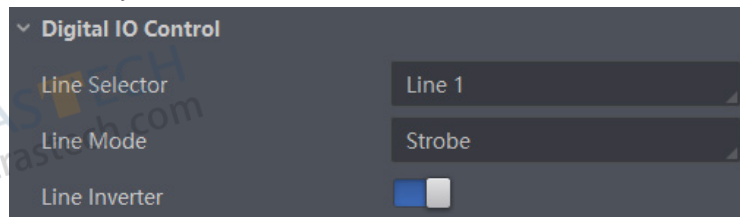

■ Enable Strobe Signal

The strobe signal is used to directly output I/O signal to external devices when camera's event source occurs.

Click Digital IO Control, select different output events as Line Source, and enable Strobe Enable.

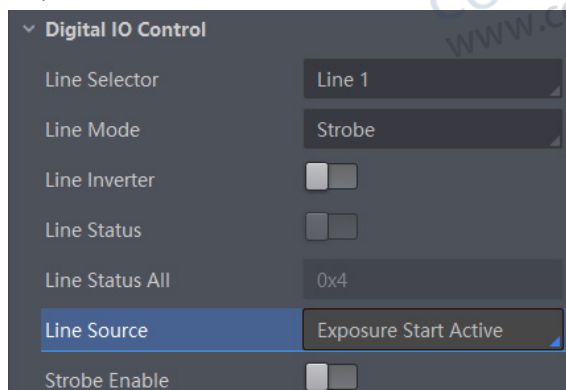

Set Output Signal

For specific Line Source, please refer to following table for details.

Name	Description
Exposure Start Active	The device outputs signals to external devices when it starts exposure.
Exposure End Active	The device outputs signals to external devices when it stops exposure.
Acquisition Start Active	The device outputs signals to external devices when it starts acquiring images.
Acquisition Stop Active	The device outputs signals to external devices when it stops acquiring images.
Frame Burst Start Active	The device outputs signals to external devices when the device's frame burst starts.
Frame Burst End Active	The device outputs signals to external devices when the device's frame burst stops.
Frame Trigger Wait	The device is currently waiting for a frame start trigger.
Frame Start Active	The device outputs signals to external devices when it starts doing the capture of a frame.
Frame End Active	The device outputs signals to external devices when it stops doing the capture of a frame.
Soft Trigger Active	The device outputs signals to external devices when it has a software trigger.
Hard Trigger Active	The device outputs signals to external devices when it has a hardware trigger.
Counter Active	The device outputs signals to external devices when it has a counter trigger.
Timer Active	The device outputs signals to external devices when it has a timer trigger.

If Timer Active is selected as Line Source, you can click Execute in Line Trigger Software, and enter Strobe Line Delay according to actual demands. The device will output signals whose duration is configured in Strobe Line Duration.

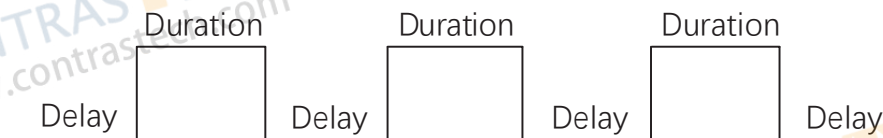
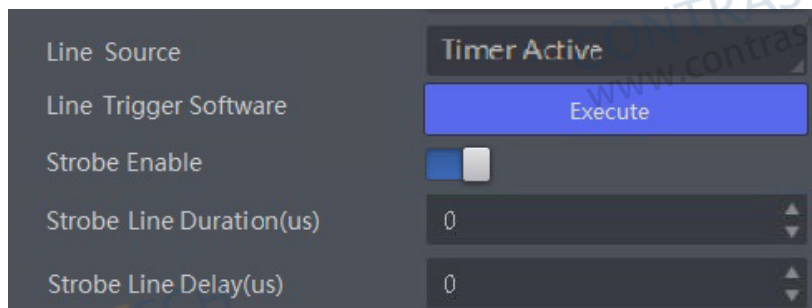

The specific line source may differ by camera models.

Set Output Signal

■ Strobe Line Duration

After enabling strobe signal, you can set its duration. Click Digital IO Control > Strobe Line Duration, and enter it according to actual demands.

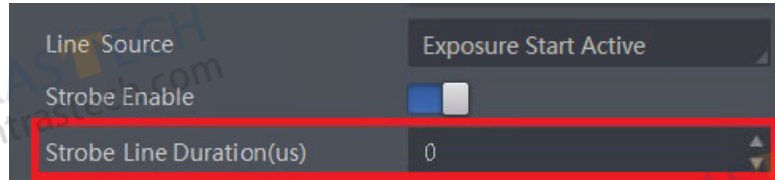

For example, select Line Source as Exposure Start Active. When the camera starts to expose, Strobe outputs immediately. When the Strobe Line Duration value is 0, the strobe duration is equal to the exposure time. When the Strobe Line Duration value is not 0, the strobe duration is equal to Strobe Line Duration value.

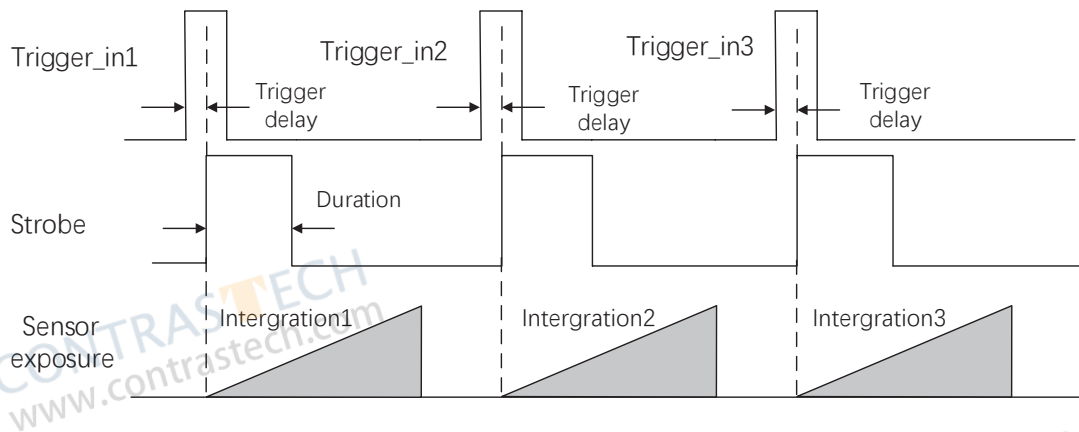

■ Strobe Line Delay

The camera supports setting strobe line delay to meet actual demands. When exposure starts, the strobe output doesn't take effect immediately. Instead, the strobe output will delay according to the strobe line delay setting.

Click Digital IO Control > Strobe Line Delay, and enter Strobe Line Delay according to actual demands. The range of Strobe Line Delay is from 0 μ s to 10000 μ s.

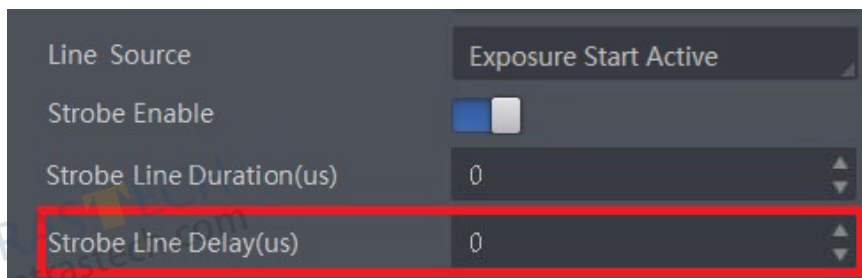

For example, select Line Source as Exposure Start Active.

When the camera starts to expose, the Strobe output does not take effect immediately, but delays the output according to the value set by Strobe Line Delay. The sequence diagram of strobe line delay is shown below.

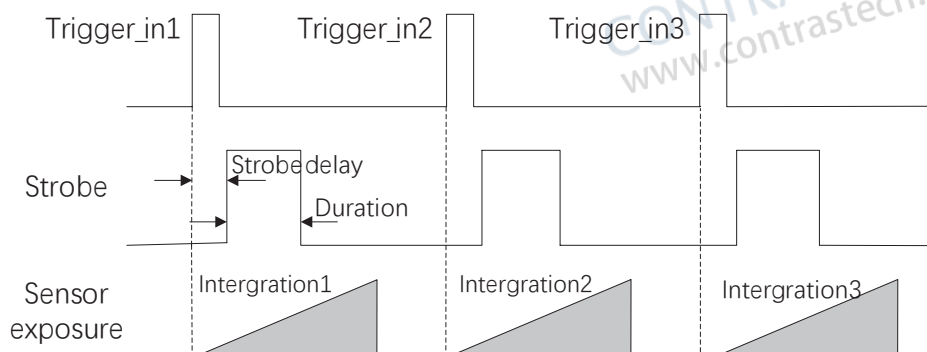

Set Output Signal

■ Strobe Line Pre Delay

The camera also supports the function of strobe line pre delay, which means that the strobe signal takes effect early than exposure. This function is applied to the external devices that have slow response speed.

Click Digital IO Control > Strobe Line Pre Delay, and enter Strobe Line Pre Delay according to actual demands.

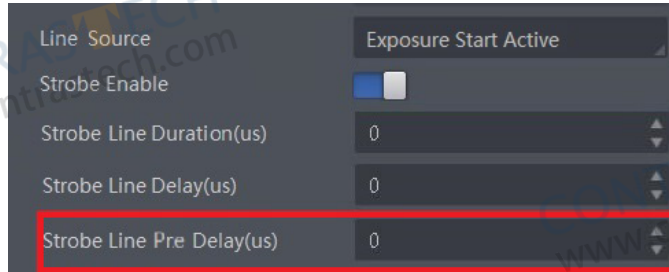

For example, select Line Source as Exposure Start Active.

The camera will delay the exposure according to the value set by Strobe Line Pre Delay. The sequence diagram of strobe line pre delay is shown below.

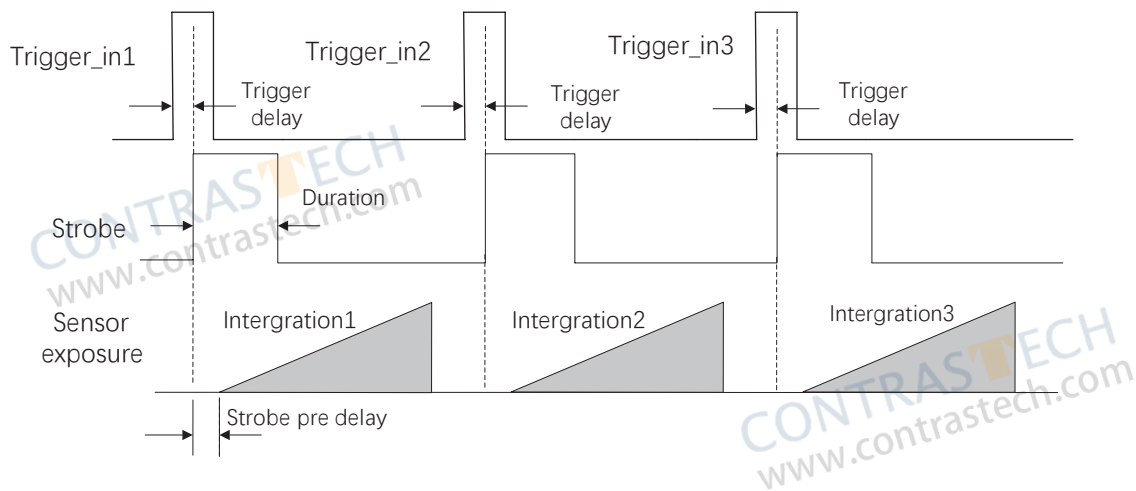

I/O ELECTRICAL FEATURE AND WIRING

CHAPTER 7

I/O Electrical Feature

Line 0 Opto-isolated Input Circuit

The Line 0 opto-isolated input circuit in camera I/O control is shown below.

The maximum input current of Line 0 is 25 mA.

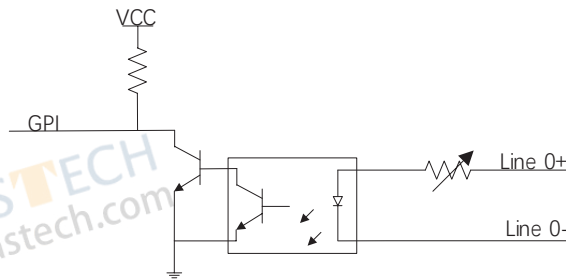

Input Logic Level:

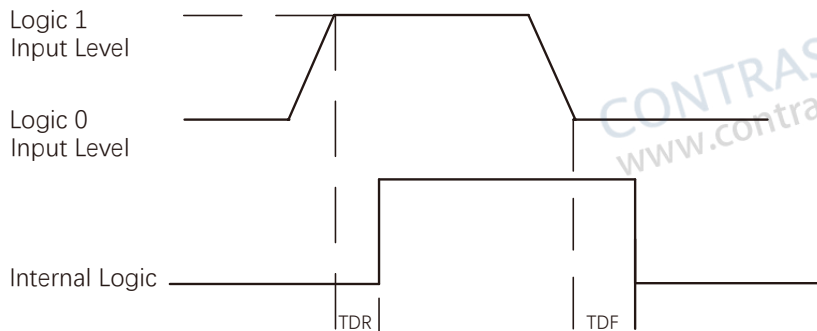

Input Electrical Feature:

Parameter Name	Parameter Symbol	Value
Input Logic Level Low	VL	0 ~ 1 VDC
Input Logic Level High	VH	3.3 ~ 24 VDC
Input Rising Delay	TDR	1.8 ~ 4.6 μ s
Input Falling Delay	TDF	16.8 ~ 22 μ s



- Make sure the input voltage is not from 1 VDC to 3.3 VDC as the electric status between these two values are not stable.
- The breakdown voltage is 30 VDC, and keep voltage stable.

I/O Electrical Feature

Line 1 Opto-isolated Output Circuit

The Line 1 opto-isolated output circuit in camera I/O control is shown below.

The maximum output current of Line 1 is 25 mA.

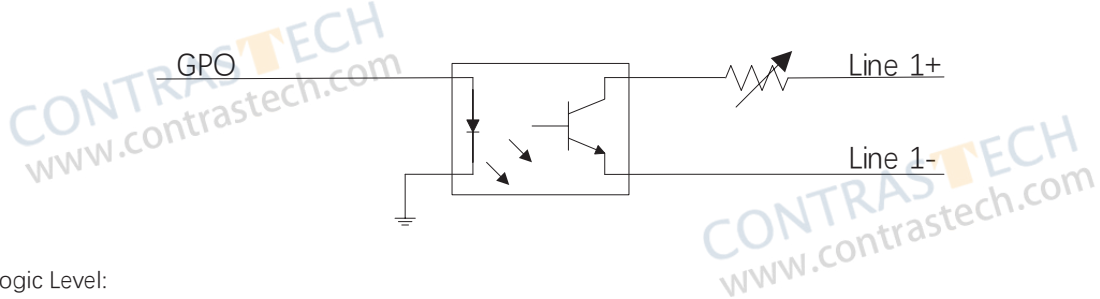

Output Logic Level:

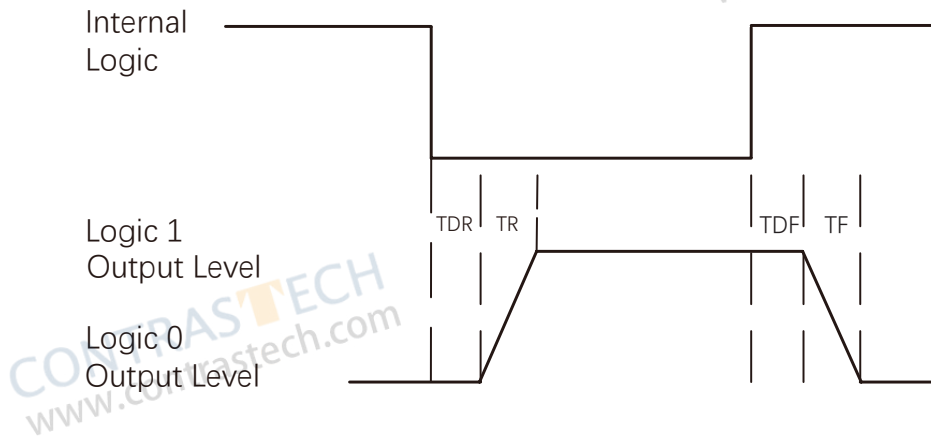

Opto-isolated output electric feature is shown in below (when the external voltage is 3.3 VDC and the external resistance is 1 K Ω).

Parameter Name	Parameter Symbol	Value
Output Logic Level Low	VL	575 mV
Output Logic Level High	VH	3.3 V
Output Rising Time	TR	8.4 μ s
Output Falling Time	TF	1.9 μ s
Output Rising Delay	TDR	15 ~ 60 μ s
Output Falling Delay	TDF	3 ~ 6 μ s

With different external voltage and resistance, the corresponding current and the parameter of output logic level low are shown below.

External Voltage	External Resistance	VL	Output Current
3.3 V	1 K Ω	575 mV	2.7 mA
5 V	1 K Ω	840 mV	4.1 mA
12 V	2.4 K Ω	915 mV	4.6 mA
24 V	4.7 K Ω	975 mV	4.9 mA

I/O Electrical Feature

Line 2 Non-isolated Bi-direction I/O Circuit

The Line 2 bi-direction I/O circuit in camera I/O control is shown below. The Line 2 can be configured as input signal or as output signal.

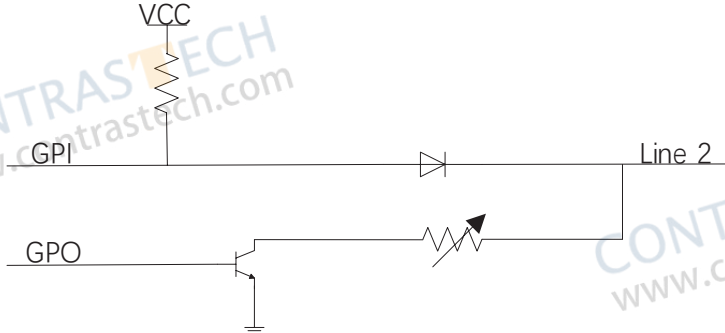

Line 2 Configured as Input

With the condition of 100 Ω and 5 VDC, the logic level and electrical feature of configuring Line 2 as output are shown below.

Input Logic Level:

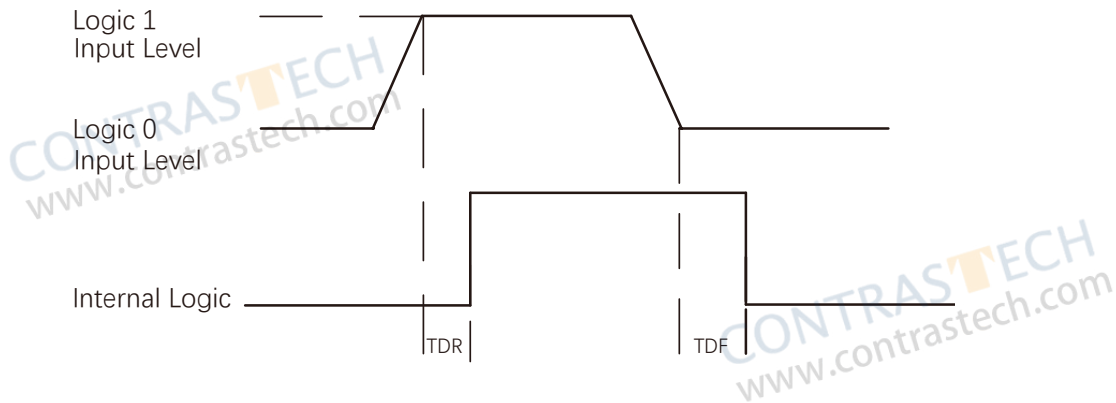

Electrical Feature of Line 2 Input:

Parameter Name	Parameter Symbol	Value
Input Logic Level Low	VL	0 ~ 0.3 VDC
Input Logic Level High	VH	3.3 ~ 24 VDC
Input Rising Time	TDR	< 1 μ s
Input Falling Time	TDF	< 1 μ s



- Make sure the input voltage is not from 0.3 VDC to 3.3 VDC as the electric status between these two values are not stable.
- The breakdown voltage is 30 VDC, and keep voltage stable.
- To prevent damage to the GPIO pin, please connect GND first and then input voltage in Line 2.

I/O Electrical Feature

■ Line 2 Configured as Output

The maximum current is 25 mA and the output impedance is 40 Ω .

The relation among external voltage, resistance and the output level low is shown below.

External Voltage	External Resistance	VL(GPIO2)
3.3 V	1 K Ω	160 mV
5 V	1 K Ω	220 mV
12 V	1 K Ω	460 mV
24 V	1 K Ω	860 mV
30 V	1 K Ω	970 mV

When the voltage of external resistance (1 K Ω) is pulled up to 5 VDC, the logic level and electrical feature of configuring Line 2 as output are shown below.

Output Logic Level:

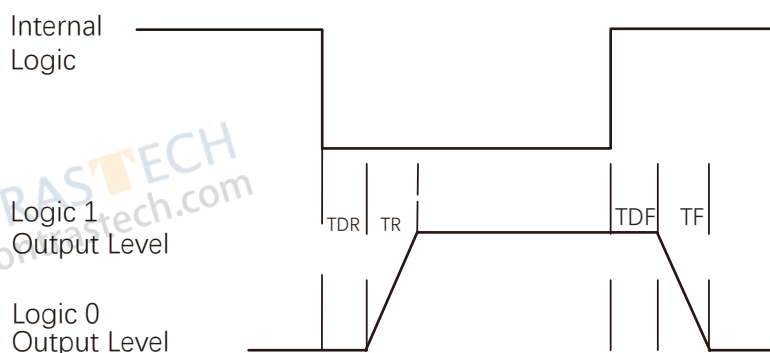

Electrical Feature of Line 2 Output:

Parameter Name	Parameter Symbol	Value
Output Logic Level Low	VL	220 mV
Output Logic Level High	VH	4.75 V
Output Rising Time	TR	0.06 μ s
Output Falling Time	TF	0.016 μ s
Output Rising Delay	TDR	0 ~ 4 μ s
Output Falling Delay	TDF	< 1 μ s

I/O Wiring

The camera has different appearance with varied models. Here we take type with TEC camera as an example to introduce I/O wiring. Other cameras can be analogized according to the cable definition in the wiring diagram, combined with the power supply and I/O interface definition chapter.



For specific camera appearance, cable color and I/O wiring, please refer to the actual one you got.

Line 0 Wiring

When the camera uses Line 0 as hardware trigger source, wirings are different with different external devices of input signal.

The input signal is PNP Device, that is, Line 0 Connecting to PNP Device:

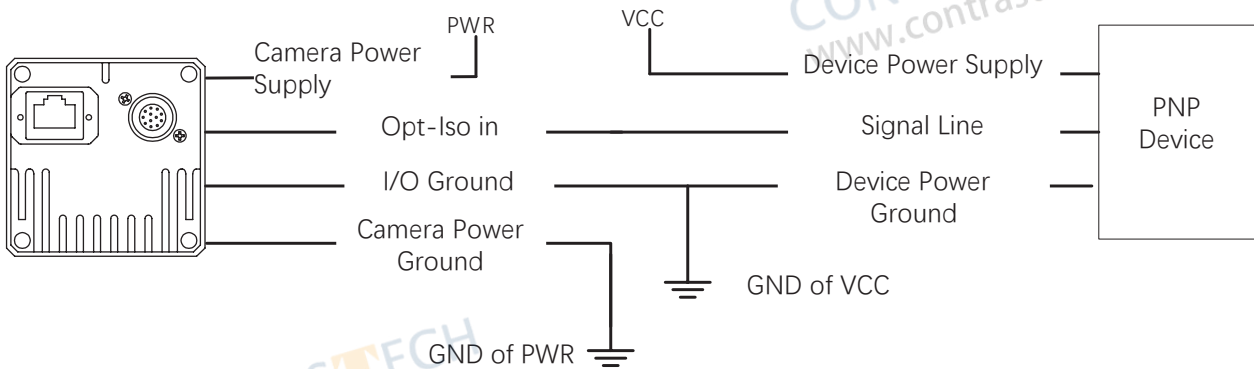

The input signal is NPN Device, that is, Line 0 Connecting to NPN Device:

_If the VCC of NPN device is 24 VDC, and it is recommended to use 4.7 K Ω pull-up resistor.

_If the VCC of NPN device is 12 VDC, and it is recommended to use 1 K Ω pull-up resistor.

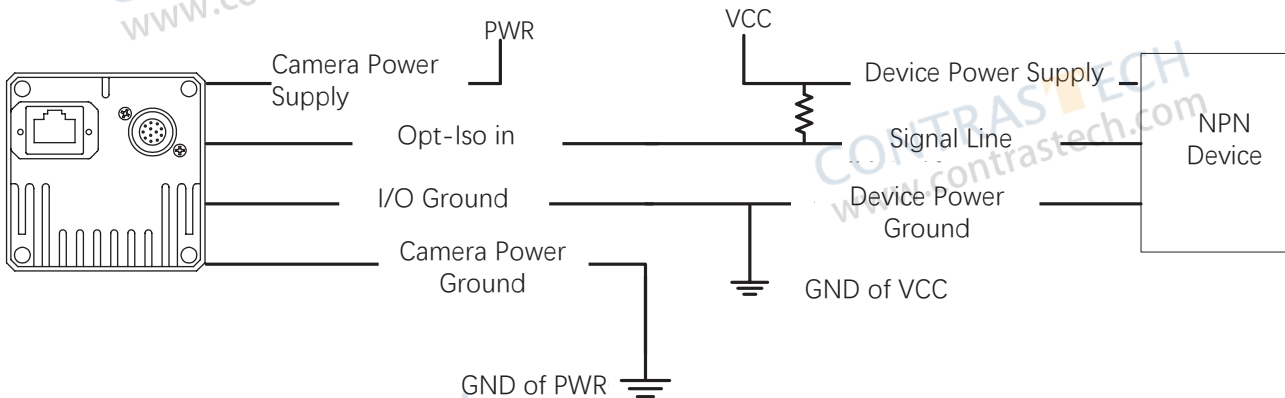

The input signal is Switch, that is, Line 0 Connecting to Switch:

If the VCC of switch is 24 VDC, and it is recommended to use 4.7 K Ω resistor to protect circuit.

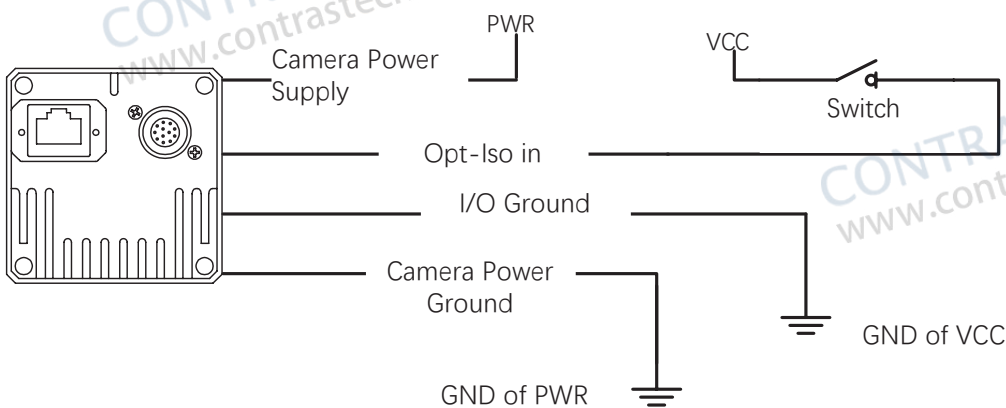

I/O Wiring

Line 1 Wiring

When the camera uses Line 1 as output signal, wirings are different with different external devices.

The external devices is PNP Device, that is, Line 1 Connecting to PNP Device:

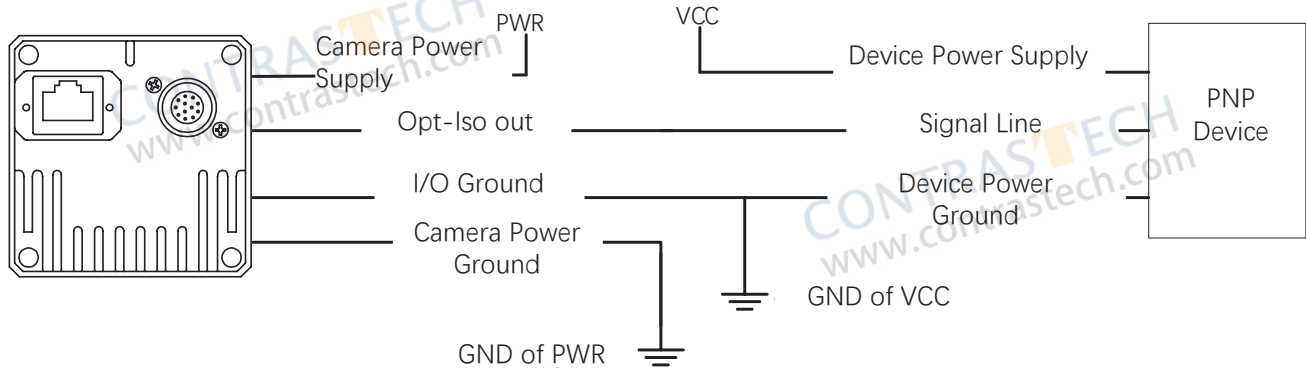

The external devices is NPN Device, that is, Line 1 Connecting to NPN Device:

_If the VCC of NPN device is 24 VDC, and it is recommended to use 4.7 K Ω pull-up resistor.

_If the VCC of NPN device is 12 VDC, and it is recommended to use 1 K Ω pull-up resistor.

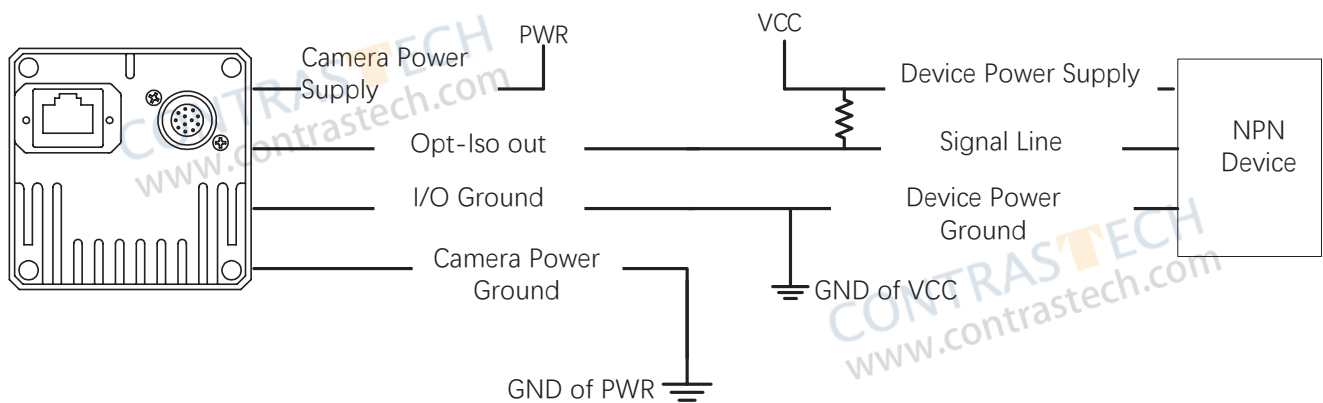

I/O Wiring

Line 2 Wiring

As bi-direction I/O Circuit, Line 2 can be used as both input signal and output signal.

Line 2 Configured as Input

When the camera uses Line 2 as hardware trigger source, wirings are different with different external devices of input signal.

The input signal is PNP Device, that is, Line 2 Connecting to PNP Device as Input:
It is recommended to use 330 Ω pull-down resistor.

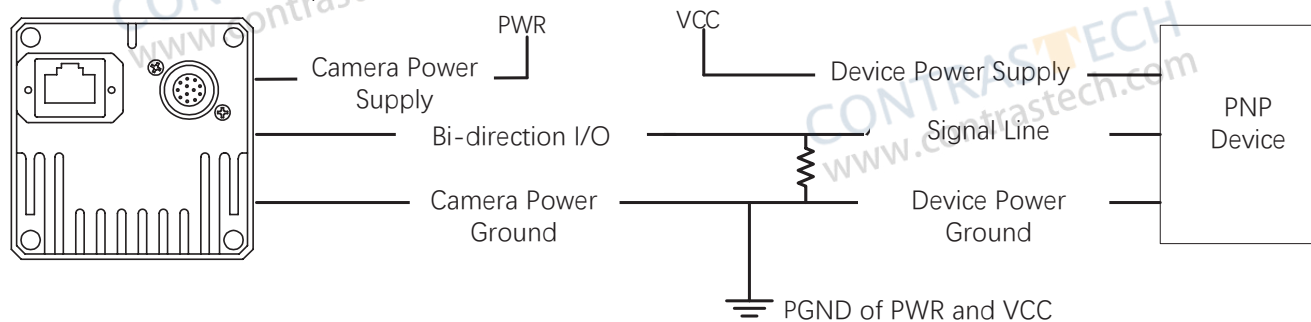

The input signal is NPN Device, that is, Line 2 Connecting to NPN Device as Input:
_If the VCC of NPN device is 24 VDC, and it is recommended to use 4.7 K Ω pull-up resistor.
_If the VCC of NPN device is 12 VDC, and it is recommended to use 1 K Ω pull-up resistor.

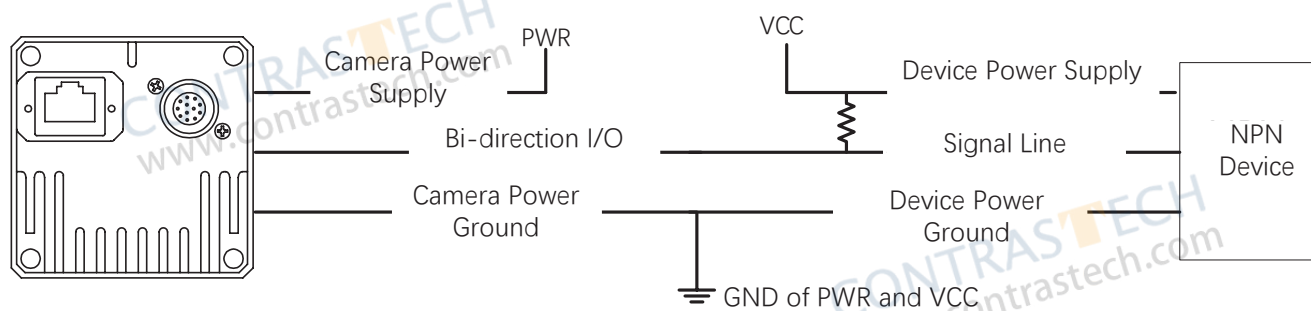

The input signal is Switch, that is, Line 2 Connecting to a Switch as Input:
The switch value can provide low electrical level to trigger line 2.

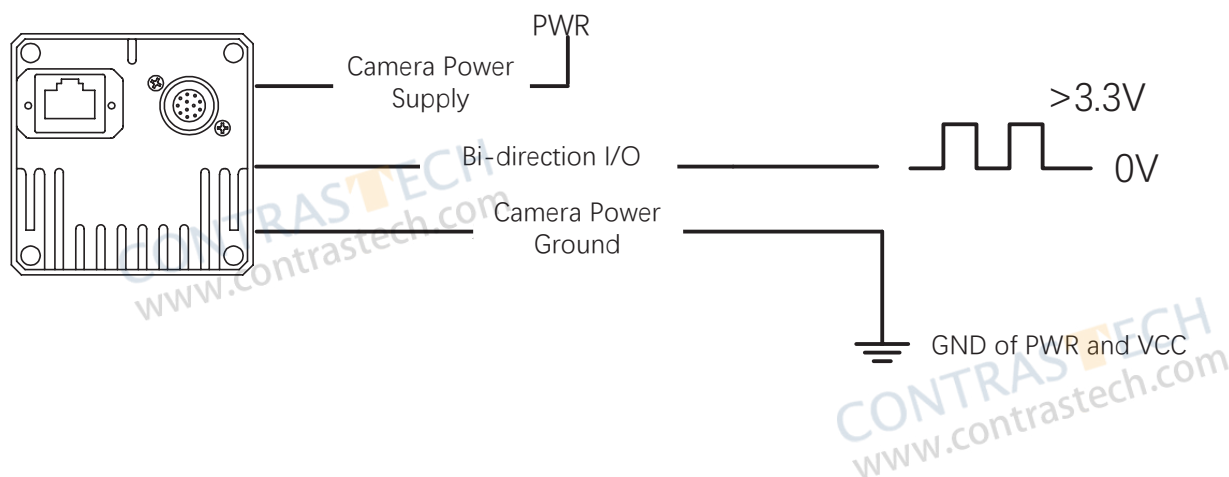

I/O Wiring

■ Line 2 Configured as Output

When the camera uses Line 2 as output signal, wirings are different with different external devices.

The external devices is PNP Device, that is, Line 2 Connecting to PNP Device as Output:

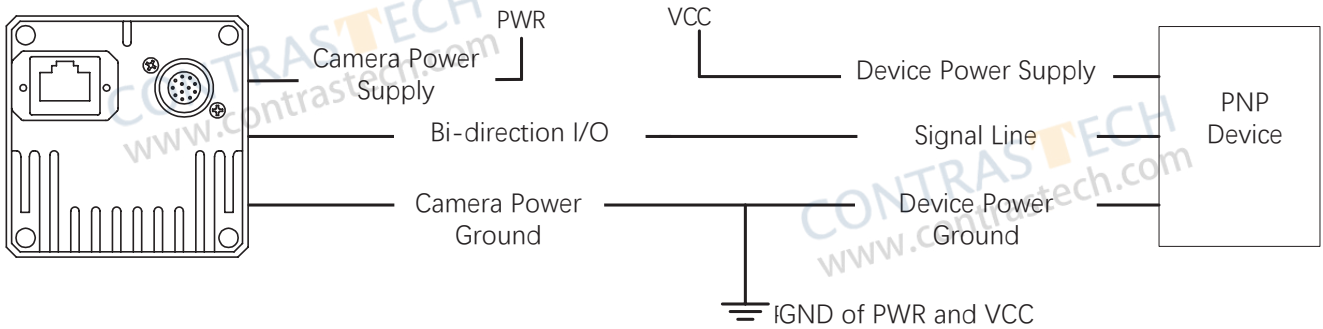

The external devices is NPN Device, that is, Line 2 Connecting to NPN Device as Output:

_If the VCC of NPN device is 24 VDC, and it is recommended to use 4.7 K Ω pull-up resistor.

_If the VCC of NPN device is 12 VDC, and it is recommended to use 1 K Ω pull-up resistor.

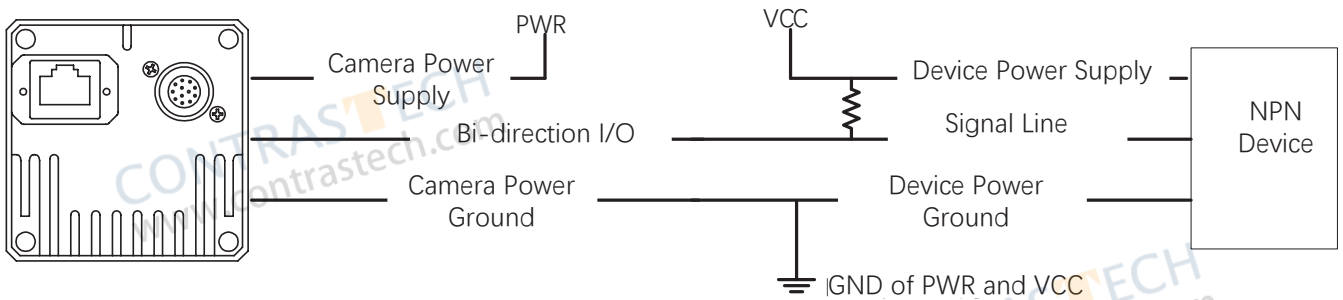

CHAPTER 8 IMAGE PARAMETER

Resolution and ROI

The camera displays the image with max.resolution by default. Click Image Format Control, and view Width Max and Height Max. Width Max stands for the max. pixels per inch in width direction and Height Max stands for the max. pixels per inch in height direction.

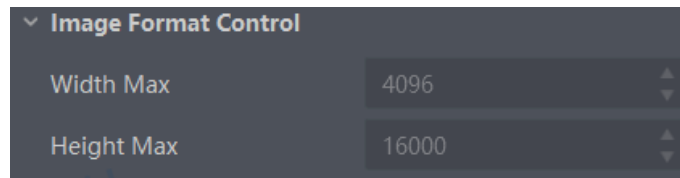

If you are only interested in a certain region of the image, you can set a Region of Interest (ROI) for the camera. Setting Region of Interest can reduce the bandwidth of the image being transmitted. Thus increasing the frame rate to some extent.



- The camera currently supports 1 ROI only, that is, there is Region 0 for Region Selector.
- ROI can be set only when you stop real-time acquisition.

Click Image Format Control > Region Selector, and enter Width, Height, Offset X, and Offset Y.

- Width: it stands for horizontal resolution in ROI area.
- Height: it stands for vertical resolution in ROI area.
- Offset X: it refers to the horizontal coordinate of the upper left corner of the ROI.
- Offset Y: it refers to the vertical coordinate of the upper left corner of the ROI.

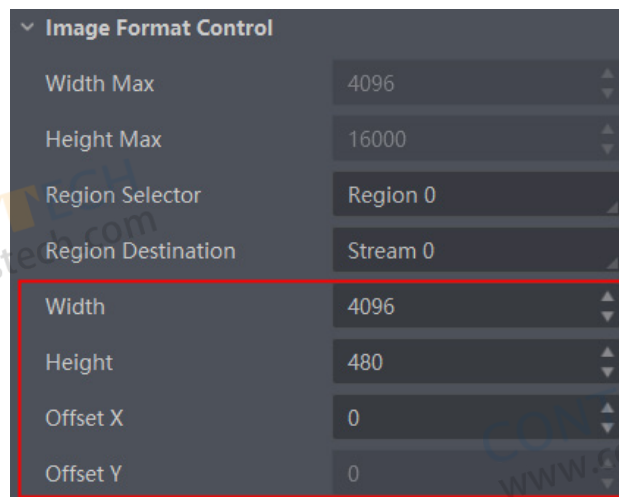

- The Width plus Offset X should not be larger than Width Max parameter, Height plus Offset Y should not be larger than Height Max.
- The ROI function may differ by camera models.

Image Reverse

There are two types of Image Reverse, Reverse X and Reverse Y. Reverse X refers to the image reverses in a horizontal way, and Reverse Y refers to the image reverses in a vertical way. The principle and parameter of Image Reverse are shown below.

Image Reverse	Parameter	Principle
Reverse X	Image Format Control > Reverse X	the image reverses in a horizontal way
Reverse Y	Image Format Control > Reverse Y	the image reverses in a vertical way

You can click Image Format Control, and enable Reverse X or Reverse Y according to actual demands.

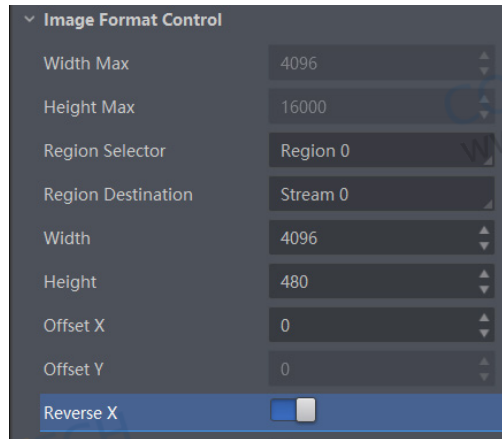

- For different models of device, the image reverse function may be different, please refer to the actual one you got.
- Only when the device stops streaming, you can enable Reverse Y.

Pixel Format

This function allows you to set the pixel format of the image data transmitted by the camera.

Pixel Format	Pixel Size(Bits/Pixel)
Mono 8, Bayer 8	8
Mono10 Packed、Mono 12 packed	12
Mono 10/12	16

Click Image Format Control > Pixel Format, and set Pixel Format according to actual demands.

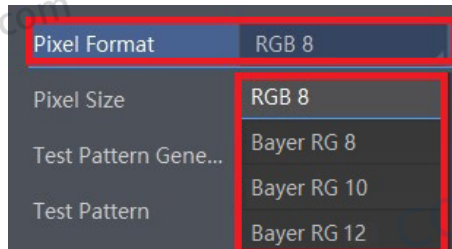

- The specific pixel formats may differ by device models.

Test Pattern

The camera supports test pattern function. When there is exception in real-time image, you can check whether image of test mode have similar problem to determine the reason. This function is disabled by default, and at this point, the outputted image by the camera is real-time image. If this function is enabled, the outputted image by the camera is test image.

Click Image Format Control > Test Pattern, and set Test Pattern according to actual demands

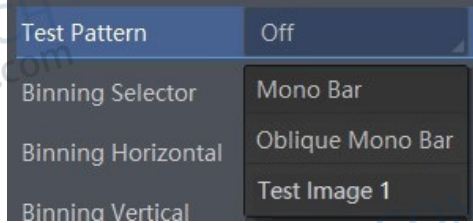

The camera offers 3 test patterns, including Mono Bar, Oblique Mono Bar and Test Image 1.

i The pattern of the test image 1 may differ by camera models.



Fig:Mono Bar



Fig:Oblique Mono Bar

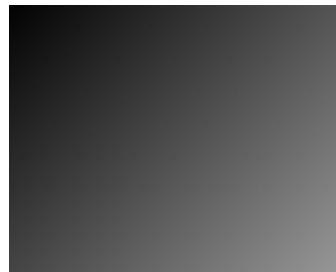

Fig:Test Image 1

Binning

The purpose of setting binning is to enhance sensibility. With binning, multiple sensor pixels are combined as a single pixel to reduce resolution and improve image brightness.

Click Image Format Control, and set Binning Horizontal and Binning Vertical according to actual demands.

Binning Horizontal is the image's width, and Binning Vertical is the image's height.

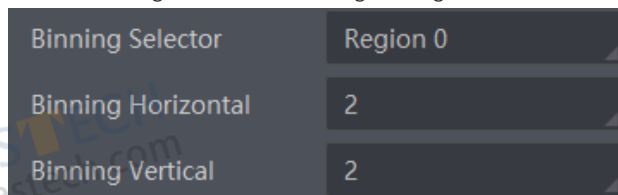

i The binning function may differ by camera models.

The device also supports binning mode function if the binning is 2 × 2 and above. The binning mode defines how pixels are combined if the binning is 2 × 2 and above. Click Binning Mode, and select Sum or Average according to actual demands.

- Sum: The values of the affected pixels are summed. This improves the signal-to-noise ratio, but also increases the device's response to light.
- Average: The values of the affected pixels are averaged. This greatly improves the signal-to-noise ratio without affecting the device's response to light.

Both binning modes (Sum and Average) reduce the amount of image data to be transferred.

i Configuring binning mode is supported when the device is acquiring images.

Exposure Mode

The exposure mode may differ by device models.

The device supports 2 types of exposure modes, including Timed and Trigger Width.

- If the Exposure Mode is Timed, the device's exposure time is controlled by Exposure Auto and Exposure Time.
- If the Exposure Mode is Trigger Width, exposure time and level signal duration should be the same, and Exposure Auto and Exposure Time are invalid.
- When the device's Trigger Mode is On, Trigger Source is Line 0 or Line 2, and Trigger Activation is Level High or Level Low, Trigger Width can be selected as Exposure Mode and the device's exposure time is controlled by the signal duration.

The device supports 2 types of exposure time modes, including Ultrashort mode and Standard mode.

Standard Mode

In standard mode, the device supports 3 types of exposure mode, including Off, Once and Continuous. Click Acquisition Control → Exposure Auto, and select Exposure Auto according to actual demands.

Exposure Method	Parameter	Principle
Off	Acquisition Control > Exposure Auto	The camera exposures according to the value configured by user in Exposure Time.
Once		Adjust the exposure time automatically according to the image brightness. After adjusting, it will switch to Off Mode.
Continuous		Adjust the exposure time continuously according to the image brightness.

When the exposure mode is set as Once or Continuous, the exposure time should be within the range of Auto Exposure Time Lower Limit (μs) and Auto Exposure Time Upper Limit (μs).

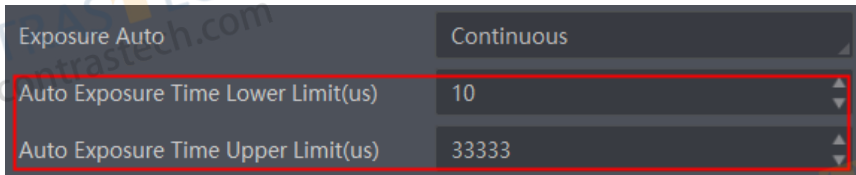

i If the device is under Continuous exposure mode, once external trigger mode is enabled, the device will automatically switch to Off exposure mode.

Ultrashort Mode

In ultrashort mode, the device takes very little exposure time, and the exposure time can only be adjusted manually. Because the exposure time is small, it needs to be used with the light source.

Go to Acquisition Control → Exposure Time Mode, and set Exposure Time Mode according to actual demands.

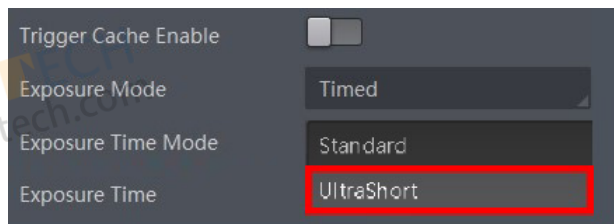

i

- The exposure time mode may differ by device models.
- If the device you got does not support Ultrashort exposure time mode, and then there is no Exposure Time Mode parameter, and your device supports Standard exposure time mode only by default.

Decimation

The decimation feature allows you to reduce the number of sensor pixel columns or rows that are transmitted by the camera. This procedure is also known as "subsampling". It reduces the amount of data to be transferred and may increase the camera's frame rate. Click Image Format Control, and set Decimation Horizontal and Decimation Vertical according to actual demands. Decimation Horizontal is the image's width, and Decimation Vertical is the image's height.



i The decimation function may differ by camera models.

Sequencer Control

The device supports sequencer functions, which allow you to configure multiple groups of parameters to acquire images.

■ Sequencer

If the device supports sequencer, you can configure multiple groups of parameters including exposure time and gain.

Steps:

1. Click Sequencer Control, select Off as Sequencer Mode, and On as Sequencer Configuration Mode.
2. Set Sequencer Set Total Number to configure how many groups to join sequencer according to actual demands.
3. Set Sequencer Set Selector to select one group of parameters, and set Sequencer Feature Selector to configure specific parameters.

i

- Up to 8 groups of parameters can be configured.
- You should go to the corresponding parameters to set their detailed parameters.
- Sequencer Feature Enable is enabled by default for configured parameters.

4. (Optional) Click Execute in Sequencer Set Load to load selected parameters in Sequencer Set Selector.
5. (Optional) Click Execute in Sequencer Set Save to save the selected group of parameters.
6. Repeat step 3 to step 5 to configure other group of parameters.
7. Select On as Sequencer Mode to start sequencer after configuration.

i You cannot configure detailed parameters of group of parameters once sequencer is started.

8. (Optional) Click Execute in Sequencer Restart to let the sequencer start from the beginning group.

Gain

The camera has 2 types of gain, including the analog gain and digital gain. The analog gain is applied before the signal from the camera sensor is converted into digital values, while digital gain is applied after the conversion.

When increasing the analog gain, the image noise will increase too, which will influence image quality. If you want to increase image grayscale value, it is recommended to increase the camera's exposure time. If the exposure time reaches its upper limit, and at this point, you can increase analog gain.

■ Analog Gain

The gain function may differ by camera models.

The camera supports 3 types of analog gain modes: Off, Once and Continuous. Click Analog Control, and select Gain Auto according to actual demands. The analog gain mode and principle are shown below.

Gain Mode	Parameter	Principle
Off	Analog Control > Gain Auto	The camera adjusts gain according to the value configured by user in Gain.
Once		The camera adjusts the gain automatically according to the image brightness. After adjusting, it will switch to Off Mode.
Continuous		The camera adjusts the gain continuously according to the image brightness.

When the analog gain is set as Once or Continuous, the gain should be within the range of Auto Gain Lower Limit and Auto Gain Upper Limit.

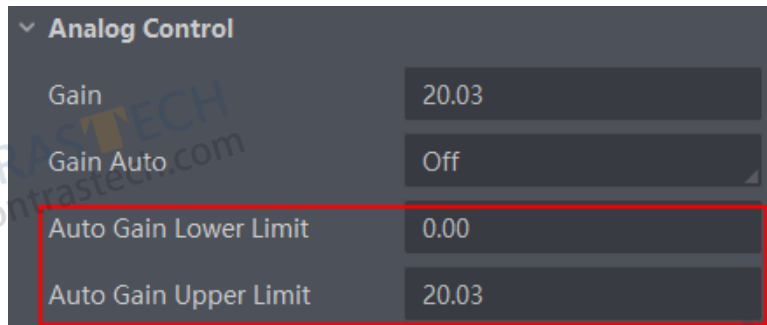

i

- When increasing gain, the image noise will increase too, which will influence image quality. If you want to increase image brightness, it is recommended to increase the device's exposure time first. If the exposure time reaches its upper limit, and at this point, you can increase gain.
- Some models of the device do not support Once or Continuous gain mode. You can enter Gain (dB) directly.

■ Digital Gain

Apart from analog gain, the camera supports digital gain function. When analog gain reaching its upper limit and the image is still too dark, it is recommended to improve image brightness via digital gain.

Click Analog Control, enable Digital Shift Enable, and enter Digital Shift according to actual demands. The range of Digital Shift is from -6 to 6.

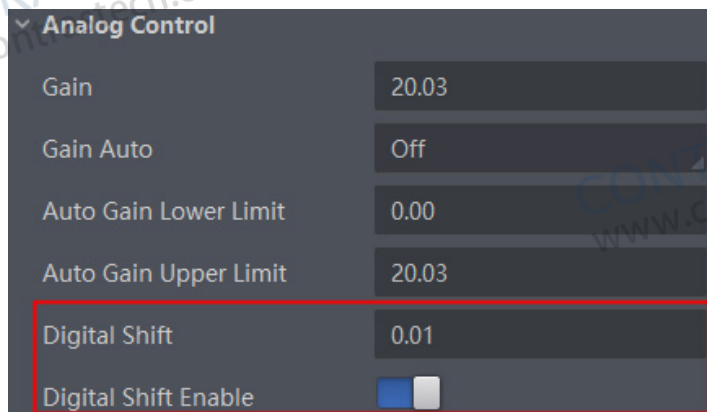

i

When increasing the digital gain, the image noise will greatly increase too, which will severely influence image quality. It is recommended to use analog gain first, and then to adjust digital gain if the analog gain cannot meet demands.

Brightness

The camera brightness refers to the brightness when the camera adjusts image under Once or Continuous exposure mode, or Once or Continuous gain mode. You can set brightness as shown below.

Click Analog Control > Brightness, and set Brightness according to actual demand, and its range is from 0 to 255.

i

- You should enable Once or Continuous exposure mode, or Once or Continuous gain mode first before setting brightness.
- After setting brightness, the camera will automatically adjust exposure time to let image brightness reach target one. Under Once or Continuous exposure mode, or Once or Continuous gain, the higher the brightness value, the brighter the image will be.

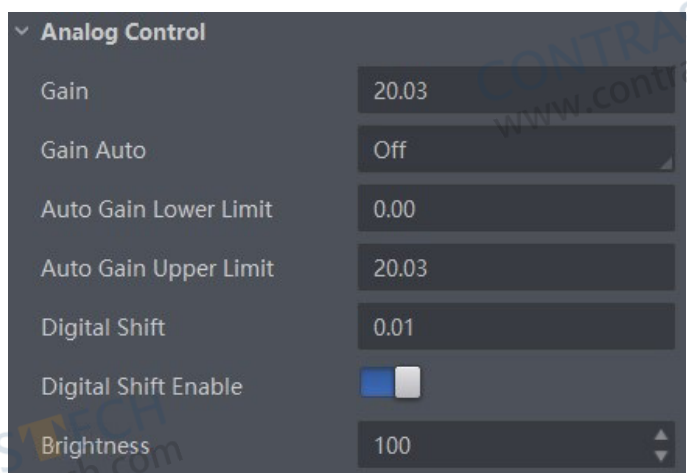

Black Level

The camera supports black level function that allows you to change the overall brightness of an image by changing the gray values of the pixels by a specified amount.

Click Analog Control > Black Level Enable, enable Black Level Enable, and enter Black Level according to actual demands. The range of black level is from 0 to 4095.

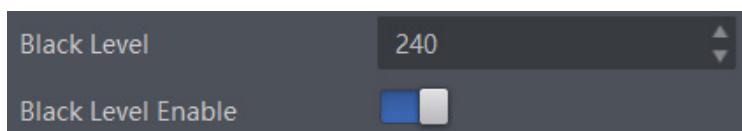

i

The black level function may differ by camera models.

Gamma Correction

The camera supports Gamma correction function. Generally, the output of the camera's sensor is linear with the photons that are illuminated on the photosensitive surface of the sensor. Gamma correction provides a non-linear mapping mechanism as shown below.

- Gamma value between 0.5 and 1: image brightness increases, dark area becomes brighter.
- Gamma value between 1 and 4: image brightness decreases, dark area becomes darker.

i

- The Gamma correction function may differ by device models.
- Regarding the color device in Bayer pixel format, you need to enable Super Bayer Enable first before using Gamma correction function.

Gamma Curve

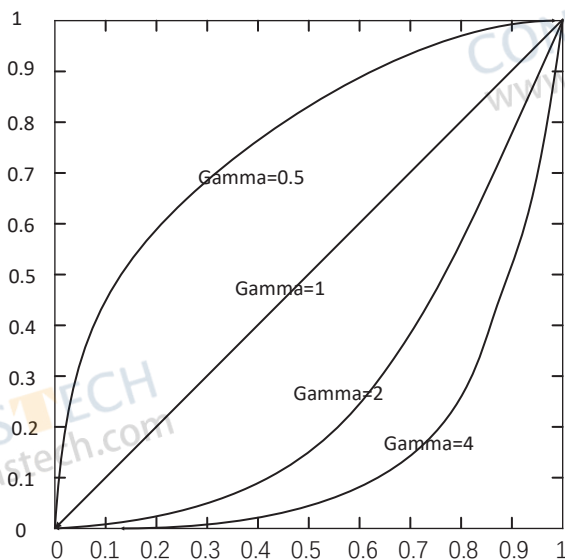

There are 2 types of Gamma correction, including User mode and sRGB mode.

User is a user-defined mode, which can set the value of Gamma; sRGB is a standard protocol mode.

■ User Mode

1. Click Analog Control > Gamma Selector.
2. Select User as Gamma Selector.
3. Enable Gamma Enable.
4. Enter Gamma according to actual demands, and its range is from 0 to 4.

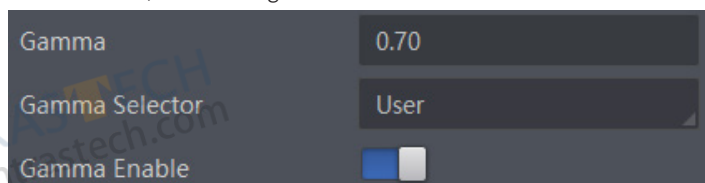

■ sRGB Mode

1. Click Analog Control > Gamma Selector.
2. Select sRGB as Gamma Selector.
3. Enable Gamma Enable.

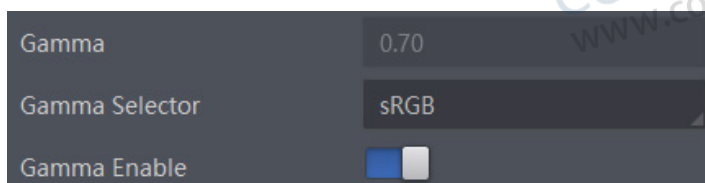

Sharpness

The camera supports sharpness function that can adjust the sharpness level of the image edge, and this function is disabled by default.



- The sharpness function may differ by device models.
- Regarding the color device in Bayer pixel format, you need to enable Super Bayer Enable first before using sharpness function.

Click Analog Control > Sharpness Enable, enable Sharpness Enable, and enter Sharpness according to actual demands. The range of the brightness is from 0 to 100.

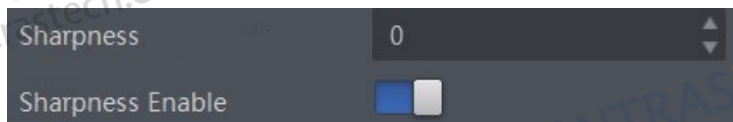

Digital Noise Reduction

The function of digital noise reduction can increase the image's SNR and improve its quality.

Click Analog Control > Digital Noise Reduction Mode, select Expert as Digital Noise Reduction Mode, and enter Denoise Strength and Noise Correct according to actual demands.

The meaning of the parameters is as follows:

- Digital Noise Reduction Mode: Noise reduction mode selection, 2D noise reduction is turned off when OFF is selected; 2D noise reduction is turned on when Expert is selected.
- Denoise Strength: Denoise Strength refers to the intensity of the digital noise reduction, you can increase it to have a better effect.
- Noise Correct: Noise Correct refers to the noise horizontal correction value, and it is used to adjust the noise curve.



- The digital noise reduction function may differ by device models.
- Excessive noise reduction will affect the image details.

Contrast Ratio

The camera supports the contrast ratio function that adjusts the intensity of light and darkness and color. The larger the contrast ratio, and more clear the image is.

Click Analog Control, enable Contrast Ratio Enable, and set Contrast Ratio according to actual demands.

The range of Contrast Ratio is from 0 to 100.



- The contrast ratio function may differ by device models.
- Make sure that the live view is enabled, and Gamma correction and LUT function is disabled before using the contrast ratio function.
- Regarding the color device in Bayer pixel format, you need to enable Super Bayer Enable first before using contrast ratio function.

AOI

The camera supports AOI function that can adjust the brightness and white balance of the entire image based on the area you selected.

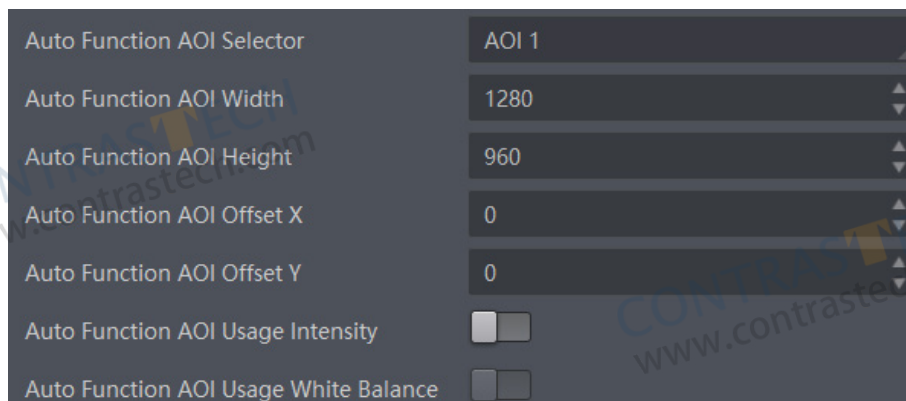

The AOI function may differ by device models.

Steps:

1. Click Analog Control > Auto Function AOI Selector, and select AOI 1 or AOI 2 Auto Function AOI Selector.
2. Enter Auto Function AOI Width, Auto Function AOI Height, Auto Function AOI Offset X, and Auto Function AOI Offset Y according to actual demands.
3. Enable Auto Function AOI Usage Intensity if AOI 1 is selected as Auto Function AOI Selector.

LUT

A Look-Up Table (LUT) is a customizable grayscale-mapping table. You can stretch, amplify the grayscale range that interests you. The mapping can be linear or customized curve.

	<ul style="list-style-type: none"> ● You cannot use Gamma correction function and LUT function at the same time. ● The parameter of LUT Save may differ by device models. If the device has no LUT Save, the settings you configured will be saved in the device in real time. ● For different models of device, the LUT Index and LUT Value range may differ, please refer to the actual one you got. ● Regarding the color device in Bayer pixel format, you need to enable Super Bayer Enable first before using LUT function.
--	---

Steps:

1. Click LUT Control, and enable LUT Enable.
2. Enter LUT Index according to actual demands, and its range is from 0 to 1023.
3. Enter LUT Value according to actual demands, and its range is from 0 to 4095.

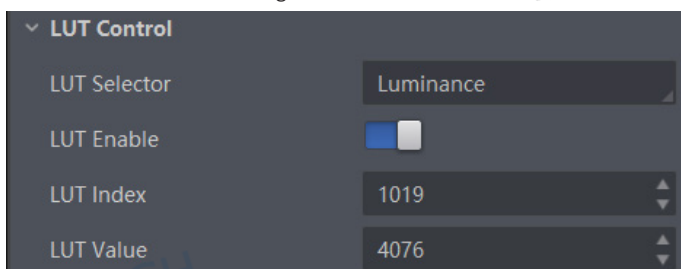

Shading Correction

The camera supports shading correction function that improves the image uniformity when you acquire a non-uniformity image due to external conditions.

	<p>The specific shading correction types that devices support and configuration methods may differ by device models.</p>
--	--

■ LSC Correction (Lens Shading Correction)

LSC correction stands for Lens Shading Correction that eliminates non-uniform illumination brought by lens.

Steps:

1. Click Shading Correction, select LSC Correction as Shading Selector.
2. Click Execute in Activate Shading.
3. Enable LSC Enable.

	<ul style="list-style-type: none"> ● LSC correction should be executed in full resolution. If you are only interested in a certain region of the image, you can set a Region of Interest (ROI) instead. ● Specific steps for executing LSC correction may differ by device models
--	---

CHAPTER 9 OTHER FUNCTIONS

Device Control

In the Device Control attribute, you can view device information, edit device name, reset device, etc. The specific parameters in Device Control attribute are shown below.

Parameter	Read/Write	Description
Device Type	Read only	It is the device type.
Device Scan Type	Read only	It is the scan type of the sensor.
Device Vendor Name	Read only	It is the name of device manufacturer.
Device Model Name	Read only	It is the device model.
Device Manufacturer Info	Read only	It is the manufacturer information.
Device Firmware Version	Read only	It is the device firmware version.
Device Serial Number	Read only	It is the device serial number.
Device User ID	Read and write	Device name and it is empty by default. You can set according to your preference. <ul style="list-style-type: none"> ● If User ID is empty, the client software displays the device model. ● If you set it, the client software displays the User ID you set.
Device Uptime(s)	Read only	It is the period of time when device is powered up.
Board Device Type	Read only	It is the device type.
Device Connection Selector	Read and write	It is the ID of GenICam XML.
Device Connection Speed(Mbps)	Read only	It is the device connection speed.
Device Link Selector	Read and write	It selects device link.
Device Link Speed(Mbps)	Read only	It is the link speed.
Device Link Connection Count	Read only	It is the link connection quantity.
Device Link Heartbeat Mode	Read and write	It enables heartbeat mode or not.
Device Stream Channel Count	Read only	It counts data packet quantity.
Device Stream Channel Selector	Read and write	It is the character set used in register.
Device Stream Channel Type	Read only	It is the stream channel type.
Device Stream Channel Link	Read only	It is the stream channel link quantity.
Device Stream Channel Endianness	Read only	It is the image data endianness.
Device Stream Channel Packet Size(B)	Read and write	It is the data packet size.
Device Event Channel Count	Read only	It is the channel quantity that the device supports.
Device Character Set	Read only	It is the character set used in register.
Device Reset	Read and write	It is the Execute button that resets the device parameters.
Device Temperature Selector	Read and write	It selects device component temperature.
Device Temperature	Read only	It displays the real-time temperature of the device component you selected in Device Temperature Selector.
---	---	---

Device Control

Parameter	Read/Write	Description
Relative Humidity	Read only	It displays the relative humidity inside the camera.
Device Fan Enable	Read and write	It is enabled by the device fan, and it can dissipate heat after turning on.
TEC Enable	Read and write	It is TEC enabled, and when turned on, it can be used for refrigeration control.
TEC Temperature	Read and write	It is the TEC temperature, and the temperature of the target TEC can be set.
TEC Voltage	Read only	TEC voltage
Find Me	Read and write	Click Execute to let red indicator flash once, and find device.
Device Max Throughput(Kbps)	Read only	It is the maximum flow of device operation.
Device PJ Number	Read only	It is the device's project number.

 The specific device control parameters may differ by camera models.

Embedded Information in Image

The device supports embedding information into image data. The information will be embedded into the image according to the enabling condition of each type of information in the order of the image embedding information listed in the table below.

 Width, Height, Offset X, Offset Y and Pixel Format are image embedding information that the device supporting Chunk function has.

Information Type	Byte	Data Format Description
Timestamp	4	4 bytes are used to transfer the timestamp information.
Gain	4	4 bytes are used to transfer the gain information. Each low 8 bits of the 4 valid data are combined to transfer the gain information. Value Range: 0 to 1023. Note: High bits will be complemented with 0 automatically.
Exposure	4	4 bytes are combined to show the exposure time, and the unit is μs .
Brightness Info	4	4 bytes are used to transfer the brightness information. Value Range: 0 to 4095. Note: High bits will be complemented with 0 automatically.
Frame Counter	4	Value Range: 0 to $2^{32}-1$
Ext Trigger Count	4	Value Range: 0 to $2^{32}-1$
Line Input Output	4	4 bytes are used to transfer the line input and output information.
Width	4	Value Range: 0 to $2^{32}-1$
Height	4	Value Range: 0 to $2^{32}-1$
Offset X	4	Value Range: 0 to $2^{32}-1$
Offset Y	4	Value Range: 0 to $2^{32}-1$
Pixel Format	4	Value Range: 0 to $2^{32}-1$
ROI Position	8	The column coordinate occupies 2 bytes, and the row coordinate occupies 2 bytes. The column coordinate information comes first. The length and width occupy 2 bytes respectively, and the length information comes first.

Embedded Information in Image

There are two ways to embed information into the image, including watermark function and Chunk function.





- Watermark function is not available if the device enables image compression mode.
- The Chunk function may differ by device models.
- The device uses Chunk function in priority if it supports both watermark and Chunk function.

Watermark Settings

Steps

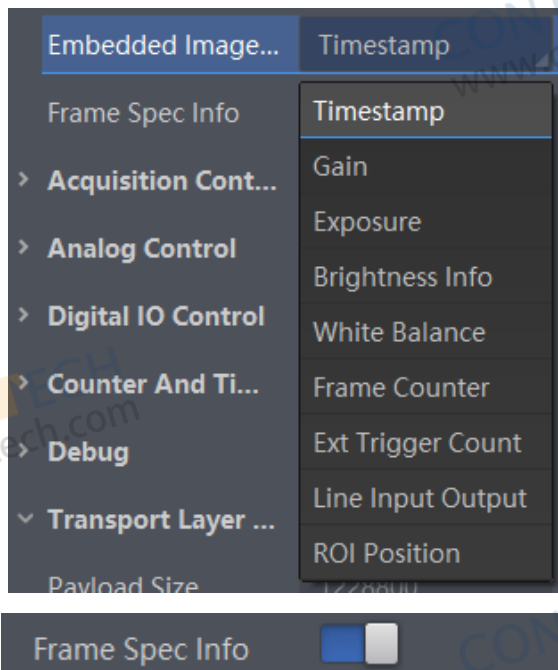
1. Click Image Format Control > Embedded Image Info Selector, and select Embedded Image Info Selector according to actual demands.
2. Enable Frame Spec Info to add watermark into images.



3. (Optional) Repeat steps above to add multiple watermarks.
4. Click  on the control toolbar of the client software to view specific watermark information.



The watermark is embedded into the starting position of the first line of image data. If the ROI is small and the first line of image data is insufficient to embed information, the information will be embedded into the second line of image data.

Chunk Settings

Steps

1. Click Chunk Data Control > Chunk Mode Active, and Chunk Mode Active.
2. Select Chunk Selector according to actual demands.
3. Enable Chunk Enable to embed information into the image.
4. (Optional) Repeat steps above to add multiple Chunk information types.
5. Click  on the control toolbar of the client software to view specific information.

Action Command



- The action command function may differ by device models.
- Only latest version of iDatum support GigE Vision action command.

The action command allows you to execute actions on multiple devices at roughly the same time by using a single broadcast protocol message.

Steps

1. Click Transport Layer Control > GEV IEEE 1588, and enable GEV IEEE 1588.
2. Click Acquisition Control > Trigger Selector, and select Frame Burst Start.
3. Select On as Trigger Mode.
4. Select Line 0 as Trigger Source.
5. Click Tool > GigE Vision Action Command in the menu bar.
6. Select Network Interfaces to set the subnet that the command to be sent to.
7. Enter Device Key, Group Key, and Group Mask.

Parameter Name	Device Parameter Name	Description
Device Key	Action Control > Action Device Key	The parameter value should be the same.
Group Key	Action Control > Action Group Key	The parameter value should be the same.
Group Mask	Action Control > Action Group Mask	The bitwise AND operation of the Group Mask against the Action Group Mask feature should results in non-zero.

8. Enable Scheduled.
9. Click  in Benchmark Camera to select one device as benchmark device. Once benchmark device is selected, other devices keep time synchronization with it.
10. (Optional) Enter Delay Time according to actual demands.



- The delay time should NOT be shorter than the maximum time required to transmit the command across the network.
- When the benchmark device receives the command, all devices will trigger certain actions simultaneously after the specified delay time.

11. (Optional) Enable Periodically Send to enable the client to send commands periodically, and enter Sending Interval according to actual demands.



The default value of sending interval is 1000 ms, and its range is from 1 ms to 3600000 ms.

12. (Optional) Enable Request Acknowledgement to display the acknowledgement messages.
13. Click Start Sending.

File Access Control

The file access function can import or export the device's feature files and save them in mfa format. The supported feature files include User Set 1/2/3, DPC, and LUT Luminance 1/2/3.

Steps:

1. Select a camera in the device list. Click  to open the File Access interface.



2. Select a User Set (User Set 1, User Set 2, or User Set 3) or DPC from the drop-down list.
3. Select Device Feature and click Import or Export.
4. Select a mfa file from local PC to import or select a saving path and enter file name to save and export.



- The file access control function may differ by device model.
- If User Set 1/2/3 is selected as device feature, you need to load the corresponding user set you selected to take effect.
- If LUT Luminance 1/2/3 is selected as device feature, and they will take effect only when you select the same parameters in LUT Selector.
- If DPC is selected as device feature, and it will take effect immediately.
- Importing and exporting the device feature among the same model of devices are supported.

Event Control



The event control function may differ by device model.

The event control can record events happen to the device and allow you to view them.

Steps

1. Click Event Control > Event Selector, and select Event Selector according to actual demands.



The specific events may differ by device models.

2. Select Notification On as Event Notification to output event.
3. Right click the connected device and click Event Monitor.
4. Check Messaging Channel Event, and view the specific event after the device starts live view.

Multicast

The multicast function enables multiple PCs to access the same device at the same time.

At the same time, the same device can only be connected by one client in controller and data receiver mode or controller mode, but can be connected by multiple clients in data receiver mode. The multicast mode of each device within the client is controlled individually. The description of three multicast modes is shown below.

Modes	Description
Controller and Data Receiver	This mode allows you to read and edit the camera's parameters, and get its image data.
Controller	This mode allows you to read and edit the camera's parameters, but you cannot get its image data.
Data Receiver	This mode allows you read the camera's parameters and get its image data, but you cannot edit the camera's parameters.

When the multicast function is enabled, the device icon on the client software of other PCs will become  and you can connect the device via the data receiver mode.

You can set multicast function for both the available device and connected device in the device list, but the specific settings are different.

■ Enable Multicast(Available)

Follow steps below to set multicast function if the device is in available status.

Steps

1. Right click the available device, and click Multicast Settings.
2. Select Role, and enter the IP Address and Port.



- The available status device can use multicast function in Controller and Data Receiver mode or Controller mode.
- The IP address should be class D IP address, and the port ranges from 0 to 65535.

3. Click OK.

■ Enable Multicast(Connected)

Follow steps below to set multicast function if the device is in connected status.

Steps

1. Right click the available device, and click Multicast Settings.
2. Enable the multicast function, and edit the IP Address and Port.



- The connected status device can use multicast function in Controller and Data Receiver mode only.
- The IP address should be class D IP address, and the port ranges from 0 to 65535.

3. Click OK.

Transport Layer Control

You can go to Transport Layer Control attribute to view the camera's load size, GEV version, etc.

Parameter	Read/Write	Description
Paylode Size(B)	Read only	It is the camera's load size.
GEV Version Major	Read only	It is the major version in GEV version.
GEV Version Minor	Read only	It is the minor version in GEV version.
GEV Device Mode Is Big Endian	Read only	It is the endianness in device's register.
GEV Device Mode Character Set	Read only	It is the character set in device's register.
GEV Interface Selector	Read only	It sets which physical network interface to be controlled.
GEV MAC Address	Read only	It is the MAC address of the network interface.
GEV Supported Option Selector	Read and write	It selects the GEV option to interrogate for existing support.
GEV Supported Option	Read only	It indicates whether the selected GEV option is supported or not.
GEV Current IP Configuration LLA	Read only	It indicates whether the Link Local Address IP configuration scheme is activated on the given network interface.
GEV Current IP Configuration DHCP	Read and write	It indicates whether the DHCP IP configuration scheme is activated on the given network interface.
GEV Current IP Configuration Persistent IP	Read and write	It indicates whether persistent IP configuration scheme is activated on the given network interface.
DEV PAUSE Frame Reception	Read and write	It controls whether incoming pause frames are handled on the given logical link.
GEV Current IP Address	Read only	It is the current IP address for the given network interface.
GEV Current Subnet Mask	Read only	It is the current subnet mask of the given interface.
GEV Current Default Gateway	Read only	It is the default gateway IP address to be used on the given network interface.
GEV First URL	Read only	It is the first choice of URL for the XML device description file.
GEV Second URL	Read only	It is the second choice of URL to the XML device description file.
GEV Number Of Interfaces	Read only	It indicates the number of physical network interfaces supported by this device.
GEV Persistent IP Address	Read and write	It indicates the persistent IP address for this network interface. It is only used when the device boots with the persistent IP configuration scheme.
GEV Persistent Subnet Mask	Read and write	It indicates the persistent subnet mask associated with the persistent IP address on this network interface. It is only used when the device boots with the persistent IP configuration scheme.
GEV Persistent Default Gateway	Read and write	It indicates the persistent default gateway for this network interface. It is only used when the device boots with the persistent IP configuration scheme.
GEV Link Speed	Read only	It indicates the speed of transmission negotiated by the given network interface in Mbps.
GEV Message Channel Count	Read only	It indicates the number of message channels supported by this device.
GEV Stream Channel Count	Read only	It indicates the number of stream channels supported by this device.
GEV Heartbeat Timeout(ms)	Read and write	It indicates the current heartbeat timeout in milliseconds.
GEV Heartbeat Disable	Read and write	It disables the GEV Heartbeat.
GEV Timestamp Tick Frequency(Hz)	Read only	It indicates the number of timestamp ticks in 1 second (frequency in Hz).
Timestamp Control Latch	Read and write	It latches the current timestamp value of the device.
Timestamp Control Reset	Read and write	It resets the timestamp value for the device.
Timestamp Control Latch Reset	Read and write	It resets the timestamp control latch.
Timestamp Value	Read only	It is a read only element. It indicates the latched value of the timestamp.
GEV CCP	Read and write	It controls the device access privilege of an application.
GEV Stream Channel Selector	Read only	It selects the stream channel to control.
---	---	---

Transport Layer Control

Parameter	Read/Write	Description
GEV SCP Interface Index	Read only	It is the Index of network interface to be used.
GEV SCP Host Port	Read and write	It is the host port of the channel
GEV SCP Direction	Read only	It transmits or receives the channel.
GEV SCPS Fire Test Packet	Read only	It sends a test packet.
GEV SCPS Do Not Fragment	Read and write	The state of this feature is copied into the "do not fragment" bit of the IP header of each stream packet.
GEV SCPS Big Endian	Read only	It is the Endianness of multi-byte pixel data for this stream.
GEV SCPS Packet Size(B)	Read and write	It specifies the stream packet size (in bytes) to send on this channel.
Auto SCPD	Read and write	After enabling is enabled, the SCPD value can be automatically adjusted to optimize the data transmission process.
GEV SCPD	Read and write	It indicates the delay (in timestamp counter units) to insert between each packet for this stream channel.
GEV SCDA	Read and write	It indicates the destination IP address for this stream channel.
GEV SCSP	Read only	It indicates the source UDP port address for this stream channel.
GEV MCP Host Port	Read and write	It controls the port to which the device must send messages. Setting this value to 0 closes the message channel.
GEV MCDA	Read and write	It controls the destination IP address for the message channel.
GEV MCTT (ms)	Read and write	It provides the transmission timeout value in milliseconds.
GEV MCRC	Read and write	It controls the number of retransmissions allowed when a message channel message times out.
GEV MCSP	Read only	It indicates the source port for the message channel.
Gev IEEE 1588	Read and write	It enables the IEEE 1588 Precision Time Protocol to control the timestamp register.
Gev IEEE 1588 Status	Read only	The status of the IEEE 1588 Precision Time Protocol.
Gev GVSP Extended ID Mode	Read and write	It enables the extended ID mode.

Transfer Control

You can go to the Transfer Control attribute to view the camera's transfer sources, transfer mode, queue information, etc.



The specific parameters of transfer control may differ by device models.

The parameters of user controlled transfer control are shown below.

Parameter	Read/Write	Description
Transfer Control Selector	Read and write	It selects the transfer mode. <ul style="list-style-type: none"> ● Basic: In this mode, the device sends images to the client software directly after acquiring images. ● User Controlled: In this mode, the device saves images in its internal cache first, and then sends to the client software after acquiring images.
Transfer Passive Enable	Read and write	The transfer passive node will be displayed if it is enabled. Note: You should select User Controlled as Transfer Control Selector first.
Transfer Operation Mode	Read and write	It is the transfer operation mode: <ul style="list-style-type: none"> ● Single Block: Click Execute in Transfer Strat to let the device transfer one image each time. ● Multi Block: Click Execute in Transfer Strat to let the device transfer multiple images in cache.
Transfer Queue Max Block Count	Read only	It displays the max. image quantity that the device's memory can save before the compression.
Transfer Queue Current Block Count	Read only	It displays current image quantity saved by the memory.

FullFrame Transmission

Enable the full frame transmission function, you can go to Acquisition Control > FullFrame Transmission to set parameters.

_ When FullFrame Transmission is enabled, if the current transmission frame is stopped, the current frame will be transmitted before responding to the stop.

_ If FullFrame Transmission is not enabled, if the current stream stops during the transmission of the frame, the stop command is immediately responded to and the current frame is discarded.

Save and Load User Set

The camera supports 4 sets of parameters, including 1 default set and 3 user sets.

	After setting user parameters, it is recommended to save user parameters and select them as the default parameters.
--	---

You can save parameters, load parameters and set user default as shown below.

Save Parameters:

1. Click User Set Control, and select a user set in User Set Selector. Here we take selecting User Set 1 as an example.
2. Click Execute in User Set Save to save parameters.

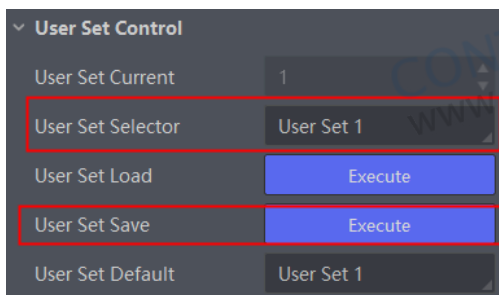

Load Parameters:

1. Click User Set Control, and select a user set in User Set Selector. Here we take selecting User Set 1 as an example.
2. Click Execute in User Set Load to load parameters to the camera, as shown below.

	Loading parameters is available when connecting with camera, but without acquisition.
---	---

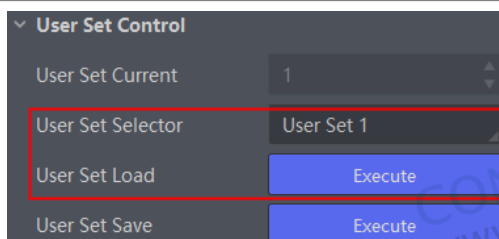

Set User Default:

You can also set default parameter by selecting parameter from drop-down list of User Set Default.

Camera Parameter Index

Attribute	Parameter	Section
Device Control	Device Type	Device Control
	Device Scan Type	
	Device Vendor Name	
	Device Model Name	
	Device Manufacturer Info	
	Device Firmware Version	
	System of Chip Version	
	Device Serial Number	
	Device User ID	
	Device Uptime(s)	
	Board Device Type	
	Device Connection Selector	
	Device Connection Speed(Mbps)	
	Device Link Selector	
	Device Link Speed(Mbps)	
	Device Link Connection Count	
	Device Link Heartbeat Mode	
	Device Stream Channel Count	
	Device Stream Channel Selector	
	Device Stream Channel Type	
	Device Stream Channel Link	
	Device Stream Channel Endianness	
	Device Stream Channel Packet Size(B)	
	Device Event Channel Count	
	Device Character Set	
	Device Temperature Selector	
	Device Temperature	
	Relative Humidity	
	Device Fan Enable	
	TEC Enable	
TEC Temperature		
TEC Voltage		
Find Me		
Device Max Throughput(Kbps)		
Device PJ Number		
Image Format Control	Width Max	Resolution and ROI
	Height Max	
	Region Selector	
	Region Destination	
---	---	---

Camera Parameter Index

Attribute	Parameter	Section
Image Format Control	Width	Resolution and ROI
	Height	
	Offset X	
	Offset Y	
	Reverse X	Image Reverse
	Reverse Y	
	Pixel Format	Pixel Format
	Pixel Size	
	Test Pattern Generator Selector	Test Pattern
	Test Pattern	
	Binning Selector	Binning
	Binning Horizontal	
	Binning Vertical	
	Binning Mode	Decimation
	Decimation Horizontal	
Decimation Vertical		
Acquisition Control	Acquisition Mode	Frame Rate
	Acquisition Start	
	Acquisition Stop	
	Acquisition Burst Frame Count	
	Acquisition Frame Rate(Fps)	
	Acquisition Frame Rate Control Enable	
	Resulting Frame Rate(Fps)	
	Overlap Mode	Overlap Mode
	Trigger Selector	External Trigger Mode
	Trigger Mode	
	Trigger Software	
	Trigger Source	
	Trigger Activation	
	Trigger Delay(μs)	
	Trigger Cache Enable	Exposure
	Exposure Time Mode	
	Exposure Mode	
	Exposure Time (μs)	
	Exposure Auto	
	Auto Exposure Time Lower Limit (μs)	
Auto Exposure Time Upper Limit (μs)	FullFrame Transmission	
FullFrame Transmission		
---	---	---

Camera Parameter Index

Attribute	Parameter	Section
Analog Control	Gain(dB)	Gain
	Gain Auto	
	Auto Gain Lower Limit	
	Auto Gain Upper Limit	
	Digital Shift	
	Digital Shift Enable	
	Brightness	Brightness
	Black Level	Black Level
	Black Level Enable	
	Gamma	Gamma Correction
	Gamma Selector	
	Gamma Enable	
	Sharpness	Sharpness
	Sharpness Enable	
	Digital Noise Reduction Mode	Digital Noise Reduction
	Denoise Strength	
	Noise Correct	
	Contrast Ratio	Contrast Ratio
	Contrast Ratio Enable	
	Auto Function AOI Selector	AOI
Auto Function AOI Width		
Auto Function AOI Height		
Auto Function AOI Offset X		
Auto Function AOI Offset Y		
Auto Function AOI Usage Intensity		
LUT Control	LUT Selector	LUT
	LUT Enable	
	LUT Index	
	LUT Value	
	LUT Save	
Shading Correction	Shading Selector	Shading Correction
	Activate Shading	
	LSC Enable	
Digital IO Control	Line Selector	I/O Output
	Line Mode	
	Line Inverter	
	Line Status	
	Line Status All	
	Line Debouncer Time(μs)	
---	---	---

Camera Parameter Index

Attribute	Parameter	Section
Digital IO Control	Line Source	I/O Output
	Strobe Enable	
	Strobe Line Duration(μs)	
	Strobe Line Delay(μs)	
	Strobe Line Pre Delay(μs)	
Action Control	Action Device Key	Action Command
	Action Queue Size	
	Action Selector	
	Action Group Mask	
	Action Group Key	
Counter And Timer Control	Counter Selector	Counter Trigger
	Counter Event Source	
	Counter Reset Source	
	Counter Reset	
	Counter Value	
	Counter Current Value	
File Access Control	File Selector	File Access Control
	File Operation Selector	
	File Operation Excute	
	File Open Mode	
	File Operation Status	
	File Operation Result	
	File Size(B)	
Sequencer Control	Sequencer Mode	Sequencer Control
	Sequencer Configuration Mode	
	Sequencer Feature Selector	
	Sequencer Feature Enable	
	Sequencer Restart	
	Sequencer Set Total Number	
	Sequencer Set Selector	
	Sequencer Set Active	
	Sequencer Set Load	
	Sequencer Set Save	
Event Control	Event Selector	Event Control
	Event Notification	
Chunk Data Control	Chunk Mode Active	Embedded Information in Image
	Chunk Selector	
	Chunk Enable	
---	---	---

Camera Parameter Index

Attribute	Parameter	Section
Transport Layer Control	Payload Size(B)	Transport Layer Control
	GEV Version Major	
	GEV Version Minor	
	GEV Device Mode Is Big Endian	
	GEV Device Mode Character Set	
	GEV Interface Selector	
	GEV MAC Address	
	GEV Supported Option Selector	
	GEV Supported Option	
	GEV Current IP Configuration LLA	
	GEV Current IP Configuration DHCP	
	GEV Current IP Configuration Persistent IP	
	GEV PAUSE Frame Reception	
	GEV Current IP Address	
	GEV Current Subnet Mask	
	GEV Current Default Gateway	
	GEV First URL	
	GEV Second URL	
	GEV Number Of Interfaces	
	GEV Persistent IP Address	
	GEV Persistent Subnet Mask	
	GEV Persistent Default	
	GEV Link Speed	
	GEV Message Channel Count	
	GEV Stream Channel Count	
	GEV Heartbeat Timeout(ms)	
	GEV Heartbeat Disable	
	GEV Timestamp Tick Frequency(Hz)	
	Timestamp Control Latch	
	Timestamp Control Reset	
	Timestamp Control Latch Reset	
	Timestamp Value	
	GEV CCP	
GEV MCP Host Port		
GEV MCDA		
GEV MCTT(ms)		
GEV MCRC		
GEV MCSP		
GEV Stream Channel Selector		
---	---	---

Camera Parameter Index

Attribute	Parameter	Section
Transport Layer Control	GEV SCP Interface Index	Transport Layer Control
	GEV SCP Host Port	
	GEV SCP Direction	
	GEV SCPS Fire Test Packet	
	GEV SCPS Do Not Fragment	
	GEV SCPS Big Endian	
	GEV SCPS Packet Size(B)	
	GEV SCPD	
	Auto SCPD	
	GEV SCDA	
	GEV SCSP	
	Gev IEEE 1588	
	GEV IEEE 1588 Status	
	Gev GVSP Extended ID Mode	
Transfer Control	Transfer Control Selector	Transfer Control
	Transfer Passive Enable	
	Transfer Operation Mode	
	Transfer Queue Max Block Count	
	Transfer Queue Current Block Count	
User Set Control	User Set Current	Save and Load User Set
	User Set Selector	
	User Set Load	
	User Set Save	
	User Set Default	

 The specific parameter s may differ by camera models.

Trouble Shooting

Trouble:

■ No camera found when running the iDatum

Possible Reason1: Camera is not started up normally

Solution1: Check camera power wiring (observe the indicator)

Possible Reason2: Network cable connection error

Solution2: Check network connection

■ Camera connection error

Possible Reason1: Camera and client software are not in the same network segment

Solution1: Edit its IP address

Possible Reason2: The camera has been connected by another program

Solution2: Reconnect after disconnecting the camera from other programs

■ Live view is black

Possible Reason1: Aperture is closed

Solution1: Open the aperture

Possible Reason2: Camera exception occurs

Solution2: Reboot the camera.

■ Live view is normal, but the camera cannot be triggered.

Possible Reason1: Trigger mode is not enabled

Solution1: Check whether the camera trigger mode and related trigger signal input are normal in the current environment.

Possible Reason2: Incorrect wiring

Solution2: Check whether the wiring is correct under corresponding triggering mode.

■ Why the network changes from GigE Ethernet to Fast Ethernet?

Possible Reason: The network cable may be damaged.

Solution: Check the network cable, and replace it if it is damaged.

CHAPTER 10 TECHNICAL SUPPORT

If you need advice about your camera or if you need assistance troubleshooting a problem with your camera, it's highly recommended to describe your issue in details and contact us via E-mail at support@contrastech.com

It would be helpful if you can fill-in the following table and send to us before you contact our technical support team.

Camera Model:		Camera's SN:	
Describe the issue in as much detail as possible:			
If known, what's the cause of the issue?			
How often did/does the issue occur?			
How severe is the issue?			
Parameter set	Please connect the camera directly to PC and use iDatum to make note of the parameter when the issue occurred.		

Hangzhou Contrastech Co., Ltd

No.8 Xiyuan 9th Road, West Lake District Hangzhou Zhejiang 310030 China
Tel: 86-571-89712238
www.contrastech.com