

LEO Series GigE Line Scan Camera User Manual

V2.5.8, Aug. 2025

Preface

Purpose

This Manual is a basic description of LEO series GigE Line Scan Cameras, which mainly includes the product description, quick installation guide and Simple introduction of SDK(iDatum). This manual may be updated due to product upgrades or other reasons. If you need, please contact the sales engineer for the latest version of this manual.

Copyright ©2024
Hangzhou Contrastech Co., Ltd.
Tel.: +86 571-89712238
Add.:No. 8 Xiyuan 9th Road, West Lake District Hangzhou Zhejiang 310030 China.

All rights reserved. The information contained herein is proprietary and is provided solely for the purpose of allowing customers to operate and/or service Contrastech manufactured equipment and is not to be released, reproduced, or used for any other purpose without written permission of Contrastech.

Disclaimer

The information and specifications described in this manual are subject to change without notice.

Latest Manual Version

For the latest version of this manual, see the Download Center on our web site at: <http://www.contrastech.com/en/service/005001.html>

Technical Support

For technical support, e-mail: support@contrastech.com.

Warranty

To ensure that your warranty remains in force, adhere to the following guidelines:

Do not remove the camera's serial number label

If the label is removed and the serial number can't be read from the camera's registers, the warranty is void.

Prevent ingress or insertion of foreign substances into the camera housing

Prevent liquid, flammable, or metallic substances from entering the camera housing. If operated with any foreign substances inside, the camera may fail or cause a fire.

Avoid electromagnetic fields

Do not operate the camera in the vicinity of strong electromagnetic fields. Avoid electrostatic charging.

Clean with care

Avoid cleaning the sensor if possible.

Handle this camera with care

Do not abuse the camera. Avoid striking, shaking, etc. The camera could be damaged by improper handling.

Read the manual

Read the manual carefully before using the camera.

CHAPTER 1

PRODUCT DESCRIPTION

Product Introduction

LEO series industrial cameras compatible with GigE、USB3.0、10GigE、CameraLink and CoaXPress data bus standards, The GigE line scan camera uses the Ethernet interface to transmit non-compressed images in real time, and it acquires images and sets parameters via the client software or SDK. The GigE line scan camera is applicable to the new energy, consumer electronics, medical material, textiles, railway, material sorting, etc.

Product Features

- Ethernet interface provides 1Gbps bandwidth, with maximum 100m transmission;
- Supports software trigger, hardware trigger, free run mode and etc;
- Supports gamma correction, LUT, black level correction, brightness and other ISP function;
- Supports interpolation algorithm, white balance algorithm, hue, saturation and etc. for color camera;
- Supports various output formats for image data and supports ROI, binning, mirror and etc.;
- Conforms GigE Vision protocol and GenICam standards;

* The camera functions may differ by camera models, please refer to actual functions.

Status LED Description

Status LED	Description
Slow Flashing Red (the interval between on and off is 2000 milliseconds)	The camera wiring exception occurs.
Red light is always on	The camera exception occurs.
Blue light is always off	The camera is in idle status.
Fast Flashing Blue (the interval between on and off is 200 milliseconds)	The camera is acquiring images normally.
Slow Flashing blue (the interval between on and off is 1000 milliseconds)	The camera is acquiring images in trigger mode.
Flashing Alternately Red and Blue	_The firmware is updating. _The function of finding me is executed,

Mechanical Dimensions

The dimensions is in millimeters:

Different models of cameras have different appearances, which are distinguished by resolution.

The Industrial camera contains standard RJ45 GigE interface, 12pin power, I/O input connector and camera working status indicator light.

Use M4 specification locking screw holes to fix the camera.

Camera Housing and Base Mounting Hole Size(mm):

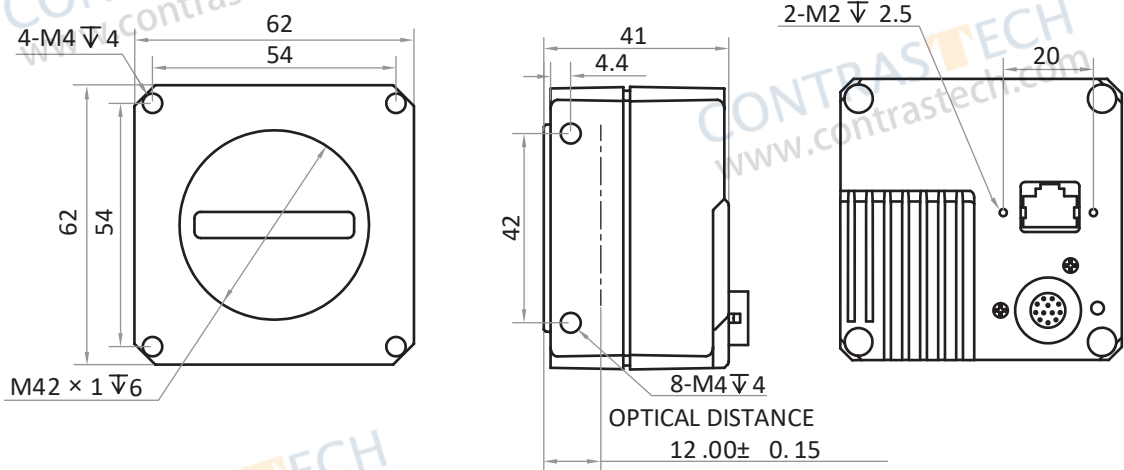

Fig. 1-1: Mechanical Dimensions (in mm) of the 2K/4K GigE Line Scan Cameras with 62*62*41 mm.

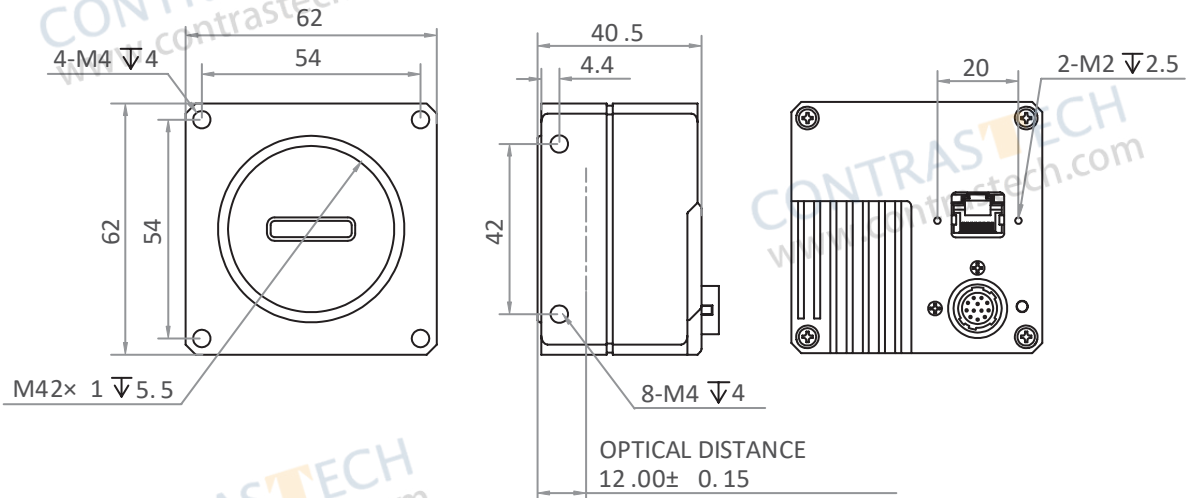

Fig. 1-2: Mechanical Dimensions (in mm) of the 2K GigE Line Scan Cameras with 62*62*40.5 mm.

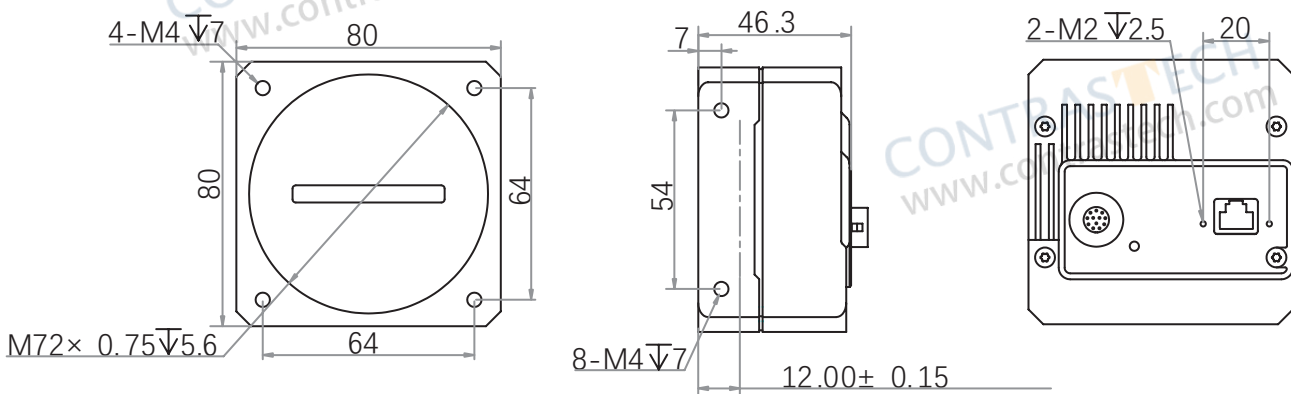

Fig. 1-3: Mechanical Dimensions (in mm) of the 8K GigE Line Scan Cameras with 80*80*46.3 mm.

Mechanical Dimensions

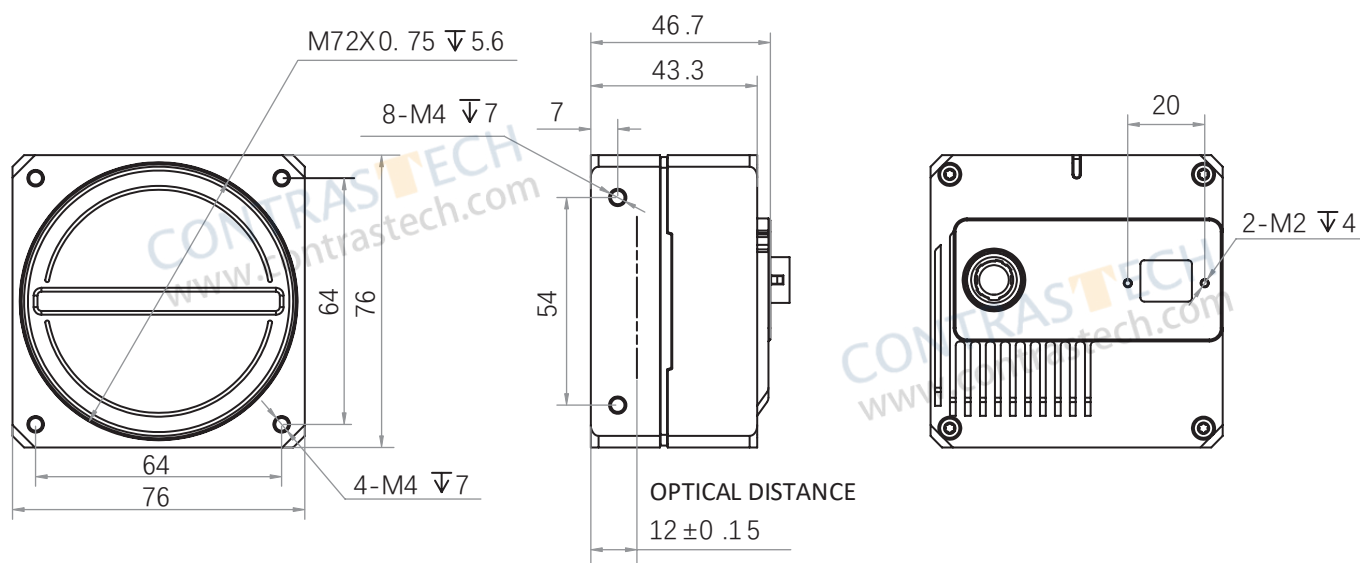

Fig. 1-4: Mechanical Dimensions (in mm) of the 8K GigE Line Scan Cameras with 76*76*46.7 mm.

Fig.No	Camera Model
Fig.1-1	LEO2 2048G-L56gm; LEO2 2048G-L19gc; LEO2 4096G-L28gm; LEO2 4096G-L19gc; LEO 4096G-L28gm/pc-V2; LEO 4096G-L28gm/gc-V3
Fig.1-2	LEO2 2048G-L58gm/gc
Fig.1-3	LEO 8192G-L14gm/gc
Fig.1-4	LEO 8192G-L14gm/gc-V2

CHAPTER 2 POWER AND I/O INTERFACE DEFINITION

I/O Connection Definition and Assignments

The device has a 12-pin P10 connector serving as the power and I/O connector that provides power supply, I/O, and serial port function.

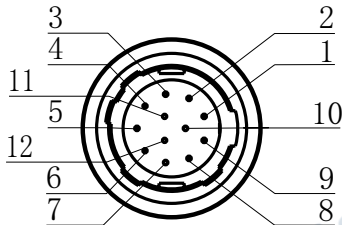

Table 2-1:
Numbering and assignments for
12Pin Connector:

Pin	Signal	Signal Source	Designation
1	GND	-	Power supply ground
2	DC-PWR	-	DC Power +
3	LINE0_P	Line0 +	Differential input/output IO 0+
4	LINE0_N	Line0 -	Differential input/output IO 0-
5	GND	-	Power supply ground
6	LINE3_P	Line3 +	Differential input/output IO 3+
7	LINE3_N	Line3 -	Differential input/output IO 3-
8	LINE4_P	Line4 +	Differential input/output IO 4+
9	LINE1_P	Line1 +	Differential input/output IO 1+
10	LINE1_N	Line1 -	Differential input/output IO 1-
11	DC-PWR	-	DC Power +
12	LINE4_N	Line4 -	Differential input/output IO 4-

The I/O definitions in this manual apply only to ContrasteCH standard cables for LEO cameras. Connect according to the I/O types and pinout. Using cables with different color codes from other manufacturers may cause incorrect connections and damage the camera. Always use ContrasteCH standard cables.

CHAPTER 3 INSTALLATION AND SETUP

You should perform the software installation procedure first and the hardware installation procedure second.

Software Installation

■ iDatum Installation

If you use a firewall on your computer, disable the firewall for the network adapter to which your camera is connected.

Close the Firewall

In order to ensure the camera software keep running and image transmission stability, please close the firewall before using the software.

System Requirements

LEO Camera Software Suite for Windows requirements that one of the following operating systems is installed on your computer:

- Windows XP (32 bit)
- Windows 7 (32 bit or 64 bit)
- Windows 10 (32 bit or 64 bit)
- Linux 32 Bit/64 Bit : Ubuntu 14.04(32/64)、Ubuntu 16.04(32/64)、Redhat7(64)、Centos7(32/64)、gcc/g++ version requires 4.6.3 and above
- ARM: NVIDIA TX2、RaspberryPiB3.0+

Installation Steps

- 1.You can download the iDatum software (LEO Series Industrial Cameras SDK For xxx) from:
<http://www.contrastech.com/en/service/005001.html>
- 2.Double click iDatum installation package to install the client.
- 3.Follow the instructions on the screen. The installer will guide you through the installation process.

Environment Testing

After successful installation, please connect the camera and turn on iDatum client software to check the result of camera connection and image preview. You can start secondary development base on the SDK when all environment testing is normal.

You should notice follow items when using GigE Camera:

- FrameRate Whether the frame rate is consistent with the actual set frame rate.
- Errors If not 0, it means there is a frame skip, it is abnormal.
- Lost Packets If not 0, it is abnormal.

Hardware Installation

■ Camera Installation

The installation procedures assume that you will be making a peer-to-peer connection between your camera and a computer.

Make sure that the following items are available before starting the installation:

- LEO GigE Line Scan Camera
- Applicable power supply or a Gigabit Ethernet Switch
- It refers to the lens that matches with lens mount of the camera.
- The computer with a GigE network adapter installed
- The computer must be equipped with appropriate operating system
- The cameras use standard Ethernet cable (CAT5 above or CAT6).

Steps:

- Mount lens that matches with lens mount of the camera
- Connect the camera to the computer and power PoE:
 - For the camera that supports PoE, use a network cable to connect the camera to a switch that supports PoE or a network interface card.
- Direct supply:
 - Use the 12-pin power and I/O cable to connect the camera to a power adapter.

Network Settings

Before using the camera, you need to configure IP is in the same network segment with the computer. You can modify it in "Local Connection" to ensure network communication is normal.

Local Network Configuration :

- Click "Control Panel"> "Network and Internet"> "Network and Sharing Center"> "Change Adapter Configuration." Then select corresponding network card to configure it automatically obtain IP address or manually assign it as same network segment address with the camera. Shown as below:
- Open "Advanced" in the properties, set "Jumbo Frame" as its maximum value:9014bytes, both of transmit buffer and receive buffer set as 2048bytes, the Interrupt Throttle Rate set as extremum value. These maximum values mentioned above depend on the specific network card. Shown as below:

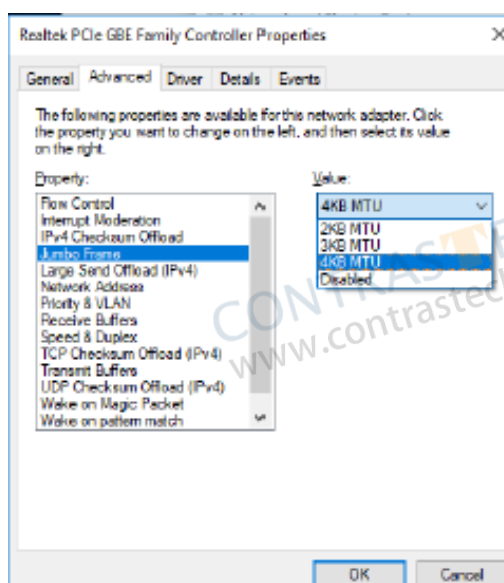

Software Operation

■ iDatum Operation

1. Double-click the iDatum shortcut on the desktop to open up the client software.
2. Click in device list  to search the device.
3. Select a device to be connected.
4. Right click the device, and click Modify IP.
5. Set the IP address of the device in the same network segment with the PC
6. Click OK.

Click ">" in the camera's feature panel to unfold the specific camera parameters, and set them according to actual demands. Please see the table below for the introduction of each attribute classification.

Attribute	Description
<i>Device Control</i>	You can view the device information, edit its name, reset the device, etc.
<i>Image Format Control</i>	You can view and set the device's resolution, image reverse function, pixel format, region of interest, test pattern, etc.
<i>Acquisition Control</i>	You can view and set the device's acquisition mode, frame rate, trigger mode, exposure time, etc.
<i>Analog Control</i>	You can view and set the device's gain, black level, Gamma correction, sharpness, etc.
<i>Color Transformation Control</i>	You can view and set the device's color transformation related parameters like hue and saturation.
<i>LUT Control</i>	You can view the Look-Up Table (LUT), and set its index and value.
<i>Encoder Control</i>	You can set encoder control to convert source signal of external trigger into internal signal.
<i>Frequency Converter Control</i>	You can set frequency converter control to convert external signal of different frequencies into internal signal.
<i>Shading Correction</i>	You can set shading correction to correct shade.
<i>Digital IO Control</i>	You can set the different input and output signals.
<i>Action Control</i>	You can view and set the device's action control related parameters.
<i>Counter And Timer Control</i>	You can view and set the counter related parameters.
<i>File Access Control</i>	You can view and set the device's file access control related parameters.
<i>Event Control</i>	You can view and set the device's event control related parameters to let the device generate an event and transmit a related event message to the computer.
<i>Chunk Data Control</i>	You can view and set the device's chunk data control related parameters to generate supplementary image data and append that data to every image that you acquire.
<i>Transport Layer Control</i>	You can view and set the parameters of the device's transport layer.
<i>Transfer Control</i>	You can view the device's transfer sources, transfer mode, queue information, etc.
<i>User Set Control</i>	You can save or load the device's parameters.



The camera's attribute tree and parameters may differ by camera models.

Software Operation

■ Main interface

For specific main window of the client software, please refer to the actual one you got.

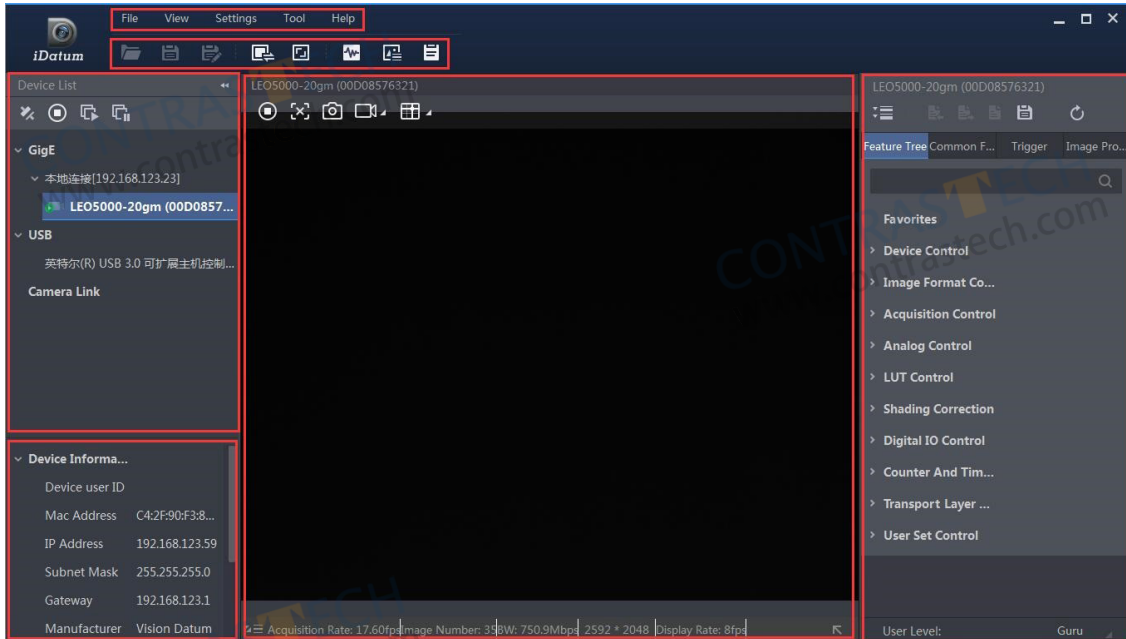

■ Menu Bar

The menu bar for iDatum client provides following functions: File, View, Settings, Tool and Help, as shown in the figure below.

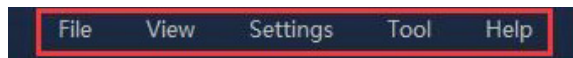

■ Control Toolbar

The control toolbar provides quick operations for the device. the icon meaning is shown in the figure below. The operation buttons in the tool bar can quickly and conveniently edit camera images.

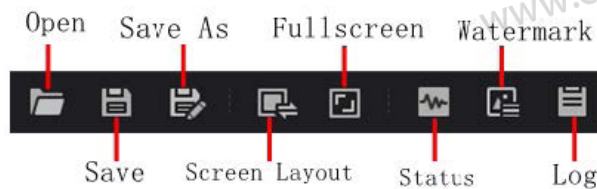

The meaning of shortcut icons in Device List is shown as below.



- Connection/Disconnection: After you selecting the camera, click "Connect" to connect the camera; click "Disconnect" to disconnect the camera.
- Start/Stop Acquisition: For current connected camera, click "Start Acquisition" to acquire image data; click "Stop Acquisition" to stop image data acquisition.
- Batch Start Acquisition: click "Batch Start Acquisition" to start image data acquisition for all currently connected camera by iDatum.
- Batch Stop Acquisition: click "Batch Stop Acquisition" to stop image data acquisition for all currently connected camera by iDatum.
- Expansion/Collapse: This function can be used to expand or collapse the Device List and Device Information which list on the left side of iDatum, and the default state is expansion. In the "Collapse" state, the iDatum left side only display the searched cameras.

CHAPTER 4 IMAGE ACQUISITION

Line Rate

Line rate refers to the image line number that is output by the camera per second. The frame rate of the camera is proportional to the line rate, and is inversely proportional to the height of the image area, that is, $Fps=Lps \text{ (line rate)}/\text{Height (image height)}$.

The following 5 factors determines the camera's frame rate in real-time.

- Readout time: The less the readout time and the higher the line rate will be.
- Exposure time: The less the exposure time, the higher the line rate will be.
- Bandwidth: The larger the bandwidth, the higher the line rate will be.
- Pixel format: The more bytes pixel format occupy, the lower the line rate will be.
- Image compression mode: This function is used to compress data before transmitting to the PC, and increase the line rate to some extent.



For different models of camera, the Image compression mode may be different, please refer to the actual one you got.

The camera can also manually control the real-time line rate.

The specific steps are as follows:

Click Acquisition Control > Acquisition Line Rate (Hz), enter Acquisition Line Rate (Hz) according to actual demands, and enable Acquisition Line Rate (Hz) Control Enable.

_If the current real-time line rate is smaller than configured line rate, the camera acquires images according to the real-time line rate.

_If the current real-time line rate is larger than configured line rate, the camera acquires images according to the configured line rate.

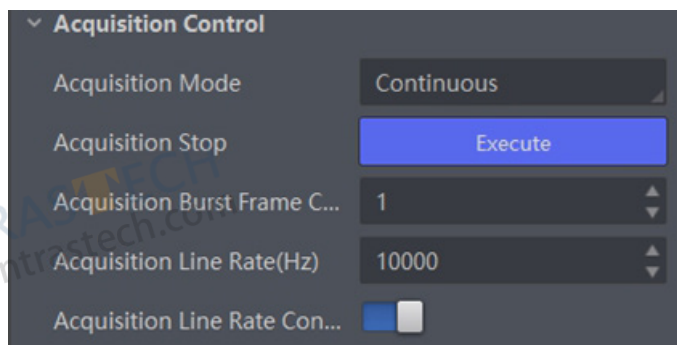

3. When you enable the image compression mode (see section Set Image Compression Mode for details), you can view Reference Line Rate (Hz) that stands for the min. line rate that is calculated according to compression ratio.

4. You can refer to Resulting Frame Rate to view the camera's resulting frame rate.



- For different models of camera, the image compression mode function may differ, and the actual product you purchased shall prevail.
- After enabling the image compression mode, the camera's line rate and frame rate are related with exposure and camera sensor only.

Adjust Line Rate

Image compression and image stretching may occur when the captured line rate does not match with the moving speed of the target object.

- Normal: Captured line rate = moving speed of the target object
- Image stretching: Captured line rate > moving speed of the target object
- Image compression: Captured line rate < moving speed of the target object

You can adjust the pixel ratio in both the length and width directions of a circular or square object to 1:1. Image compression or image stretching can be adjusted by increasing and decreasing the line rate, respectively.

The method of adjusting the line rate varies depending on the moving speed of the target object.

- When the target object is moving at a uniform speed, set the Acquisition Line Rate(Hz) to the line rate calculated from the object's moving speed.

The calculation formula of line rate is shown below.

$$\text{Hz (Line Rate)} = \text{pixel} \times V / L$$

The Pixel is the lateral resolution of the camera, V is the moving speed of the target object, and L is the lateral length of the object.

- When the target object is moving at a non-uniform speed, you can change to line trigger mode, and adjust the line rate by setting the pre-divider, multiplier and post-divider. Refer to section Set Trigger Mode and section Set and Execute Frequency Converter Control.

Frame Timeout

The device supports frame timeout function that affects the device's acquisition and image output mechanism.

Go to Acquisition Control, enable Frame Timeout Enable, and select Partial Image Output Mode according to actual demands.

Parameter	Description
Image Pending	After the number of lines output by the device reaches the configured image height (height parameter), one frame of the image will be outputted. If the number of output lines does not reach the image height (height parameter), the SDK will not output the image, and the SDK will wait for the line data until it reaches the image height before outputting the image.
Partial Image Output	When the number of lines output by the device reaches the configured image height (height parameter) within the frame timeout period, and one frame of image will be output. If the number of lines output by the device does not reach the configured image height (height parameter) within the frame timeout period, the SDK will output the image according to the actual height.
Partial Image Discard	When the number of lines output by the device reaches the configured image height (height parameter) within the frame timeout period, and one frame of image will be output. If the number of lines output by the device does not reach the configured image height (height parameter) within the frame timeout period, the SDK discards the image.
Partial Image Filled	When the number of lines output by the device reaches the configured image height (height parameter) within the frame timeout period, and one frame of image will be output. If the number of lines output by the device does not reach the configured image height (height parameter) within the frame timeout period, SDK will output the image after filling the black according to the height parameter for the remaining part.



- If Frame Timeout Enable is enabled, you can select PartialImageOutput, PartialImageDiscard, and PartialImageFilled.
- If Frame Timeout Enable is not enabled, the image output is related with configured trigger mode.
 - When the FrameTrigger Mode and LineTrigger Mode are Off, or when LineTrigger Mode is On, only Image Pending is supported.
 - When the FrameTrigger Mode and LineTrigger Mode are On, and FrameTrigger Activation and LineTrigger Activation are Level High or Level Low, or when FrameTrigger Mode is On, and FrameTrigger Activation is Level High or Level Low, all image output modes are supported, and the device outputs last frame of image in accordance with configured image output mode.
- The Frame Trigger Control can be set only if the Frame Scan is selected as Scan Mode.

Scan Direction

The scan direction function is used to change the scan direction of the sensor used on measured objects. The figures below are the actual effects.

Image when Direction Matched of Mono Device

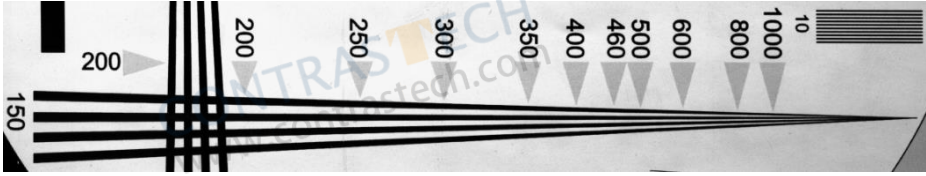

Image when Direction Mismatched of Mono Device

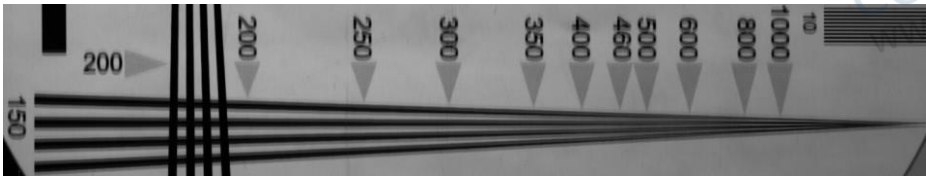

Image when Direction Matched of Color Device

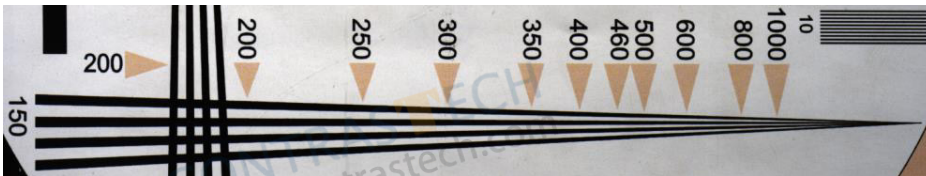
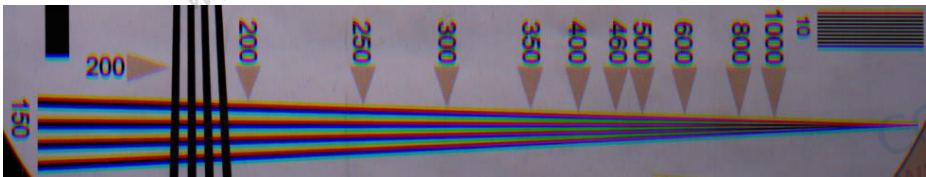

Image when Direction Mismatched of Color Device



Regarding 3 TDI device, after selecting 2-TDI or 3-TDI as TDI Mode, follow steps below to set scan direction.

Steps

1. Go to Image Format Control → Direction Source.
2. Set Direction Source according to actual demand.
3. (Optional) Select Internal as Direction Source and enable Reverse Scan Direction if you want to use the internal signal to achieve reverse scan function.
4. (Optional) Select Line 3 Level as Direction Source and the device will switch to forward scan direction if Line 3 is in high level. Otherwise, the device will switch to backward scan direction.
5. (Optional) Select Line 3 Edge as Direction Source and the device will switch scan direction if Line 3 is in rising edge.

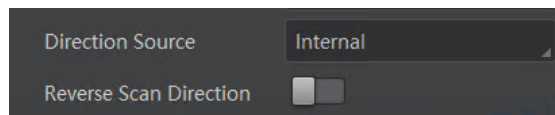

Regarding other types of the device, go to Image Format Control → Reverse Scan Direction to enable Reverse Scan Direction according to actual demands, and observe the image effect at the same time.

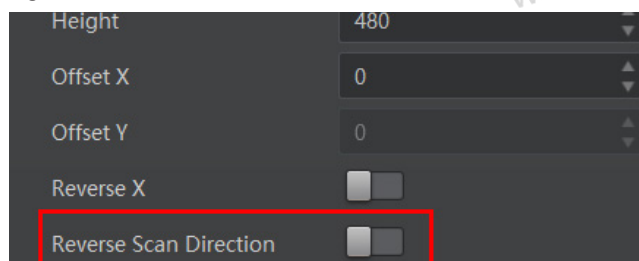

The specific method of setting scan direction may differ by device models.

Abnormal Line Function

Due to the inherent functional features of the sensor or the device itself, the first few lines of image acquisition may have abnormal images and need to be discarded. The device provides line discard function, which can adjust and control the number of external line trigger signals to ensure that the image acquisition meets the usage requirements.

You can go to Acquisition Control, and enable Abnormal Line Enable according to actual demands.

- When this function is enabled, the external device needs to send N more trigger signals to meet the line height of image acquisition, and the first N lines of abnormal images are discarded.
- When this function is not enabled, the quantity of external trigger signal is equal to that of the device's line height, and any abnormal lines that may exist are not discarded.



The line discard function may differ by device models.

Acquisition Mode

The device supports two types of acquisition modes, including SingleFrame mode and Continuous mode. Go to Acquisition Control → Acquisition Mode, and select Continuous or SingleFrame as Acquisition Mode according to actual demands.

Parameter	Parameter Value	Principle
Acquisition Control > Acquisition Mode	SingleFrame	When device starts image acquisition, it acquires one image only, and then stops.
	Continuous	When device starts image acquisition, it acquires images continuously. Real-time frame rate decides the acquisition frame number per second. You can stop image acquisition manually.

Trigger Mode

The device has 4 types of trigger modes, including internal trigger mode, line trigger mode, frame trigger mode, and line + frame trigger mode. The trigger mode is controlled by Trigger Selector and Trigger Mode in Acquisition Control.

Trigger Mode	Parameter	Parameter Value	Principle
Internal trigger mode	Line Start	Off	The device acquires images per lines via its internal signal and outputs images per frames according to configured parameters.
	Frame Burst Start	Off	
Line Trigger	Line Start	On	The device acquires images per lines via the external signal and outputs images per frames according to configured parameters.
	Frame Burst Start	Off	
Frame Trigger	Line Start	Off	The device acquires images after receiving the external signal, and acquires images per lines Frame Burst Start On via its internal signal.
	Frame Burst Start	On	
Line + Frame Trigger	Line Start	On	The device acquires images after receiving the external signal, and acquires images per lines via another external signal.
	Frame Burst Start	On	

External Trigger Source

	<ul style="list-style-type: none"> ● The trigger sources in the tables below are valid for frame trigger mode, line trigger mode, or line + frame trigger mode. ● In line + frame trigger mode, when the trigger source selected by the frame trigger and the line trigger and the trigger-related parameters are the same, the first signal of trigger source will be used as the frame trigger signal to make the device start to acquire images, and the subsequent signals as line trigger signal to acquire images per lines until the processing of one frame of image is completed, and then the processing of the next frame of image is performed.
--	---

The device's trigger source includes software trigger, hardware trigger, shaft encoder control, frequency converter control, action command trigger, and anyway mode. Refer to the tables below to see the trigger source under frame trigger mode or in line trigger mode.

External trigger mode	Parameter Value	Principle
Software Trigger	Software	The software sends trigger signal to the camera via GigE interface to acquire images. Note: The software trigger is available only when frame trigger is enabled.
Hardware Trigger	Line *	External device connects camera via camera I/O interface. External device sends trigger signal to camera to acquire images.
Shaft encoder control	Encoder Module Out	This trigger source uses shaft encoder module to receive signal A and signal B with phase difference. After internal computing of the module, the outputted signal can be used as camera's trigger signal. Note: The shaft encoder control is available only when line trigger is enabled.
Frequency converter control	Frequency Converter	This trigger source allows different frequency between trigger camera signal and required input signal.
Action Command Trigger	Action 1	This trigger source is applied in PTP function. Refer to section Set Action Command for details.
Free Trigger	Anyway	The device can receive software trigger, hardware trigger, frequency converter control, or action command trigger to acquire images.

Trigger Mode

■ Software Trigger

In software trigger, the software sends trigger signal to the device via GigE interface to acquire images.

1. Go to Acquisition Control → Trigger Selector, and select Frame Burst Start as Trigger Selector.
2. Select On as Trigger Mode.
3. Select Software as Trigger Source.
4. Click Execute in Trigger Software.

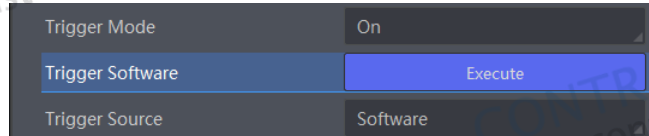

■ Hardware Trigger

The hardware trigger is valid when the frame trigger or line trigger is enabled. In hardware trigger, external device sends trigger signal to the device to acquire images via I/O connector.

Steps

1. Go to Acquisition and Transfer Control → Scan Mode, and select Frame Scan or Line Scan.
2. Enable FrameTrigger Mode in Frame Trigger Control or LineTrigger Mode in Line Trigger Control.
3. Select Line * as FrameTrigger Source or LineTrigger Source according to actual demands.

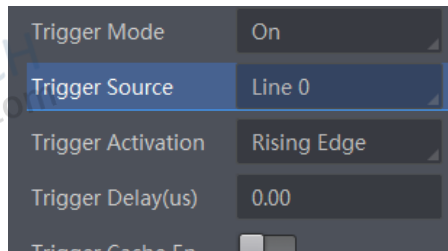

- The Frame Trigger Control can be set only if the Frame Scan is selected as Scan Mode.
- Refer to section Set Trigger Related Parameters for parameters that can be configured in the trigger source, including acquisition burst frame count, trigger activation, trigger delay, trigger debouncer, and trigger cache.

When selecting bi-directional configurable line as the hardware trigger source, you need to make sure that its line mode is input. Go to I/O Control, select specific line as Line Selector, and Input as Line Mode.



Here we take Line 1 as an example to introduce how to set bi-directional configurable line as the hardware trigger source. Refer to the device you got for the actual condition.

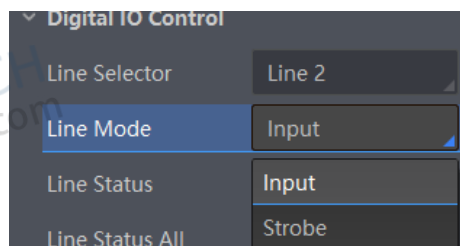

You can also set the signal type for the selected bi-directional configurable line. Go to Digital IO Control, and set Line Format according to actual demands.

- SingleEnded: It can receive single-ended input signal.
- Differential: It can receive TTL & LVTTTL standard input signal.



You need to select line format according to the external device connected. Otherwise, I/O may be damaged.

Trigger Mode

■ Shaft Encoder Control

If the device enables the line trigger, you can select shaft encoder control as trigger source.

At this time, the device will receive signal A and signal B with phase difference. The function demonstration of shaft encoder module is shown below.

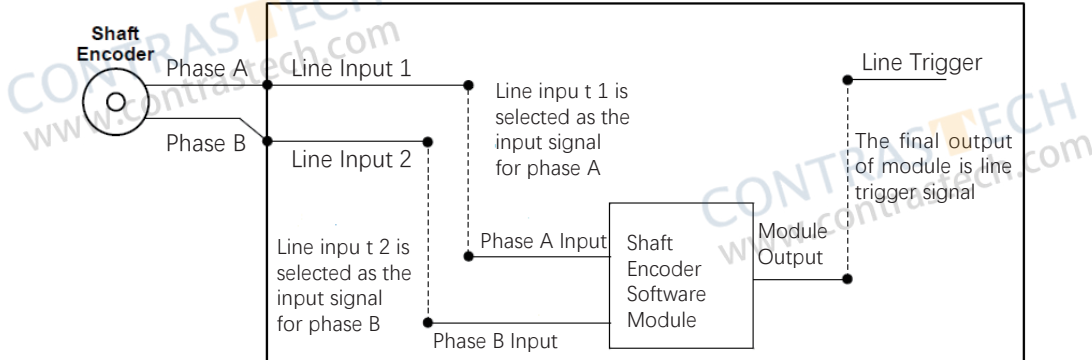

The advantages of shaft encoder are as follows:

- Encoder output pulse frequency is proportional to rotating speed.
- The output pulse acts as a trigger signal for line scan camera.
- Synchronize acquisition speed and sample movement of camera.
- Non-uniform motion can also be a perfect match.
- A trigger signal can be set as acquiring multiple lines or multiple frames with adjustable ratio.

Follow steps below to set shaft encoder control:

1. Click Encoder Control, and set Encoder Source A and Encoder Source B according to actual demands.

It is recommended to choose different signal sources for A and B. If the same trigger source is selected, the shaft encoder will not output a signal.

2. Set the trigger direction of the source signal via Encoder Trigger Mode parameter. Any Direction, Forward Only and Backward Only can be selected.

- Any Direction: means that both forward and backward direction will trigger.
- Forward Only: mean that only forward direction will trigger.
- Backward Only: mean that only backward direction will trigger.

The process Logic may differ by device models:

_ The 2K device outputs one signal in one source signal.

_ The 4K and 8K devices output four signal in one source signal.

Process Logic of 1 Tick

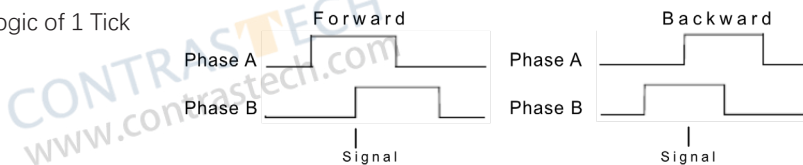

Process Logic of 2 Ticks

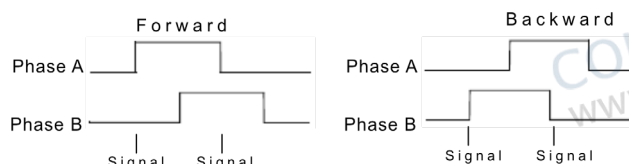

Process Logic of 4 Ticks

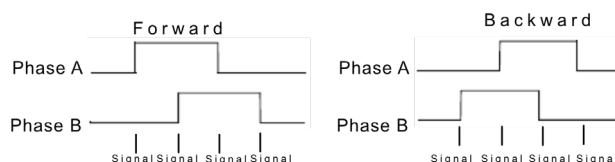

Trigger Mode

3. Set Encoder Counter Mode.

- Ignore Direction means that both forward and backward direction will count.
- Follow Direction means that the forward direction is valid, and Encode Counter will increase.
- Backward Direction means that the backward direction is valid, and Encode Counter will increase.

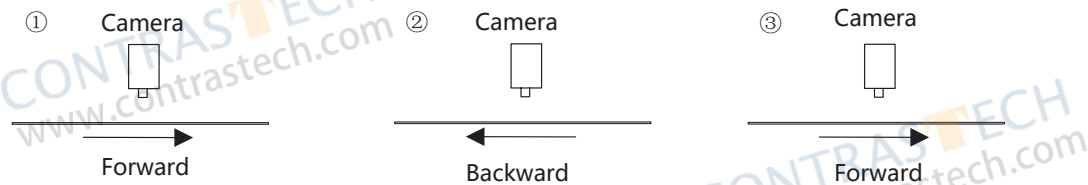

4. (Optional) Set max. counter value in Encoder Counter Max.



- The range of Encoder Counter Max. may differ by device models.
- After reaching the max. value, it will be cleared automatically or you can clear manually by clicking Encoder Counter Reset.

5. (Optional) Set Encoder Max Reverse Counter to avoid outputting images if the object moves backward accidentally during measurement, and click Execute in Encoder Reverse Counter Reset to let the device to output images again.

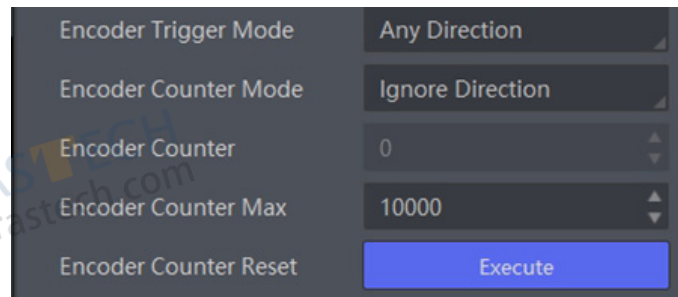

Trigger Mode

■ Frequency Converter Control

If the camera enables the frame trigger or the line trigger, you can select Frequency Converter as trigger source. The hardware signal trigger or shaft encoder control signal can be converted into the signal frequency of frame trigger or line trigger by camera's frequency converter module.

The frequency converter module includes PreDivider, Multiplier and PostDivider. The signal after being processed by these 3 modules is the camera's final trigger signal.

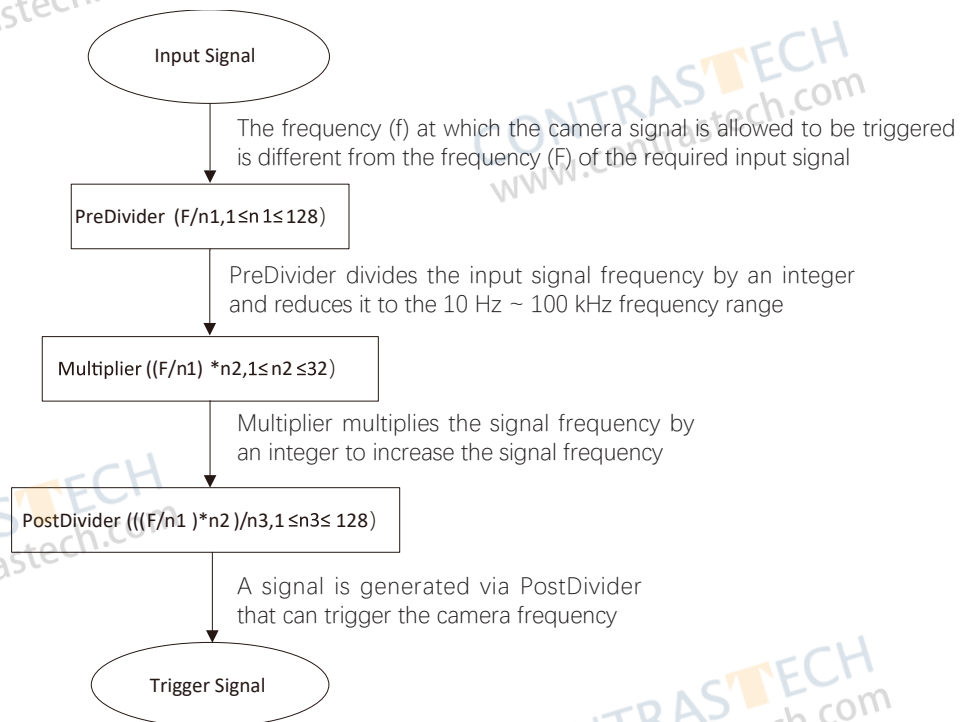

PreDivider

The input signal first enters the PreDivider module, which reduces source signal frequency via integer division, and then the signal is sent to the Multiplier module.

The PreDivider module reduces periodic jitter on the input signal, and signals above 100 kHz must go through the PreDivider module to reduce the frequency for the Multiplier can only receive signals in the range of 10 Hz to 100 kHz frequency range. The periodic jitter of shaft encoder signal is accepted.

Multiplier

After the signal is processed by the PreDivider, it is sent to the Multiplier. The Multiplier multiplies the signal by an integer to increase its signal frequency, and then the signal is sent to the PostDivider.

Parameter can be set as rising or falling edge. If a rising edge is set, each rising edge of the signal coming from the PreDivider will be locked to match the signal of the rising edge, and vice versa.

During this process, make sure do not increase signal frequency via too larger multipliers to avoid trigger signal frequency beyond the max. line rate of the device. Even if a smaller multiplier is selected, an excessively high frequency may be generated in the frequency adjustment, exceeding the max. line rate of the device.

PostDivider

PostDivider reduces signal frequency via an integer factor, and uses the newly generated frequency signal as the device's trigger signal.

Follow steps below to set frequency converter control.

Steps

1. Click Frequency Converter Control, and select specific line, Encoder Module Out or N/A as Input Source according to actual demands.



N/A means that the signal source is not selected.

Trigger Mode

2. Set Rising Edge or Falling Edge as Signal Alignment according to actual demands.
3. Set PreDivider, Multiplier and PostDivider.

The device supports displaying trigger line rate.



- Parameters of trigger line rate and resulting trigger line rate may differ by device models.
- Make sure that line trigger is enabled and input source value of frequency converter control and trigger source value of acquisition control is the same before viewing trigger line rate.
- The trigger line rate is valid when the external trigger source is selected as the Input Source. If N/A is selected, the trigger line rate is 0.
- It is recommended to make sure the frequency of the final trigger signal does not exceed the maximum line frequency of the camera during frequency conversion.

- **Trigger Line Rate:** It refers to the external trigger raw line rate after filtering, and it only involves external trigger signals.
- **Resulting Trigger Line Rate:** It refers to the external trigger frequency devices received after the external trigger raw line rate is calculated via frequency converter control. It only involves external trigger signals.

■ Anyway Mode

When the device enables the frame trigger or the line trigger, you can select anyway mode as trigger source. In this mode, the device can receive all trigger source signals to acquire images.

Steps

1. Go to Acquisition and Transfer Control → Scan Mode, and select Frame Scan or Line Scan.
2. Enable FrameTrigger Mode in Frame Trigger Control or LineTrigger Mode in Line Trigger Control.
3. Select Anyway as FrameTrigger Source or LineTrigger Source.



Refer to section Set Trigger Related Parameters for parameters that can be configured in the trigger source, including acquisition burst frame count, trigger activation, trigger delay, trigger debouncer, and trigger cache.

Trigger Mode

Trigger Related Parameters

If the device enables the frame trigger or line trigger, you can set trigger related parameters, including acquisition burst frame count, trigger activation, trigger delay, trigger cache, and trigger debouncer.



- Different trigger sources and trigger modes can set various parameters.
- Frame trigger cache and line trigger cache may differ by device models.
- √ is supported, and × is not supported.

- If the frame trigger is enabled, the relation between trigger source and trigger related parameters is shown below.

Trigger Parameter	Trigger Source			
	Software Trigger	Hardware Trigger	Frequency Converter Control	Free Trigger
Burst Frame Count	√	√	√	√
Trigger Delay	√	√	√	√
Frame Trigger Cache	√	√	√	√
Trigger Activation	×	√	√	√
Trigger Debouncer	×	√	√	√

- If the line trigger is enabled, the relation between trigger source and trigger related parameters is shown below.

Trigger Parameter	Trigger Source			
	Hardware Trigger	Shaft Encoder Control	Frequency Converter Control	Free Trigger
Trigger Delay	√	√	√	√
Line Trigger Cache	√	√	√	√
Trigger Activation	√	√	√	√
Trigger Debouncer	√	×	×	√

Burst Frame Count

If the device enables the frame trigger, you can set the acquisition burst frame count. Go to Acquisition Control → Acquisition Burst Frame Count, and enter Acquisition Burst Frame Count according to actual demands.

Acquisition Burst Frame Count

1



- The range of Acquisition Burst Frame Count is from 1 to 1023.
- If Acquisition Burst Frame Count is 1, the device is in single frame trigger mode. If Acquisition Burst Frame Count is larger than 1, the device is in multi-frame trigger mode.
- If Acquisition Burst Frame Count is n, when input 1 trigger signal to the device, the device stops acquiring images after exposing n times and outputting n frame images.
- The sequence diagram above uses rising edge as trigger activation, and the device's height parameter is 4.

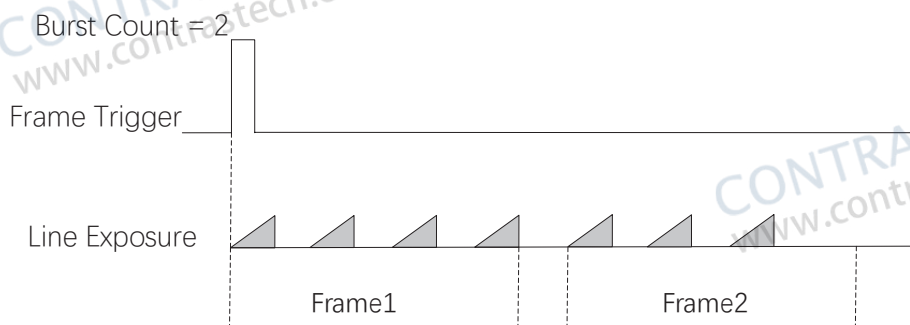

Trigger Mode

■ Trigger Activation

The device supports triggering image acquisition in the rising edge, falling edge, level high, level low or any edge of the external signal. Go to Acquisition Control → Trigger Activation, and select Rising Edge, Falling Edge, Level High or Level Low as Trigger Activation.

Trigger Activation	Parameter	Parameter Value	Principle
Rising Edge	Acquisition Control > Trigger Activation	Rising Edge	It means that when the level signal sent by external device is in rising edge, the device receives trigger signal and starts to acquire images.
Falling Edge		Falling Edge	It means that when the level signal sent by external device is in falling edge, the device receives trigger signal and starts to acquire images.
Any Edge		Any Edge	It means that when the level signal sent by external device is in rising or falling edge, the device receives trigger signal and starts to acquire images.
Level High		Level High	The level high of the trigger signal is valid. As long as the trigger signal is in level high, the device is in image acquisition status.
Level Low		Level Low	The level low of the trigger signal is valid. As long as the trigger signal is in level low, the device is in image acquisition status.



The setting method for trigger activation is different in frame trigger and line trigger.

● Set Trigger Activation in Frame Trigger

Go to Acquisition Control, and set Trigger Activation according to actual demands.

_ When rising edge, falling edge, or any edge is selected as FrameTrigger Activation, you can set trigger delay. When Line Delay Enable is enabled, set the number of trigger lines for delay in the FrameTrigger Delay, or when the Line Delay Enable is disabled, set the trigger time for delay in the FrameTrigger Delay.



The Line Delay Enable is valid only when the line trigger mode is enabled.

_ When level high or level low is selected as FrameTrigger Activation, the device will be triggered according to selected method.

Trigger Mode	On
Trigger Source	Line 0
Trigger Activation	Rising Edge
Trigger Delay(us)	Rising Edge
Trigger Cache Enable	Falling Edge
Sensor Shutter Mode	Level High
	Level Low



When Line 0/1/3 is selected as the trigger source in the frame trigger mode, the images are output during the level high by default.

● Go to Acquisition and Transfer Control → Line Trigger Control, and set LineTrigger Activation according to actual demands. In the line trigger mode, the trigger activation is related with Exposure Mode.

_ When you select Rising Edge, Falling Edge, or Any Edge as LineTrigger Activation, you can select Timed as Exposure Mode only, and Exposure Auto and Exposure Time determine the exposure time.

_ When you select Level Low or Level High as LineTrigger Activation, you can select Timed or Trigger Width as Exposure Mode. Exposure time is determined by the duration of the level signal only if Trigger Width is selected.

Trigger Mode

■ Trigger Delay

The trigger delay function allows the device to add a delay between the receipt of trigger signal and the moment the trigger becomes active.

Go to Acquisition and Transfer Control → Frame Trigger Control, and enable Line Delay

Enable and set FrameTrigger Delay.

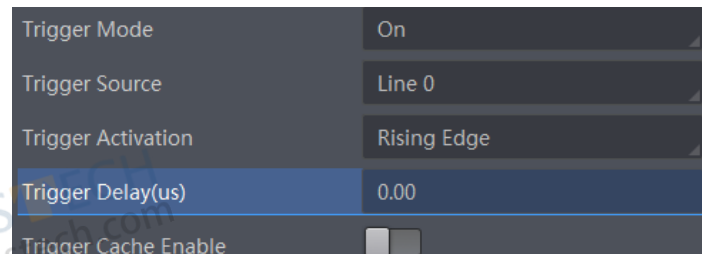
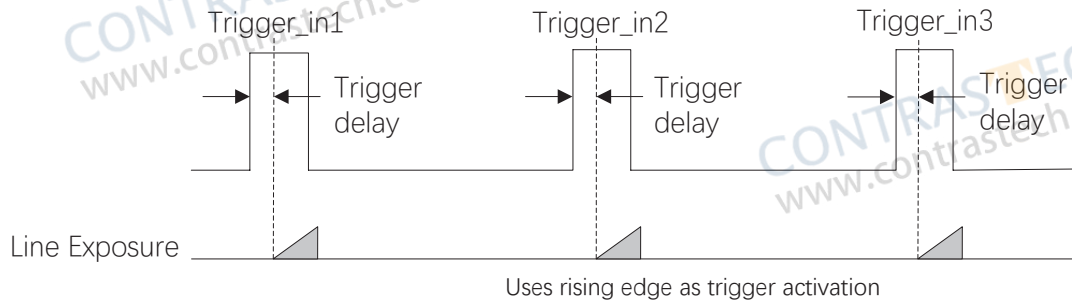

- The sequence diagram above uses rising edge as trigger activation.
- When Line Delay Enable is enabled, set the number of trigger lines for delay in the FrameTrigger Delay, or when the Line Delay Enable is disabled, set the trigger time for delay in the Trigger Delay.
- The Line Delay Enable is valid only when the line trigger mode is enabled.

■ Trigger Cache

If the device enables the frame trigger or line trigger, it has the frame/line trigger cache function. During the triggering process, if the device receives new trigger signal, it will save and process the signal if you enable this function. Trigger cache enable can save up to 3 trigger signals.



- The frame/line trigger cache function may differ by device models.
- The setting method for trigger cache is different in frame trigger and line trigger.

Set Trigger Cache in Frame Trigger

Go to Acquisition and Transfer Control → Frame Trigger Control, and enable FrameTrigger Cache Enable.

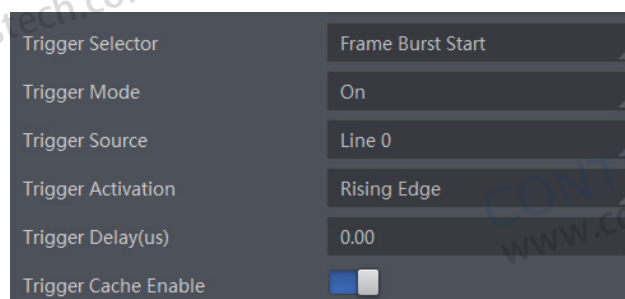

Trigger Mode

If the camera receives the 1st trigger signal first, and the camera receives the 2nd trigger signal during processing the 1st trigger signal. The three sequence diagrams below use rising edge as trigger activation, and the camera's height parameter is 4.

- Disable Trigger Cache Enable: the 2nd trigger signal will be filtered without processing.

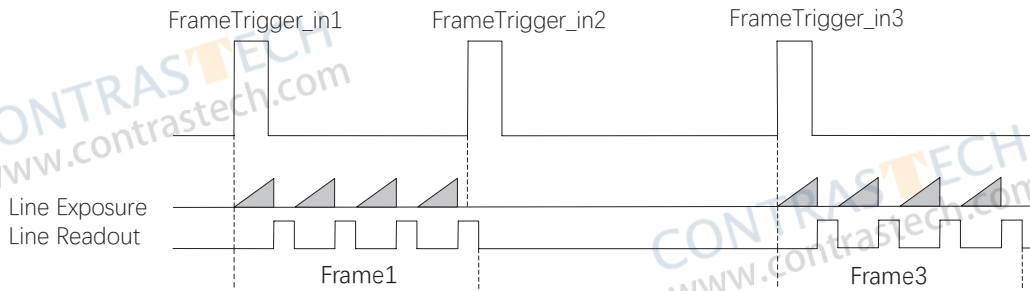

- Enable Trigger Cache Enable: the 2nd trigger signal will be saved.

_ If the 1st frame image's exposure time of the 2nd trigger signal is not earlier than the camera's last frame creation time of the 1st trigger signal, and then the 2nd trigger signal's 1st frame image is created normally.

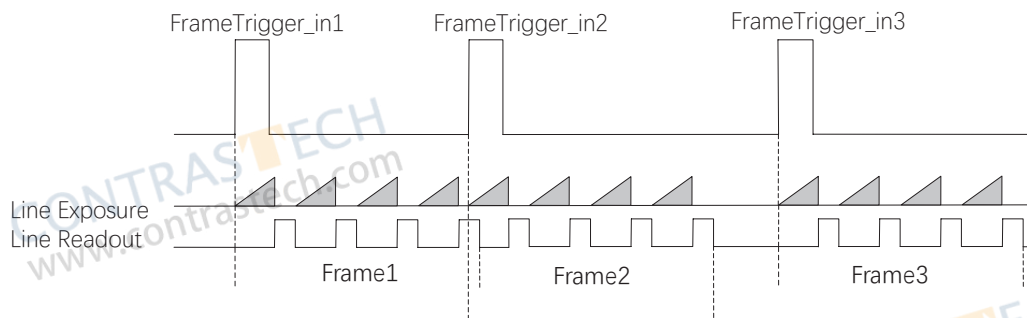

_ If the 1st frame image's exposure time of the 2nd trigger signal is earlier than the camera's last frame creation time of the 1st trigger signal, and then the camera will delay this exposure time. Thus making sure this exposure time is not earlier than the camera's last frame creation time of the 1st trigger signal.

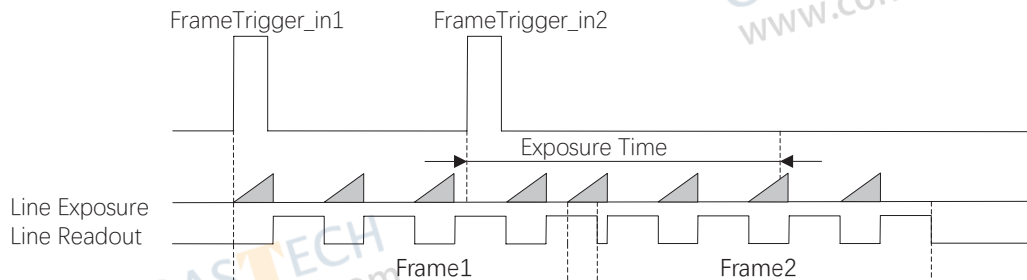

The three sequence diagrams above use rising edge as trigger activation, and the device's height parameter is 4.

Set Trigger Cache in Line Trigger

Steps:

Go to Acquisition and Transfer Control → Line Trigger Control, and enable Line Trigger Cache Enable.



This parameter can be set only when the Trigger Selector selects Line Start.

Trigger Mode

■ Trigger Debouncer

The trigger debouncer function allows the device to filter out unwanted short external trigger signal that is input to the device. Go to I/O Control → Line Debouncer Time, and enter Line Debouncer Time according to actual demands. The range of Line Debouncer Time is from 0 μ s to 1000000 μ s, and the step is 100 ns.



- If the Line Debouncer Time you set is greater than the time of trigger signal, this trigger signal will be ignored.
- The unit of Line Debouncer Time may differ by device models.
- The sequence diagram below uses rising edge as trigger activation.

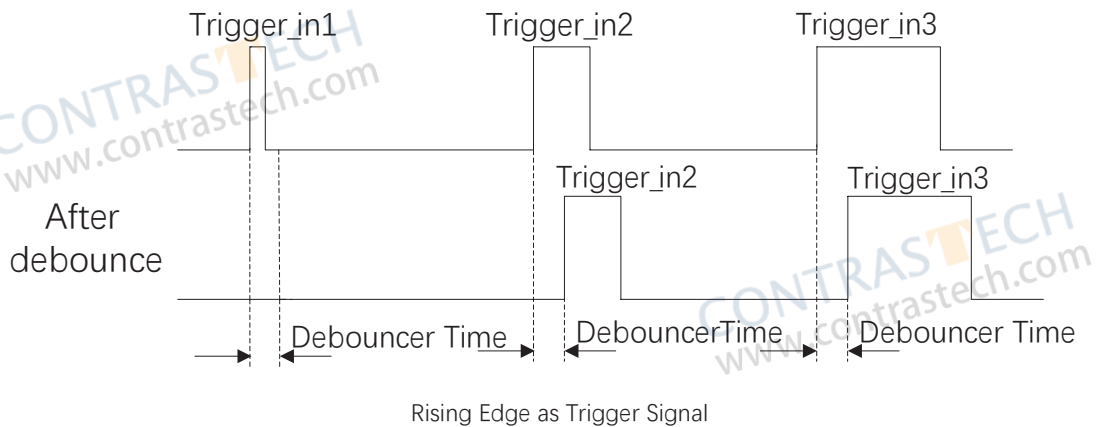
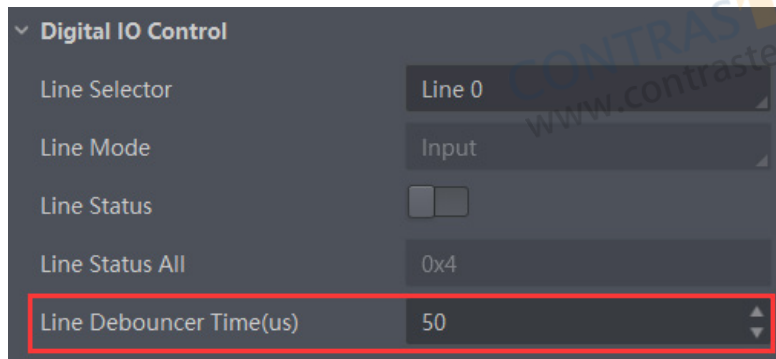

CHAPTER 5 I/O OUTPUT

Select Output Signal

The device has multiple bi-directional configurable lines. The method of setting bi-directional configurable line as output line as follows:

Steps

1. Go to I/O Control, and select specific line as Line Selector.
2. Set Strobe as Line Mode.
3. Set Line Format according to actual demands.



- Differential stands for the differential signal.
- If a bi-directional configurable line signal is selected as Line Selector and Line Mode is Input currently, but you cannot set Strobe as Line Mode. The reason is that the bi-directional configurable line signal is selected as trigger source in one of line trigger/frame trigger/shaft encoder control/ frequency converter control settings. You should set other line signals as trigger source in line trigger/frame trigger/shaft encoder control/ frequency converter control settings all.

The output signal of the device is switch signal that can be used to control external devices such as light source, PLC, etc. There are two ways to set output signal, including line inverter and strobe signal.

Set Output Signal

The output signal of the camera is switch signal, which is used to control external devices such as alarm light, light source and PLC. There are two ways to achieve output signal, including line inverter and strobe signal.

■ Enable Level Inverter

The line inverter function allows the device to invert the electrical signal level of an I/O line.

Go to Digital IO Control → Line Inverter, and enable it.

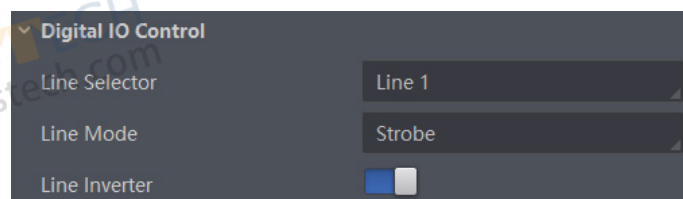

The line inverter function is disabled by default.

Set Output Signal

■ Enable Strobe Signal

The strobe signal is used to directly output I/O signal to external devices when the device's event source occurs.

If you need to let the device output signals when it outputs one frame image, follow steps below to set it.

Steps

1. Click Digital IO Control, and set Exposure Start Active as Line Source.
2. Select Frame Mode as Strobe Source Selector.
3. Enable Strobe Enable.

If you need to let the device output signals when event sources occur that are corresponding to each line image, follow steps below to set it.

Steps

1. Click Digital IO Control, and select Line Mode as Strobe Source Selector.
2. Set Line Source according to actual demands.
3. Enable Strobe Enable.

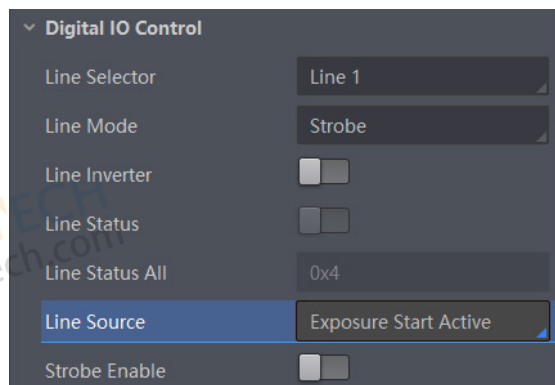

After selecting a specific line source, an event information will be generated, and the device will output a Strobe signal at the same time. The supported line sources are as follows:



The specific line sources may differ by device models.

Name	Description
Exposure Start Active	It refers to output one I/O edge signal when starting exposure.
Acquisition Start Active	It refers to output one I/O edge signal when starting acquisition.
Acquisition Stop Active	It refers to output one I/O edge signal when stopping acquisition.
Frame Burst Start Active	It refers to output one I/O edge signal when starting triggering and acquiring images under Burst mode.
Frame Burst End Active	It refers to output one I/O edge signal when stopping triggering and acquiring images under Burst mode.
Frame Start Active	The device outputs signals to external devices when it starts doing the capture of a frame.
Frame End Active	The device outputs signals to external devices when it stops doing the capture of a frame.
Soft Trigger Active	It refers to output one I/O edge signal when software trigger acquisition.
Hard Trigger Active	It refers to output one I/O edge signal when hardware trigger acquisition.
Counter Active	The camera outputs signals to external devices when counter trigger starts.
Timer Active	The camera outputs signals to external devices when timer trigger starts.

Set Output Signal

When Counter Active is selected as Line Source, you can go to Counter and Timer Control and set specific parameters according to actual demands.

Parameter	Read/Write	Description
Counter Selector	Read and write	It selects counter source. Counter 0 is available only at present.
Counter Event Source	Read and write	It selects the signal source of counter trigger, and Off, Line * or Link Trigger * is available. It is disabled by default. It is available only when Line* is set as Input.
Counter Event Activation	Read and write	It selects the activation mode of the selected counter event source, including rising edge, falling edge, and any edge.
Counter Reset Source	Read and write	It selects the signal source of resetting counter. Software is available only. It is disabled by default.
Counter Reset	Write is available under certain condition	It resets counter and it can be executed when selecting Software as Counter Reset Source.
Counter Value	Read and write	It is the counter value with the range of 1 to 4294967295. The specific range of counter value may differ by device models.
Counter Current Value	Read only	It displays the number of executed external trigger.

If Timer Active is selected as Line Source, you can set Strobe Line Duration and Strobe Line Delay, and the device will output signal correspondingly after click Execute in Line Trigger Software.

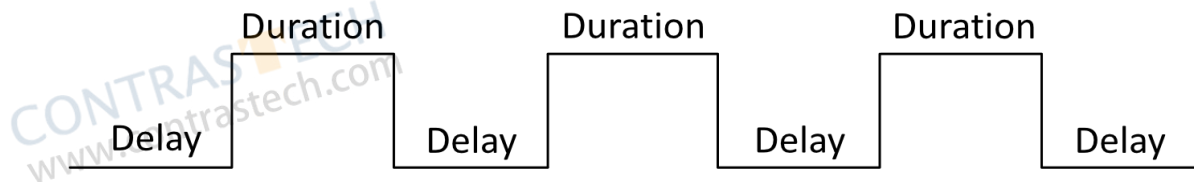

● Set Strobe Line Duration

After enabling strobe signal, you can set its duration. Click Digital IO Control > Strobe Line Duration, and enter Strobe Line Duration.

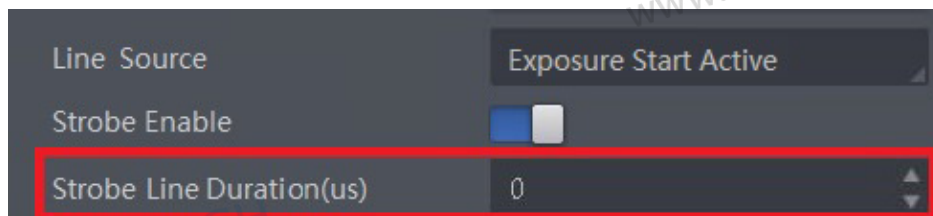

- When the Strobe Line Duration value is 0, the strobe duration is equal to the exposure time.
- When the Strobe Line Duration value is not 0, the strobe duration is equal to Strobe Line Duration value.

Set Output Signal

- Set Strobe Line Delay

The device supports setting strobe line delay to meet actual demands. When exposure starts, the strobe output doesn't take effect immediately. Instead, the strobe output will delay according to the strobe line delay setting.

Go to Digital IO Control → Strobe Line Delay, and enter Strobe Line Delay according to actual demands. The sequence diagram of strobe line delay is shown below.

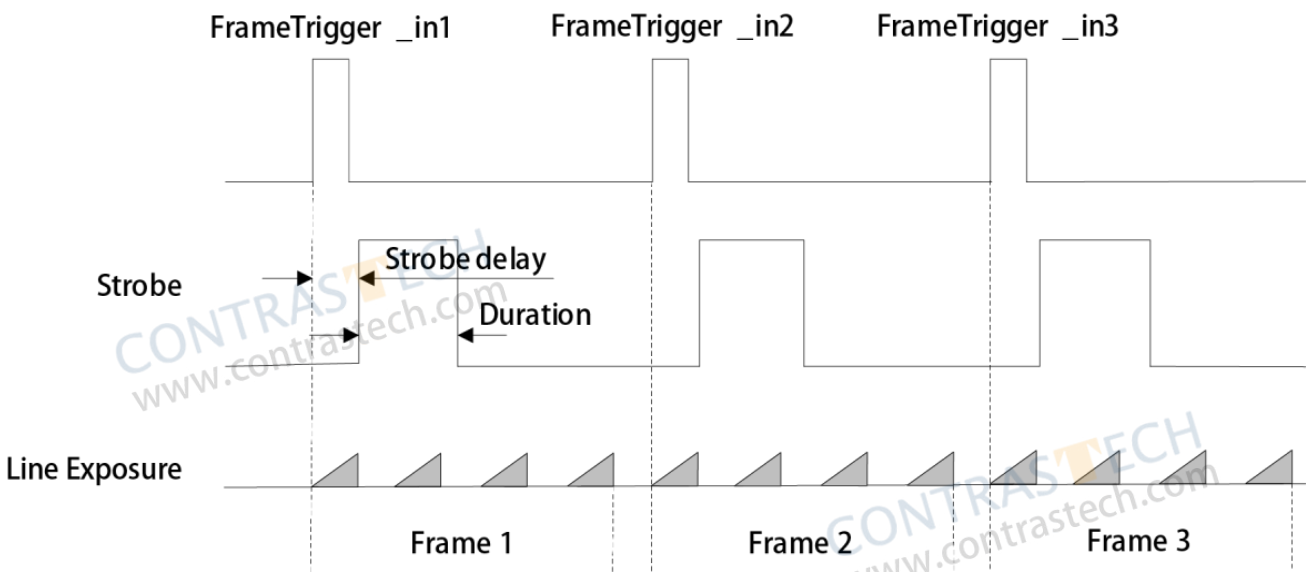
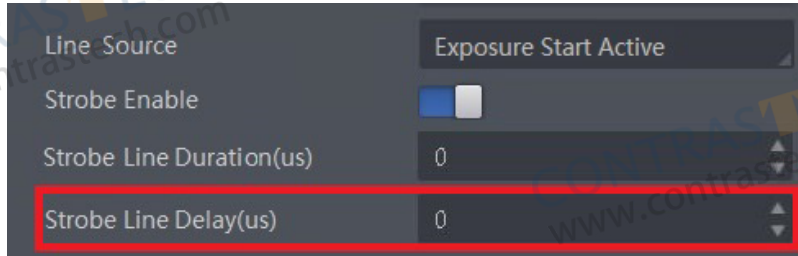

- The device's height parameter is 4 in the sequence diagram above.
- The range of the strobe line delay is from 0 to 10000, and the unit is μs .

Set Output Signal

● Set Strobe Line Pre Delay

The device also supports the function of strobe line pre delay, which means that the strobe signal takes effect early than exposure. This function is applied to the external devices that have slow response speed.

Go to Digital IO Control → Strobe Line Pre Delay, and enter Strobe Line Pre Delay according to actual demands. The sequence diagram of strobe line pre delay is shown below.

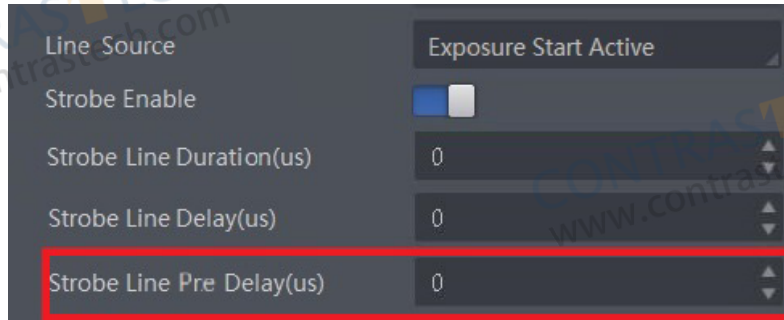

The sequence diagram of strobe line pre delay is shown below.

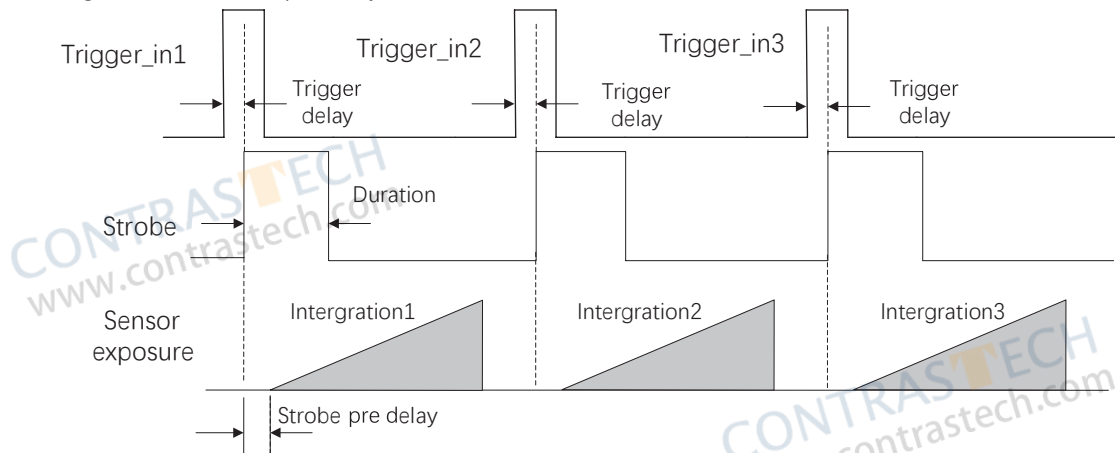

- The device's height parameter is 4 in the sequence diagram above.
- The range of the strobe line delay is from 0 to 10, and the unit is μs .

I/O ELECTRICAL FEATURE AND WIRING

CHAPTER 7

I/O Introduction

There are two types of I/O signals in accordance with pin definitions.

- The first type: Two differential input signals (Line 0/3), two differential output signals (Line 1/4), and one bi-directional configurable signal (Line 2).
- The second type: Four configurable input or output signals (Line 0/1/3/4), and these lines can be configured as differential input or differential output according to actual demands.

I/O Electrical Feature

■ Differential Input Circuit

The differential input signal in I/O signals supports the single-ended input, and its internal circuit is shown below.

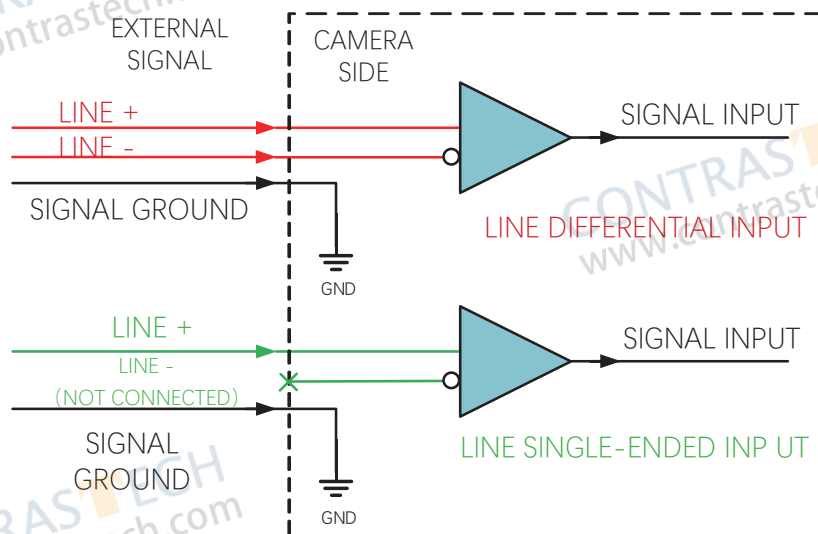

The RS-422 standard, RS-644 standard and TTL&LVTTTL standard input signal are applied to the differential input.

● RS-422 Standard Input

In order to make sure the normal operation of input circuit, it is required to connect camera's ground signal with external ground signal if the differential input adopts RS-422 standard signal.

RS-422 standard defines the connection of the bus structure, and the inputs of several cameras can be connected to the RS-422. Up to 10 cameras can be connected at the same time, of which only one camera is the master dispenser and other cameras are receivers. The circuit length between the receiver and the bus should be as short as possible. The bus must have a 120 Ω terminal resistance.

When the camera is the last receiver on the bus structure, the camera's terminal resistance needs to be enabled, and the rest camera's terminal resistance need to be disabled. Multiple terminal resistance should not be enabled on the bus structure, which will reduce signal reliability and may cause damage to the RS-422 device.

● RS-644 Standard Input

If the differential input adopts RS-644 standard signal, the input terminal must enable 120 Ω terminal resistance.

● TTL&LVTTTL Standard Input

If the differential input adopts TTL&LVTTTL standard signal, the input terminal's 120 Ω terminal resistance must be disabled, and its input electrical feature requirement is shown below.

I/O Electrical Feature

Voltage	Description
0 V-1 V	Level low
1 V-3 V	Unstable voltage, and it is not recommended to use it.
3.3 V-24 V	Level high

■ Differential Output Circuit

The differential input signal in I/O signals supports the single-ended input, and its internal circuit is shown below.

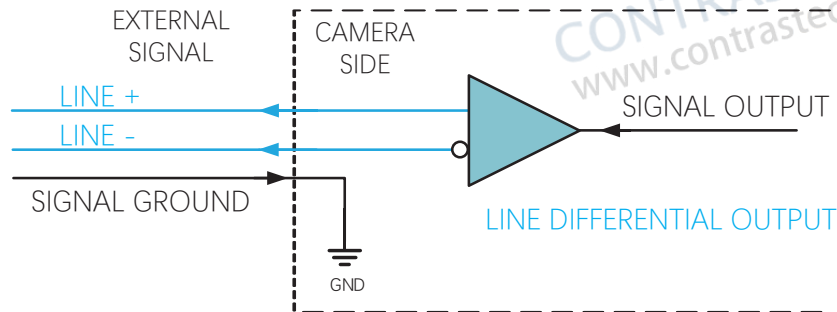

The RS-422 standard and RS-644 standard are applied to the differential output.

● RS-422 Standard Output

In order to make sure the normal operation of output circuit, it is required to connect camera's ground signal with external ground signal. The output interface can be connected to the RS-422 bus structure as a master dispenser.

● RS-644 Standard Output

The camera adopting RS-422 standard output signal cannot directly connect to RS-644 standard. When connecting RS-644 standard output, it is required to add a resistance network in camera's output location. In order to make sure the normal operation of output circuit, it is required to connect camera's ground signal with external ground signal.

I/O Wiring

Input Wiring

The device can receive input signals via the hardware trigger to acquire images. The input signals include differential signal and single-ended signal.



- Make sure that the hardware trigger signals have been configured as input signal.
- It is recommended to connect Line 0 or Line 4 if the input signal is 24 V, avoiding damage to the I/O interface caused by excessive voltage.

The wiring is shown below if the differential signal source provides trigger signal.:

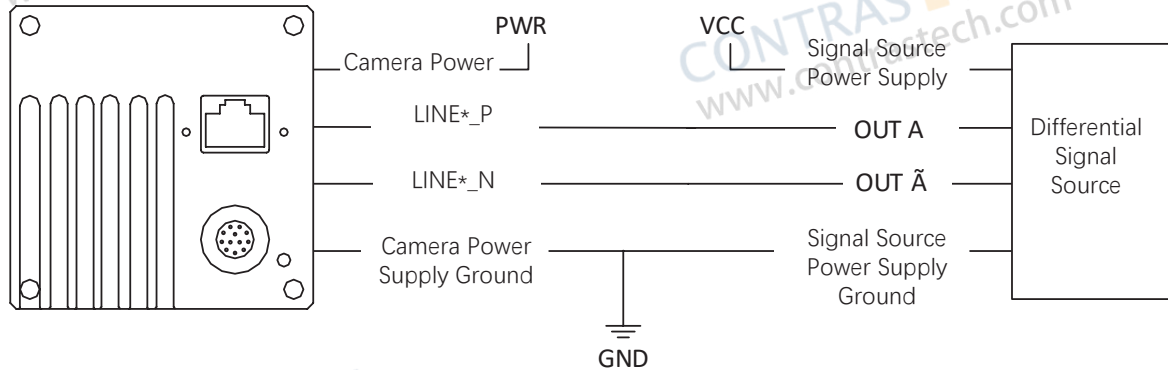

PNP Single-Ended Input Wiring Without Pull-Down Resistor:

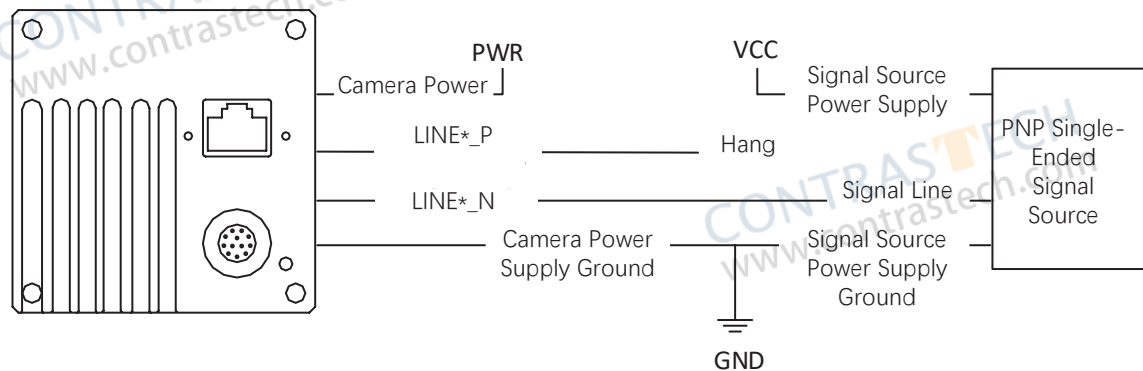

PNP Single-Ended Input Wiring with Pull-Down Resistor (1 KΩ to 4.7 KΩ)

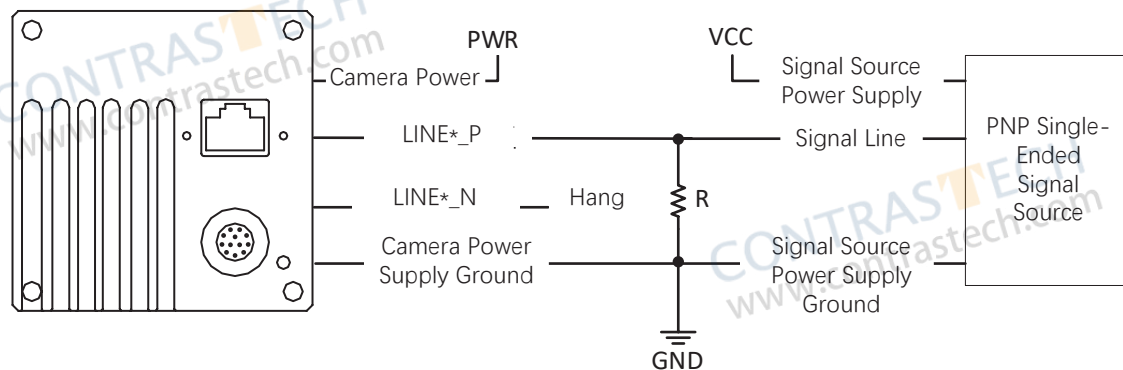

I/O Wiring

NPN Single-Ended Input Wiring Without Pull-Up Resistor

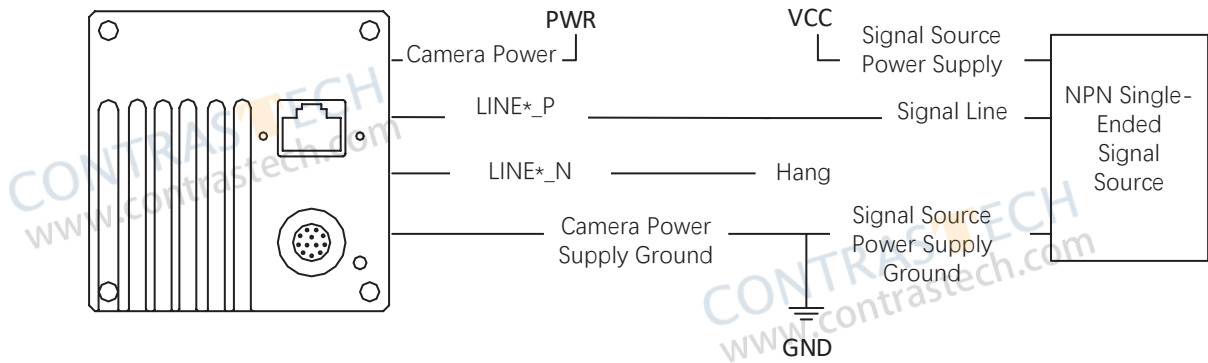

NPN Single-Ended Input Wiring with Pull-Up Resistor (1 K Ω to 10 K Ω)

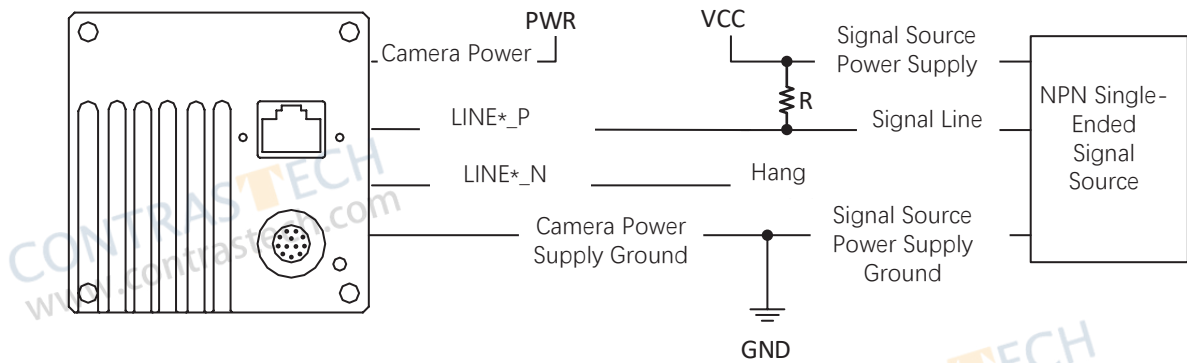

I/O Wiring

Output Wiring

The device's 2 bi-directional I/O lines can be configured to output signal to trigger other devices.

If I/O signals are used as differential output, the wiring is shown below.

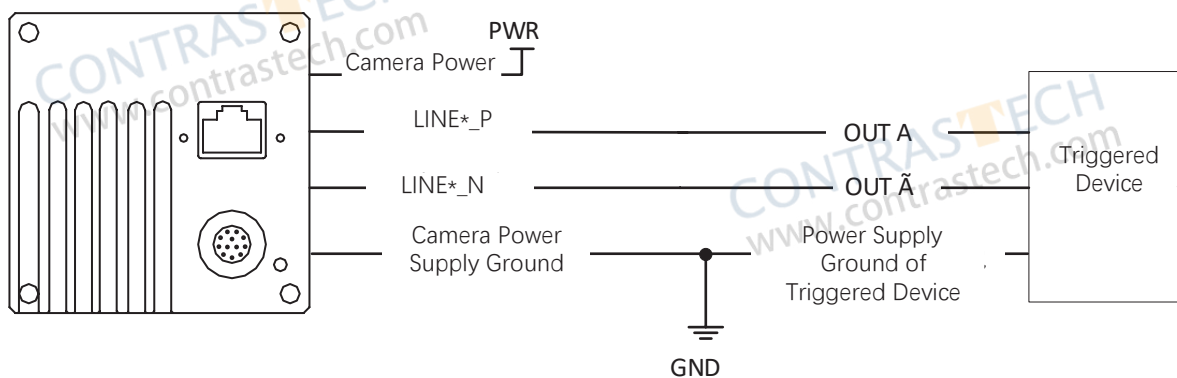

If I/O signals are used as single-ended output, a pull-up resistor of 1 k Ω to 10 k Ω needs to be added. The value of the VCC voltage should match with that of the required trigger voltage.

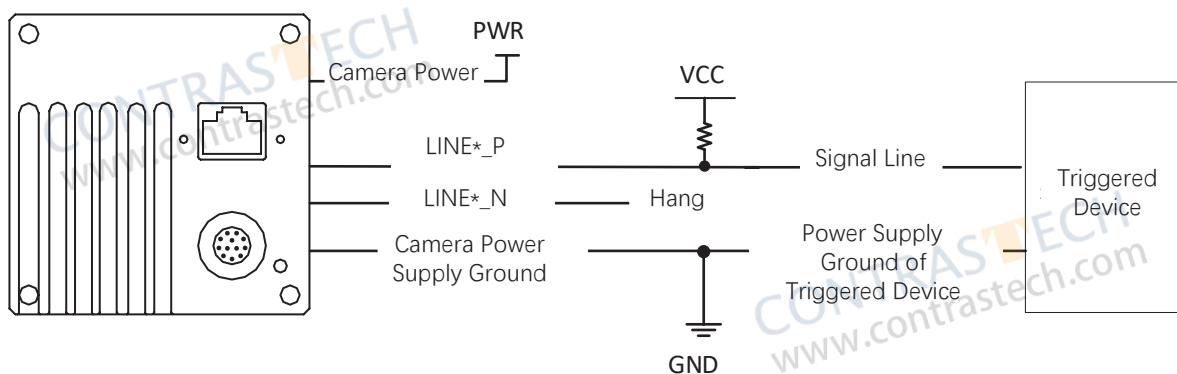

CHAPTER 8 IMAGE PARAMETER

Resolution and ROI



The device displays the image with max. resolution by default.

Go to Image Format Control, and you can view resolution by reading Width Max and Height Max. Width Max stands for the max. pixels per inch in width direction, and Height Max stands for the max. pixels per inch in height direction.

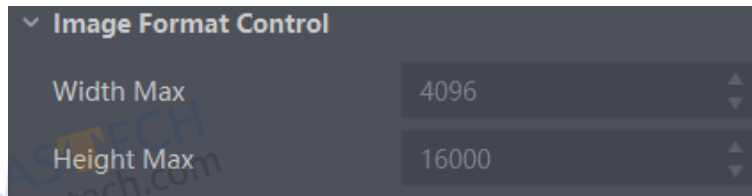

If you are only interested in a certain region of the image, you can set a Region of Interest (ROI) for the device.



- The device currently supports one ROI only, and you can select Region 0 as Region Selector.
- Region of interest can be set only when you stop real-time acquisition.

Go to Image Format Control → Region Selector, and enter Width, Height, and Offset X.

- Width: it stands for horizontal resolution in ROI area.
- Height: it stands for vertical resolution in ROI area.
- Offset X: it refers to the horizontal coordinate of the upper left corner of the ROI.
- Offset Y: it refers to the vertical coordinate of the upper left corner of the ROI.

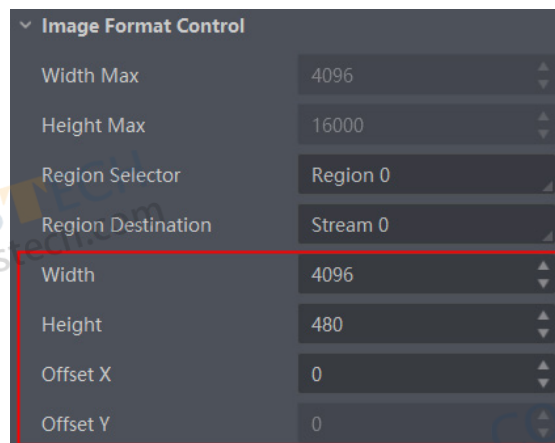

The Width plus Offset X should not be larger than Width Max, and Height should not be larger than Height Max.

Image Reverse

The device supports reversing images in a horizontal way. Go to Image Format Control, and enable Reverse X according to actual demands.



The image reverse function may differ by camera models.

Pixel Format

This function allows you to set the pixel format of the image data transmitted by the device. Go to Image Format Control → Pixel Format, and set Pixel Format according to actual demands.



- The specific pixel formats may differ by device models.
- If there is no need to identify the color of the object, it is recommended to use a mono camera.

Pixel Format	Pixel Size (Bits/Pixel)
Mono 8、Bayer 8、Bayer RBGG 8	8
Mono10 Packed、Mono 12 packed、Bayer 10 Packed、Bayer 12 Packed	12
Mono 10/12、Bayer 10/12	16
RGB 8、BGR 8	24

The default output data format of mono device is Mono 8. The default output data format of color device is Bayer 8, and it can be converted into RGB format via pixel interpolation algorithm. RGB format can be converted into BGR format via the order adjustment.

Bayer GR, Bayer GB, Bayer BG, Bayer RG and Bayer RBGG patterns are shown below.



Bayer GR



Bayer GB



Bayer BG



Bayer RG



Bayer RBGG

Click Image Format Control > Pixel Format, and set Pixel Format according to actual demands.

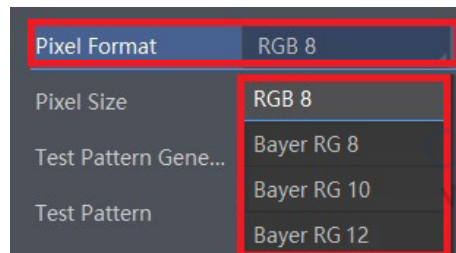

Image Compression Mode

Without affecting image quality, this function allows the device to compress data before transmitting to the external devices, and lower the usage of bandwidth.

Steps

1. Go to Image Format Control → Image Compression Mode.
2. Select HB as Image Compression Mode.



The function of the image compression is related with camera models, firmware and pixel format, and the actual product you purchased should prevail.

3. View the image compression mode's related parameters like HB Abnormal Monitor and HB Version in the Device Control attribute.

● HB abnormal monitor is used to monitor image stream condition. If the size of compressed image is larger than that of raw image under HB function, this parameter will increase. When this parameter increases rapidly, it is recommended to disable the image compression mode.

● HB version refers to the version of this function.

Test Pattern

The device supports test pattern function. When there is exception in real-time image, you can check whether image of test mode have similar problem to determine the reason. This function is disabled by default, and at this point, the outputted image by the device is real-time image. If this function is enabled, the outputted image by the device is test image.

Go to Image Format Control → Test Pattern Generator Selector → Test Pattern, and set Test Pattern according to actual demands.

The mono device offers 5 test patterns, including Mono Bar, Checkboard, Oblique Mono Bar, Gradual Mono Bar, and Test Image 1. The color device offers 7 test patterns, including Mono Bar, Checkboard, Oblique Mono Bar, Gradual Mono Bar, Vertical Color Bar, Horizontal Color Bar, and Test Image 1.

- The pattern of Vertical Color Bar/Horizontal Color Bar are not supported by the mono device.
- The pattern may differ by device models.

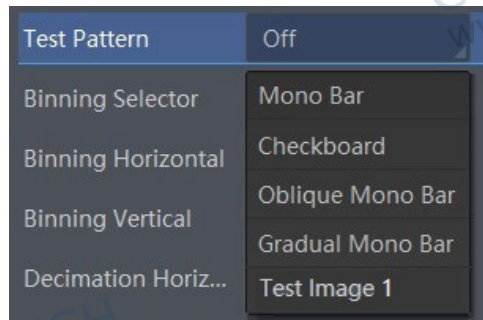

Fig:Mono Bar



Fig:Oblique Mono Bar

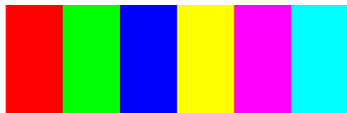

Fig:Vertical Color Bar



Fig:Test Image 1



Fig:Test Image 2



Fig:Horizontal Color Bar

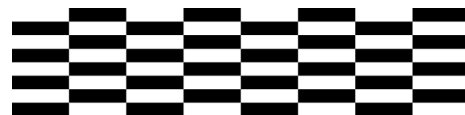

Fig:Checkboard

Binning

The purpose of setting binning is to enhance sensibility. With binning, multiple sensor pixels are combined as a single pixel to reduce resolution and improve image brightness.

For a color device, it merges the pixel values of adjacent pixels of the same color horizontally, as shown below.



Binning Horizontal 2



Binning Vertical 2

If the horizontal binning coefficient and the vertical binning coefficient of the color device are both configured to 2, the device merges the 4 adjacent sub-pixels of the same color according to the corresponding position, and outputs the merged pixel value as a sub-pixel, as shown below.



Binning Horizontal 2 and Binning Vertical 2

Click Binning Selector, and set Binning Horizontal and Binning Vertical according to actual demands.

Binning Selector	Region 0
Binning Horizontal	2
Binning Vertical	2



- Binning Horizontal is the image's width and offset X, and Binning Vertical is the image's height.
- If the device's vertical resolution is 1, and then there is no Binning Vertical.
- The binning function may differ by device models.

Exposure Mode

The exposure mode supports Timed and Trigger Width. When selecting Timed, you can set Exposure Auto and Exposure Time. When you select Trigger Width, the exposure time and level signal time are the same, and Exposure Auto and Exposure Time are invalid.

i

The Trigger Width can be selected as the Exposure Mode when the requirements below are met:

- LineTrigger Mode in Line Trigger Control is enabled.
- Line * is selected as the LineTrigger Source.
- Level High or Level Low is selected as LineTrigger Activation.

The Exposure Auto supports 3 types, including Off, Once and Continuous. Go to Acquisition and Transfer Control → Exposure Auto, and select Exposure Auto according to actual demands.

Exposure Method	Parameter	Principle
Off		The camera exposures according to the value configured by user in Exposure Time.
Once	Acquisition Control > Exposure Auto	Adjust the exposure time automatically according to the image brightness. After adjusting, it will switch to Off Mode.
Continuous		Adjust the exposure time continuously according to the image brightness.

When the exposure mode is set as Once or Continuous, the exposure time should be within the range of Auto Exposure Time Lower Limit (μs) and Auto Exposure Time Upper Limit (μs).

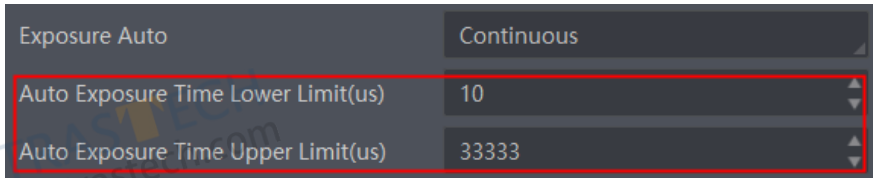

Brightness

The device brightness refers to the brightness when the device adjusts image under Once or Continuous exposure mode.

i

- You should enable Once or Continuous exposure mode first before setting brightness.
- After setting brightness, the device will automatically adjust exposure time to let image brightness reach target one. Under Once or Continuous exposure mode, the higher the brightness value, the brighter the image will be.
- The range of brightness is between 0 and 255.

Go to Analog Control → Brightness, and enter Brightness according to actual demand.

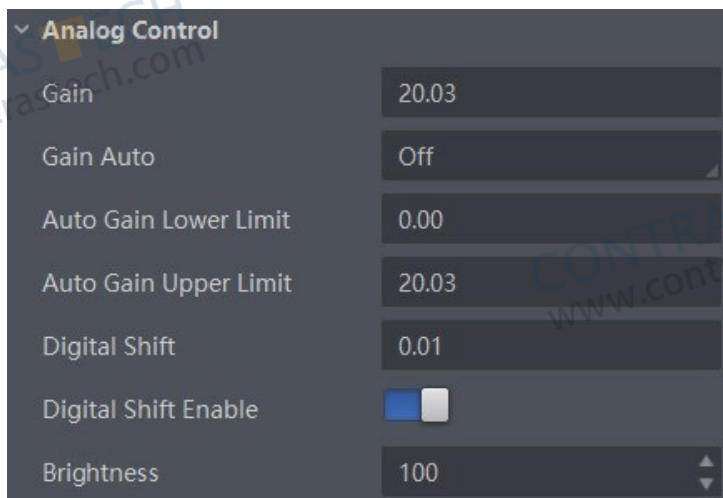

White Balance

White balance is only available for color cameras.

The white balance refers to the camera color adjustment depending on different light sources. Adjust the Gain Value of the image's R channel and B channel to keep white regions white under different color temperatures. Ideally, the proportion of R channel, G channel and B channel in the white region is 1:1:1.

The device supports 3 types of white balance mode, including Off, Once and Continuous.

Click Analog Control → White Balance Auto, and select White Balance Auto according to actual demands.

White Balance Mode	Parameter	Principle
Off	Analog Control > Balance White Auto	You need to set the R, G, B value manually, between 1 and 4095. 1024 means ratio is 1.0
Once		Automatic white balance once. Adjust the white balance for a certain amount of time then stop. It implements an algorithm that finds possible gray areas in the Bayer data.
Continuous		Continuous automatic white balance. It implements an algorithm that finds possible gray areas in the Bayer data.

It is recommended to correct white balance when there is great difference between the camera's color effect and actual effect. You can correct white balance as shown below.

Steps:

1. Put a white paper in the range of the camera's field of view, and make sure the paper covers the entire field of view.
2. Set exposure and gain. It is recommended to set image brightness value between 120 and 160.
3. Select Once as Balance White Auto, and the camera will automatically adjust white balance for once.

Balance White Auto parameter defaults to Continuous, and AWB Color Temperature Mode is Narrow. If the color effect of the image is still not good after performing automatic white balance in this color temperature mode, you can set the AWB Color Temperature Mode parameter to Wide and then perform automatic white balance correction.

If there is still great difference between correction effect and actual color, it is recommended to correct white balance according to following steps.

Steps:

1. Select Off as Balance White Auto. At this time, Balance Ratio is 1024.
2. Find corresponding R/G/B channel in Balance Ratio Selector. Here we take Green as an example.
3. Find camera's R/G/B value.
4. Take Green as correction standard, and manually adjust other two channels (R channel and B channel) to let these three channels have same value.





- Here we take Green as an example. For specific Balance Ratio Selector value, please refer to the actual condition.
- In order to avoid repeated correction after rebooting the camera, it is recommended to save white balance parameter to User Set after white balance correction. You can refer to the Section Save and Load User Set for details.
- If the light source and color temperature in environment change, you need to correct white balance again.

Black Level

The device supports black level function that allows you to change the overall brightness of an image by changing the gray values of the pixels by a specified amount.

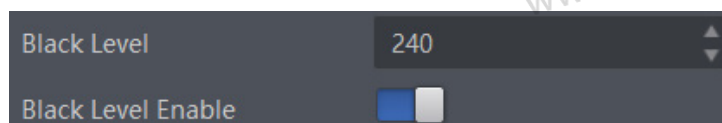
Go to Analog Control → Black Level Enable, enable Black Level Enable, and enter Black Level according to actual demands.





The black level function may differ by camera models.

Gamma Correction

The camera supports Gamma correction function. Generally, the output of the camera's sensor is linear with the photons that are illuminated on the photosensitive surface of the sensor. Gamma correction provides a non-linear mapping mechanism as shown below.

- Gamma value between 0.5 and 1: image brightness increases, dark area becomes brighter.
- Gamma value between 1 and 4: image brightness decreases, dark area becomes darker.

i Gamma correction is not supported under Bayer format for LEO 2048-L32gc cameras.

Gamma Curve

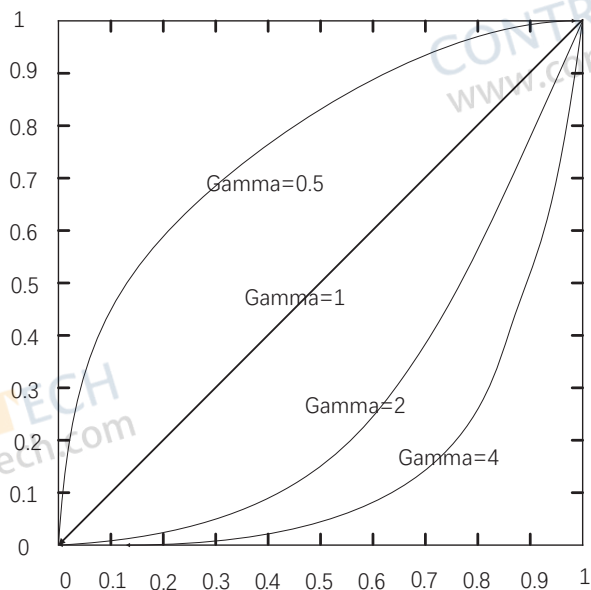

There are 2 types of Gamma correction, including User mode and sRGB mode.

User is a user-defined mode, which can set the value of Gamma; sRGB is a standard protocol mode.

■ You can set User mode as shown below.

1. Click Analog Control > Gamma Selector.
2. Select User as Gamma Selector.
3. Enable Gamma Enable.
4. Enter Gamma according to actual demands, and its range is from 0 to 4.

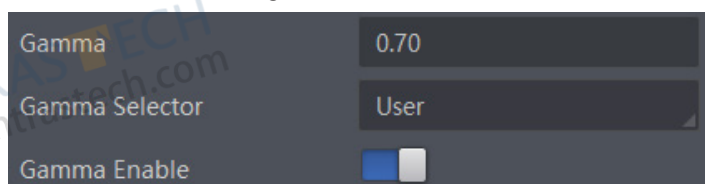

■ You can set sRGB mode as shown below.

1. Click Analog Control > Gamma Selector.
2. Select sRGB as Gamma Selector.
3. Enable Gamma Enable.

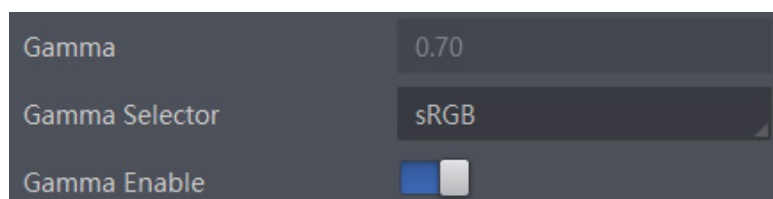

Gain

i The gain function may differ by device models.

The device has 2 types of gain, including the analog gain and digital gain. The analog gain is applied before the signal from the device sensor is converted into digital values, while digital gain is applied after the conversion.

■ Analog Gain

i

- The analog gain parameter name may differ by device of different models or firmware. The analog gain parameter name can be Preamp Gain or Gain which have different settings method.
- When the analog gain parameter is Preamp Gain, you can set it manually only.

The gain function may differ by camera models.

● Gain

The camera supports 3 types of analog gain modes: Off, Once and Continuous. Click Analog Control, and select Gain Auto according to actual demands. The analog gain mode and principle are shown below.

Gain Mode	Parameter	Principle
Off	Analog Control > Gain Auto	The camera adjusts gain according to the value configured by user in Gain.
Once		Adjust the gain automatically according to the image brightness. After adjusting, it will switch to Off Mode.
Continuous		Adjust the gain continuously according to the image brightness.

When the analog gain is set as Once or Continuous, the gain should be within the range of Auto Gain Lower Limit and Auto Gain Upper Limit.

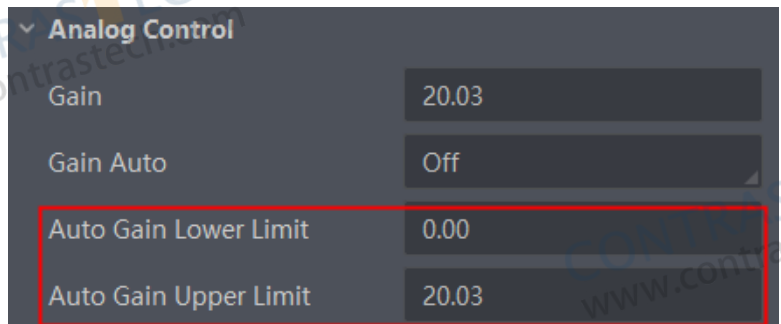

If the current gain settings cannot meet demands and images are dark, you can enable ADC Gain x 4 Enable to allow you to set a larger gain, and it adds additional 12 dB to the value you set.

● Preamp Gain

Click Analog Control > Preamp Gain, and enter Preamp Gain according to actual demands.

■ Digital Gain

Apart from analog gain, the device supports digital gain function. When analog gain reaching its upper limit and the image is still too dark, it is recommended to improve image brightness via digital gain.

Click Analog Control, enable Digital Shift Enable, and enter Digital Shift according to actual demands.

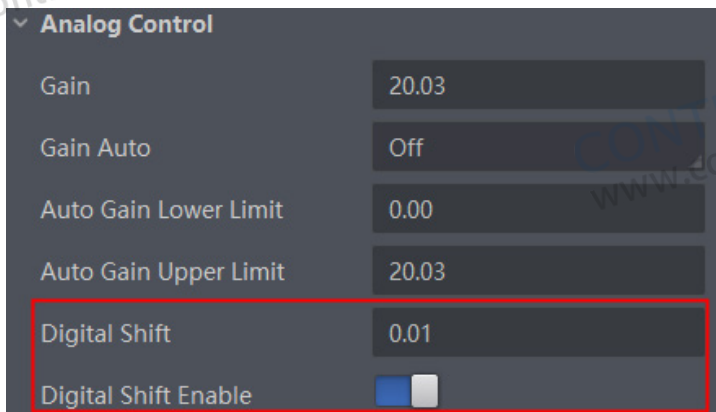

i When increasing the digital gain, the image noise will greatly increase too, which will severely influence image quality. It is recommended to use analog gain first, and then to adjust digital gain if the analog gain cannot meet demands.

Sensor Mode

The device provides two types of sensor mode, including high full well mode and high sensitivity. Go to Image Format Control → Sensor Mode, and set this parameter according to actual demands.

- High Full Well Mode: It provides a higher dynamic range, enhancing image clarity and reducing noise. It is applicable for the environment with low illumination
- High Sensitivity: It is selected by default. In this mode, the device provides better photosensitivity performance and the brighter image.

i

- The sensor mode function may differ by device models.
- The sensor mode can be set only when 2/4-TDI is selected as TDI Mode. Refer to Set TDI Function for details.

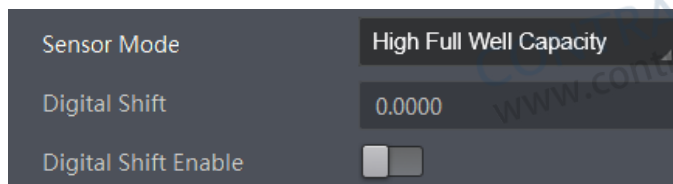

AOI

i

- The AOI function may differ by device models.
- AOI 1 is used to adjust the brightness when the device is in once or continuous exposure mode, and AOI 2 is used to adjust the white balance when the color device is in once or continuous white balance mode.

The device supports AOI function that can adjust the brightness and white balance of the entire image based on the area you selected.

Steps

1. Click Advanced Processing → AutoFunctionAOI Control → Auto Function AOI Selector, and select AOI 1 or AOI 2.
2. Enter Auto Function AOI Width, Auto Function AOI Height, and Auto Function AOI Offset X according to actual demands.
3. Enable Auto Function AOI Usage Intensity if AOI 1 is selected as Auto Function AOI Selector. Or enable Auto Function AOI Usage White Balance if AOI 2 is selected as Auto Function AOI Selector.

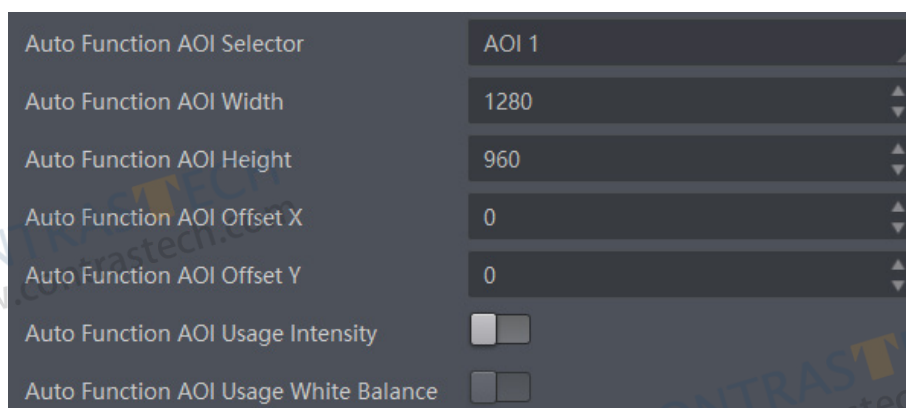

Color Transformation Control



- The function of color transformation control is only available for color devices.
- Currently, RGBtoRGB is available for Color Transformation Selector only.
- If the pixel format is Bayer, this function is not supported.

Steps

1. Go to Color Transformation Control, and enable CCM Enable.
2. You can enable/disable Color Transformation Enable to set this function.

When Color Transformation Enable is disabled, you can set Color Transformation Value according to actual demand.

When Color Transformation Enable is enabled, you can set hue and saturation to control color transformation value.

Hue



- The hue function is only available for color devices.
- In Mono pixel format, hue function is not supported.
- The range of hue is between 0 and 255.

Adjusting the hue shifts the colors of the image. After hue is set, the device will perform color correction based on the hue value to bring the image tone to the target value. For example, when hue is set to 128, the red in the image appears as real red. When hue is 0, the hue is reversed 128 degrees counterclockwise, and red becomes blue. When hue is 255, the hue rotates 128 degrees clockwise, and red becomes green. Image examples of different hue values are shown below.

Before You Start

Make sure the Pixel Format of the color device is RGB, or BGR, and enable Color Transformation Enable.

Steps

1. Go to Color Transformation Control, and enable Hue Enable.
2. Enter Hue according to actual demands.

Saturation



- The saturation function is only available for color devices.
- In Mono pixel format, saturation function is not supported.
- The range of saturation is between 0 and 255.

Adjusting the saturation changes the colorfulness of the colors. A higher saturation, for example, makes colors easier to distinguish.

Steps

1. Go to Color Transformation Control, and enable CCM enable.
2. Enable Color Transformation Enable, and enable Saturation Enable.
3. Enter Saturation according to actual demands.

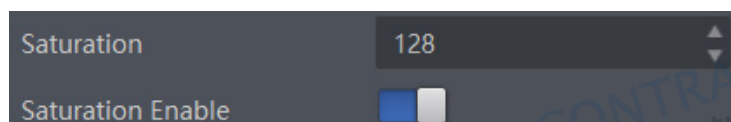

TDI Function

TDI refers to Time Delay Integration, and it is a method of line scanning which provides dramatically increased responsivity compared to other video scanning methods. It permits much greater scanning speeds in low light, or allows reduced lighting levels (and costs) at conventional speeds. In general, there are 3 TDI modes, including 1 line, 2-TDI, and 4-TDI.

- 1 line refers to single line mode, and the device selects 1 line data as output result.
- 2-TDI means that the device overlaps 2 adjacent line data, and outputs 1 line data as final result.
- 3-TDI means that the device overlaps 3 adjacent line data, and outputs 1 line data as final result.
- 4-TDI means that the device overlaps 4 adjacent line data, and outputs 1 line data as final result.

Go to Image Format Control → TDI Mode, and set TDI Mode according to actual demands.



The TDI function may differ by device models.

LUT

A Look-Up Table (LUT) is a customizable grayscale-mapping table. You can stretch, amplify the grayscale range that interests you. The mapping can be linear or customized curve.



- You cannot use Gamma correction function and LUT function at the same time.
- For the device that supports TDI function, the LUT should be executed again after you switch to TDI mode.
- The range of the LUT index is from 0 to 1023.
- The range of the LUT value is from 0 to 4095. The value of LUT value is four times the value of LUT index by default.

Steps:

1. Click LUT Control, and enable LUT Enable.
2. Enter LUT Index and LUT Value according to actual demands.
3. Click Execute in LUT Save to save it.

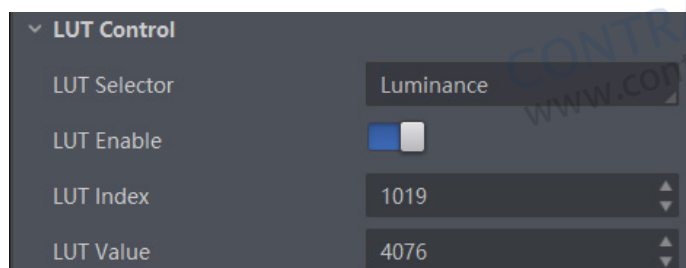

Shading Correction

The flat field correction (FFC) includes PRNUC correction and FPNC correction, and they are used to improve the image uniformity that may be impacted by the sensor, light sources, external conditions, etc.

■ FPNC

Step:

1. Click Shading Correction, and User Flat Field Correction is disabled by default.
2. Select one User FPNC from FPNC User Selector.
3. Click Execute in FPNC Correction, or click Open Tool in Flat Field Correction Tool and click Perform FPN Calibration.
4. Enable User Flat Field Correction.

 After User Flat Field Correction is enabled, you can enable FPNC correction and PRNUC correction at the same time.

The status of FPNC correction process can be viewed via Correction State. There are five statuses in total:

- All Finished: It means that the correction is done.
- Doing Correction: It means that the correction is executing.
- Saving Data: It means that the correction data is saving.
- Transferring Data: It means that the correction data is sending.
- Error: It means that the correction fails.

 The status of PRNUC correction process can also be viewed via Correction State.

■ PRNUC

The device supports PRNUC (Photo-Response Non-Uniformity Correction) function that eliminates vertical line on the images. Two correction methods are available, including global correction and ROI correction. The effect of PRNUC correction is shown blow.



Before PRNUC Correction



After PRNUC Correction

Global PRNUC (Photo-response Non-Uniformity Correction)

Steps:

1. Click Shading Correction, and User Flat Field Correction is disabled by default.
2. Select one User PRNUC from PRNUC User Selector.
3. Set PRNUC target related parameters according to actual demands.
 - Disable PRNUC Target Enable if you want to use the device's auto correction standard. At this time, the device compares and corrects the average gray value of each column with the average gray value of the entire image.
 - Enable PRNUC Target Enable if you want to manually correct. For mono devices, set PRNUC Target. At this time, the device compares and corrects the average gray value of each column with the configured gray value.
4. Click Execute in PRNUC Correction, or click Open Tool in Flat Field Correction Tool and click Perform PRNUC Calibration.
5. Enable User Flat Field Correction.

 After User Flat Field Correction is enabled, you can enable FPNC correction and PRNUC correction at the same time.

Shading Correction

ROI PRNUC Correction(Shading Correction Function)

If you want to execute PRNUC correction for specific areas, set PRNUC Width and PRNUC Offset X to set ROI, and enable PRNUC ROI Extension Enable to execute PRNUC Correction out of the ROI.

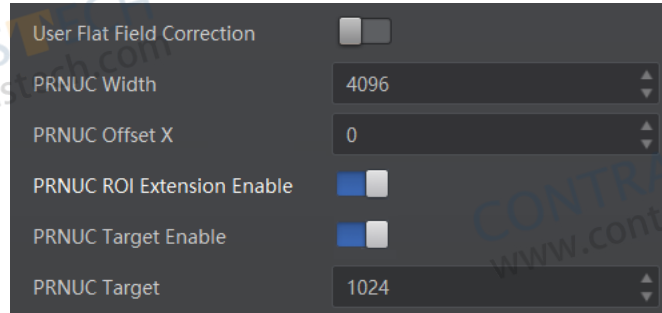

Color Abnormal Correction

The color abnormal correction (CAC) is used to eliminate abnormal color on image edges.

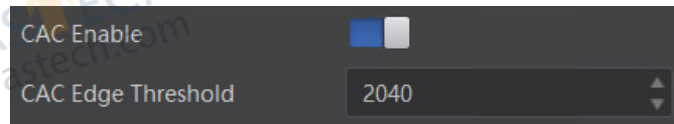

Steps

1. Go to Shading Correction → CAC Enable, and enable CAC Enable.
2. Enter CAC Edge Threshold according to actual demands.



- The color abnormal correction function may differ by device models.
- The CAC will be performed only when the edge strength is higher than the configured threshold.

Space Correction



The space correction function may differ by device models.

The space correction (SC) includes line rate deviation correction and parallax deviation correction, and they are used to reduce image details deviation caused by line rate deviation or pixel deviation.

Line Rate Ratio

You can go to Shading Correction, and set Line Rate Ratio according to actual demands.

Line rate ratio is used to adjust the ratio between the device's line rate and that of the actual object to adjust the pixel deviation between upper line and lower line in images.

Refer to the table below for effect contrast.

Type	Normal Image	Abnormal Image
Mono		
Color		

- It is recommended to set line rate ratio larger than 1 when the device's line rate is larger than that of the object.
- It is recommended to set line rate ratio smaller than 1 when the device's line rate is smaller than that of the object.
- It is recommended to set line rate ratio as 1 when the device's line rate is equal to that of the object.

Space Correction

Pixel Shift and Parallax Direction

When pixel deviation occurs, images of mono devices are vague and images of color devices are dispersive. If you find the image's edge has pixel deviation via observation, follow steps below to alleviate it. Refer to the table below for effect contrast.

i If the overall image has the phenomenon below, it may be caused by lens optical structure deviation.

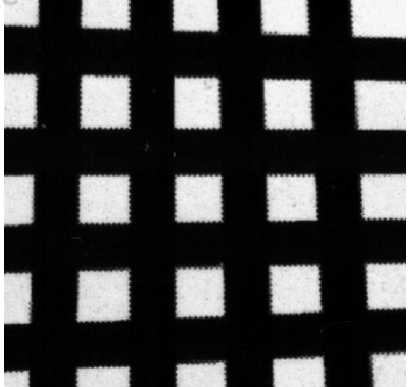
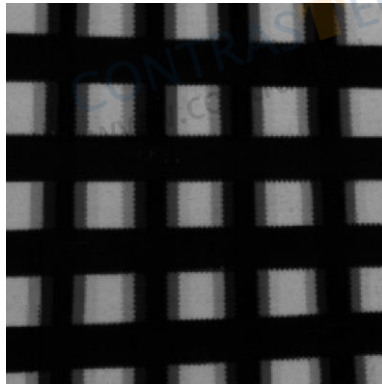
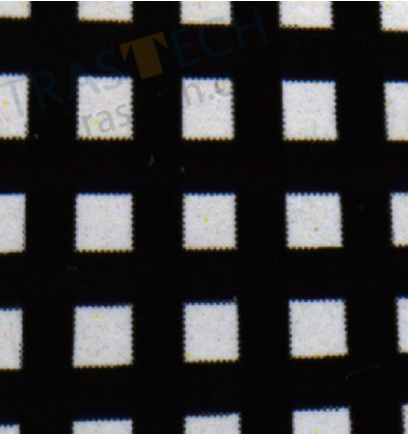
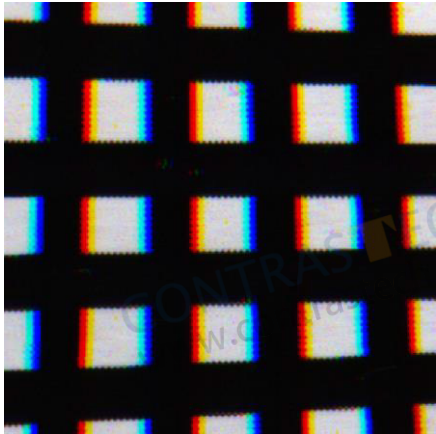
Type	Normal Image	Abnormal Image
Mono		
Color		

- Steps
1. Set Off as Parallax Direction if the image's edge does not have pixel deviation.
 2. Set Parallax Direction according to actual conditions if the image's edge has pixel deviation.
 - For the mono device, if its upper sensor is closer to the measured objects, and select Start Line as Parallax Direction. Otherwise, select End Line instead.
 - For the color device, if its sensor's B line is closer to the measured objects, and select Blue as Parallax Direction. If its sensor's R line is closer to the measured objects, and select Red instead.
 3. Set Pixel Shift to have a best effect.

CHAPTER 9 OTHER FUNCTIONS

Device Control



The specific device control parameters may differ by device models.

In the Device Control attribute, you can view device information, edit device name, reset device, etc. The specific parameters in Device Control attribute are shown below.

Parameter	Read/Write	Description
Device Type	Read only	It is the device type.
Device Scan Type	Read only	It is the scan type of the sensor.
Device Model Name	Read only	It is the device model.
Device Firmware Version	Read only	It is the device firmware version.
Device Serial Number	Read only	It is the device serial number.
Device User ID	Read and write	Device name and it is empty by default. You can set according to your preference. <ul style="list-style-type: none"> ● If User ID is empty, the client software displays the device model. ● If you set it, the client software displays the User ID you set.
Device Uptime(s)	Read only	It is the period of time when device is powered up.
Device Connection Selector	Read and write	It selects which Connection of the device to control.
Device Connection Speed(Mbps)	Read only	It indicates the speed of transmission of the specified connection.
Device Link Selector	Read and write	It selects which Link of the device to control
Device Link Speed(Mbps)	Read only	It indicates the speed of transmission negotiated on the specified link.
Device Link Connection Count	Read only	It returns the number of physical connection of the device used by a particular link.
Device Link Heartbeat Mode	Read and write	It activates or deactivates the link's heartbeat.
Device Stream Channel Type	Read only	It reports the type of the stream channel.
Device Stream Channel Link	Read only	It is the index of device's Link to use for streaming the specified stream channel.
Device Event Channel Count	Read only	It is the endianness of multi-byte pixel data for this stream.
Device Character Set	Read Only	It is character set used by the strings of the device's bootstrap registers.
Device Reset	Read Only	Click Execute to reset the device.
Device Temperature Selector	Read and write	It selects device component to view its temperature. Currently, only sensor can be selected only.
Device Temperature	Read Only	It displays the temperature of selected components in Device Temperature Selector.
Find Me	Read and write	The function of finding me is executed. Click Execute to find the currently operating device.
HB Abnormal Monitor	Read Only	It monitors image stream condition.

Embedded Information in Image

The device supports embedding information into image data. The information will be embedded into the image according to the enabling condition of each type of information in the order of the image embedding information listed in the table below.

i	White Balance is only available for the color devices.	
Information Type	Byte	Data Format Description
Timestamp	4	4 bytes are used to transfer the timestamp information. Refer to figure on the right.
Gain	4	4 bytes are used to transfer the gain information. Each low 8 bits of the 4 valid data are combined to transfer the gain information. Value Range: 0 to 1023. Note: High bits will be complemented with 0 automatically.
Exposure	4	4 bytes are combined to show the exposure time, and the unit is μ s.
Brightness Info	4	Ranges from 0 to 4095
White Balance	8	R/G/B occupies 2 bytes each. Value Range: 0 to 4095.
Frame Counter	4	Value Range: 0 to $2^{32}-1$
Ext Trigger Count	4	Value Range: 0 to $2^{32}-1$
Line Input Output	4	The 1st byte is input, and each bit corresponds to 1 input. The 2nd byte is output, 3rd and 4th bytes are reserved.
Width	4	Value Range: 0 to $2^{32}-1$
Height	4	Value Range: 0 to $2^{32}-1$
Offset X	4	Value Range: 0 to $2^{32}-1$
Offset Y	4	Value Range: 0 to $2^{32}-1$
Pixel Format	4	Value Range: 0 to $2^{32}-1$
ROI Position	8	The starting coordinates occupy two bytes each with the column coordinates at the front and the row coordinates at the back. The length and width coordinates each occupy two bytes.

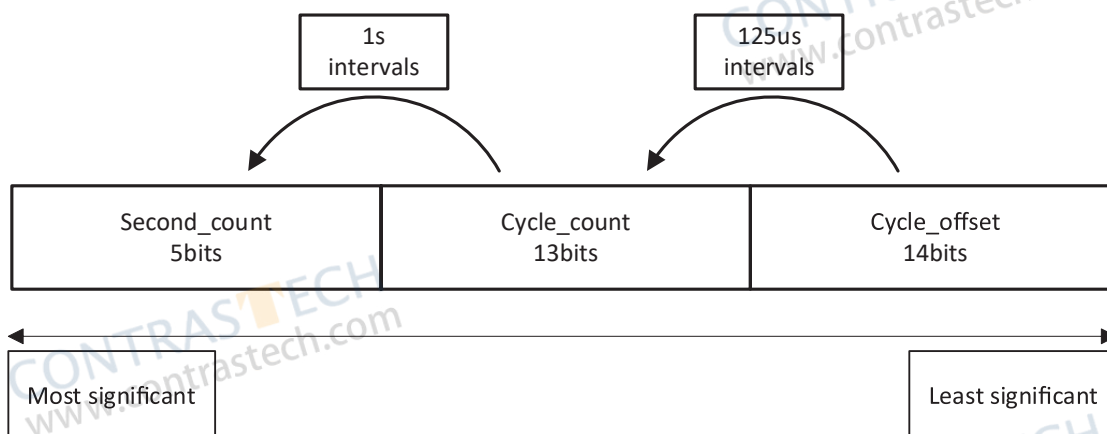

You can embed information into the image via Chunk function.

Steps

1. Go to Chunk Data Control → Chunk Mode Active, and Chunk Mode Active.
2. Select Chunk Selector according to actual demands.
3. Enable Chunk Enable to embed information into the image.
4. (Optional) Repeat steps above to add multiple Chunk information types.
4. Click  on the control toolbar of the client software to view specific information.

Watermark Settings

Steps

1. Go to Image Format Control → Embedded Image Info Selector, and select Embedded Image Info Selector according to actual demands.

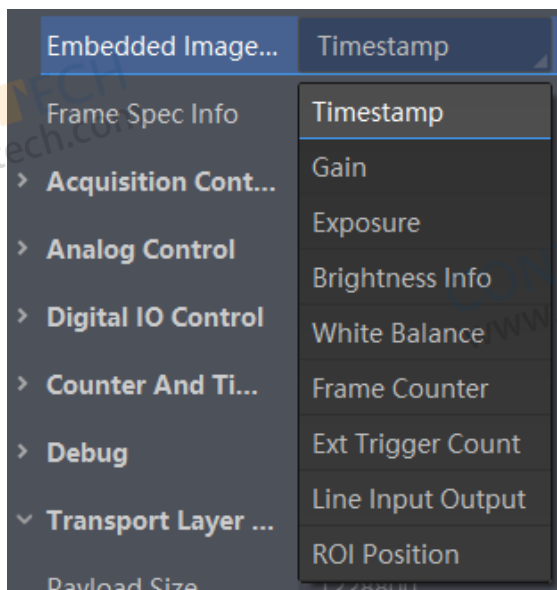

2. Enable Frame Spec Info to add watermark into images.



3. (Optional) Repeat steps above to add multiple watermarks.

4. Click  on the control toolbar of the client software to view specific watermark information.

 The watermark is embedded into the starting position of the first line of image data. If the ROI is small and the first line of image data is insufficient to embed information, the information will be embedded into the second line of image data.

Chunk Settings

Steps

1. Go to Chunk Data Control → Chunk Mode Active, and Chunk Mode Active.

2. Select Chunk Selector according to actual demands.

3. Enable Chunk Enable to embed information into the image.

4. (Optional) Repeat steps above to add multiple Chunk information types.

4. Click  on the control toolbar of the client software to view specific watermark information.

Action Command

- The action command function may differ by device models.
- Only latest version of iDatum client software support GigE Vision action command.

The action command allows you to execute actions on multiple devices at roughly the same time by using a single broadcast protocol message.

Steps

1. Go to Transport Layer Control → GEV IEEE 1588, and enable GEV IEEE 1588.
2. Go to Acquisition Control → Trigger Selector, and select Frame Burst Start.
3. Select On as Trigger Mode.
4. Select Action 1 as Trigger Source.
5. Go to Tool → GigE Vision Action Command in the menu bar.
6. Select Network Interfaces to set the subnet that the command to be sent to.
7. Enter Device Key, Group Key, and Group Mask.

Parameter Name	Device Parameter Name	Description
Device Key	Action Control → Action Device Key	The parameter value should be the same.
Group Key	Action Control → Action Group Key	The parameter value should be the same.
Group Mask	Action Control → Action Group Mask	The bitwise AND operation of the Group Mask against the Action Group Mask feature should results in non-zero.

8. Enable Scheduled.
9. Click in Benchmark Camera to select one device as benchmark device. Once benchmark device is selected, other devices keep time synchronization with it.
10. (Optional) Enter Delay Time according to actual demands.

- The delay time is 20 ns by default.
- When the benchmark device receives the command, all devices will trigger certain actions simultaneously after the specified delay time.

11. (Optional) Enable Periodically Send to enable the client to send commands periodically, and enter Sending Interval according to actual demands.

The default value of sending interval is 1000 ms, and its range is from 1 ms to 3600000 ms.

12. (Optional) Enable Request Acknowledgement to display the acknowledgement messages.
13. Click Start Sending.

Transport Layer Control

You can go to Transport Layer Control to view the device's payload size, GEV version, etc.

 The specific parameters of transport layer control may differ by device models.

Parameter	Read/Write	Description
Paylode Size	Read only	It is the camera's load size.
Streaming Mode	Read and write	It is the network transmission mode. <ul style="list-style-type: none"> ● Quick Frame Mode: After the device acquires a data package, the package will be transferred to the PC via network immediately, and acquisition speed improves. ● Standard Mode: After the device acquires a complete frame, the image will be transferred to the PC via network.
GEV Interface Selector	Read only	It sets which physical network interface to be controlled.
GEV MAC Address	Read only	It is the MAC address of the network interface.
GEV Current IP Configuration LLA	Read only	It indicates whether the Link Local Address IP configuration scheme is activated on the given network interface.
GEV Current IP Configuration DHCP	Read and write	It indicates whether the DHCP IP configuration scheme is activated on the given network interface.
GEV Current IP Configuration Persistent IP	Read and write	It indicates whether persistent IP configuration scheme is activated on the given network interface.
DEV PAUSE Frame Reception	Read and write	It controls whether incoming pause frames are handled on the given logical link.
GEV Current IP Address	Read only	It is the current IP address for the given network interface.
GEV Current Subnet Mask	Read only	It is the current subnet mask of the given interface.
GEV Current Default Gateway	Read only	It is the default gateway IP address to be used on the given network interface.
GEV Number Of Interfaces	Read only	It indicates the number of physical network interfaces supported by this device.
GEV Persistent IP Address	Read and write	It indicates the persistent IP address for this network interface. It is only used when the device boots with the persistent IP configuration scheme.
GEV Persistent Subnet Mask	Read and write	It indicates the persistent subnet mask associated with the persistent IP address on this network interface. It is only used when the device boots with the persistent IP configuration scheme.
GEV Persistent Default Gateway	Read and write	It indicates the persistent default gateway for this network interface. It is only used when the device boots with the persistent IP configuration scheme.
GEV Link Speed	Read only	It indicates the speed of transmission negotiated by the given network interface in Mbps.
GEV Message Channel Count	Read only	It indicates the number of message channels supported by this device.
GEV Stream Channel Count	Read only	It indicates the number of stream channels supported by this device.
GEV Heartbeat Timeout(ms)	Read and write	It indicates the current heartbeat timeout in milliseconds.
GEV Heartbeat Disable	Read and write	It disables the GEV Heartbeat.
GEV Timestamp Tick Frequency (Hz)	Read only	It indicates the number of timestamp ticks in 1 second (frequency in Hz).
Timestamp Control Latch	Read and write	It latches the current timestamp value of the device.
Timestamp Control Reset	Read and write	It resets the timestamp value for the device.
Timestamp Control Latch Reset	Read and write	It resets the timestamp control latch.
Timestamp Value	Read only	It is a read only element. It indicates the latched value of the timestamp.
GEV CCP	Read and write	It controls the device access privilege of an application.
GEV MCP Host Port	Read and write	It controls the port to which the device must send messages. Setting this value to 0 closes the message channel.
GEV MCDA	Read and write	It indicates the target IP address for setting up the message channel.
GEV MCTT(ms)	Read and write	It indicates the data transmission timeout, with the unit being milliseconds.
GEV MCRC	Read and write	It controls the number of retransmissions allowed when a message channel message times out.

Transport Layer Control

Parameter	Read/Write	Description
GEV MCSP	Read only	It indicates the source port for the message channel.
GEV Stream Channel Selector	Read only	It selects the stream channel to control.
GEV SCP Interface Index	Read only	It is the Index of network interface to be used.
GEV SCP Host Port	Read and write	It is the host port of the channel
GEV SCP Direction	Read only	It transmits or receives the channel.
GEV SCPS Fire Test Packet	Read only	It sends a test packet.
GEV SCPS Do Not Fragment	Read and write	The state of this feature is copied into the "do not fragment" bit of the IP header of each stream packet.
GEV SCPS Big Endian	Read only	It is the Endianness of multi-byte pixel data for this stream.
GEV SCPS Packet Size(B)	Read and write	It specifies the stream packet size (in bytes) to send on this channel.
Auto SCPD	Read and write	After it is enabled, the SCPD value will be adjusted automatically.
GEV SCPD	Read and write	It indicates the delay (in timestamp counter units) to insert between each packet for this stream channel.
GEV SCDA	Read and write	It indicates the destination IP address for this stream channel.
GEV SCSP	Read only	It indicates the source UDP port address for this stream channel.
GEV IEEE 1588	Read and write	It enables the IEEE 1588 Precision Time Protocol to control the timestamp register.
GEV IEEE 1588 Slave Only	Read and write	After enabling, the device serves as a sub device in IEEE 1588 mode.
GEV GVSP Extended ID Mode	Read and write	It enables the extended ID mode.

Transfer Control

You can go to the Transfer Control attribute to view the camera's transfer sources, transfer mode, queue information, etc.

	The specific parameters of transfer control may differ by device models.
--	--

Parameter	Description
Transfer Selector	It selects the transfer source.
Transfer Control Selector	It selects the transfer mode.
Transfer Queue Max Block Count	It displays the max. image quantity that the camera memory can save before the compression.
Transfer Queue Current Block Count	It displays the current saved image quantity. When the quantity is smaller than 1 GB, it displays 0 or 1.
Transfer Queue Over Flow Count	It is the image quantity discarded by FPGA.
Transfer Queue Mode	It is the operating mode of memory queue.

Event Control

The event control can record events happen to the device and allow you to view them.

Steps

1. Go to Event Control → Event Selector, and select Event Selector according to actual demands.
2. Select Notification On as Event Notification to output event.
3. Right click the connected device and click Event Monitor.
4. Check Messaging Channel Event, and view the specific event after the device starts live view.

	The event control function may differ by camera models.
--	---

File Access Control

	The file access control function may differ by device model.
--	--

The file access function can import or export the device's feature files and save them in mfa format. The supported feature files include User Set 1/2/3, LUT Luminance 1/2/3, USER PRNUC 1/2/3, and USER FPNC 1/2/3.

Steps:

1. Select the camera in the device list. Click  to open the File Access interface.



2. Select Device Feature and click Import or Export.
3. Select a mfa file from local PC to import or select a saving path and enter file name to save and export.

	<ul style="list-style-type: none"> ● If User Set 1/2/3 is selected as device feature, you need to load the corresponding user set you selected to take effect. ● If LUT Luminance 1/2/3 is selected as device feature, and they will take effect only when you select the same parameters in LUT Selector. ● USER PRNUC 1/2/3 has the same mechanism with LUT Luminance 1/2/3 mentioned above. ● If USER FPNC 1/2/3 is selected as device feature, and they will take effect immediately when FPNC User Enable is enabled. ● Importing and exporting the device feature among the same model of devices are supported. ● License Notice supports exporting only.
--	--

Multicast

The multicast function enables multiple PCs to access the same device at the same time.

At the same time, the same device can only be connected by one client in controller and data receiver mode or controller mode, but can be connected by multiple clients in data receiver mode. The multicast mode of each device within the client is controlled individually. The description of three multicast modes is shown below.

Modes	Description
Controller and Data Receiver	This mode allows you to read and edit the camera's parameters, and get its image data.
Controller	This mode allows you to read and edit the camera's parameters, but you cannot get its image data.
Data Receiver	This mode allows you read the camera's parameters and get its image data, but you cannot edit the camera's parameters.

When the multicast function is enabled, the camera icon on the iDatum of other PCs will become , and you can connect the camera via the data receiver mode.

When you connect the camera via the data receiver mode, the camera icon on the iDatum of your PC will become , and at this time, you can read its parameters only.

You can set multicast function for both the available camera and connected camera, but the specific settings are different.

■ Enable Multicast (Available)

For the available camera, you can set multicast function as follows.

1. Right click the available camera, and click Multicast Settings.
2. Select Role, and enter the IP Address and Port.
3. Click OK.



- The available status device can use multicast function in Controller and Data Receiver mode or Controller mode.
- The IP address should be class D IP address, and the port ranges from 0 to 65535.

■ Enable Multicast (Connected)

Follow steps below to set multicast function if the device is in connected status.

Steps

1. Right click the available device, and click Multicast Settings.
2. Enable the multicast function, and edit the IP Address and Port.
3. Click OK.



- The connected status device can use multicast function in Controller and Data Receiver mode only.
- The IP address should be class D IP address, and the port ranges from 0 to 65535.

Save and Load User Set

The camera supports 4 sets of parameters, including 1 default set and 3 user sets. You can save parameters, load parameters and set user default as shown below.

_Save Parameters:

1. Click User Set Control, and select a user set in User Set Selector. Here we take selecting User Set 1 as an example.
2. Click Execute in User Set Save to save parameters.

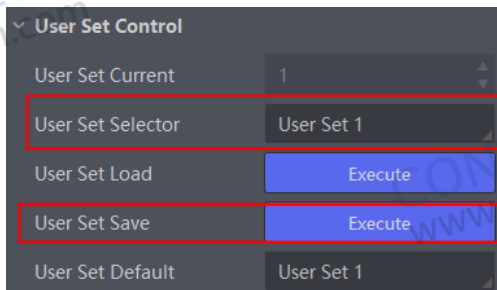

_Load Parameters:

1. Click User Set Control, and select a user set in User Set Selector. Here we take selecting User Set 1 as an example.
2. Click Execute in User Set Load to load parameters to the camera, as shown below.

i Loading parameters is available when connecting with camera, but without acquisition.

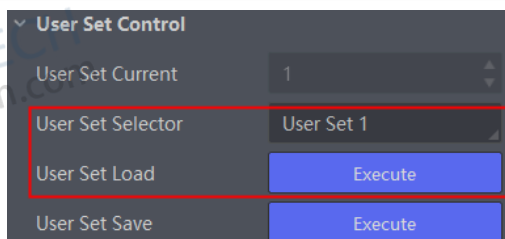

_Set User Default:

You can also set default parameter by selecting parameter from drop-down list of User Set Default.

Camera Parameter Index

Attribute	Parameter	Section
Device Control	Device Type	Device Control
	Device Scan Type	
	Device Vendor Name	
	Device Model Name	
	Device Manufacturer Info	
	Device Version	
	Device Firmware Version	
	Device Serial Number	
	Device ID	
	Device User ID	
	Device Uptime	
	Board Device Type	
	Device Connection Selector	
	Device Connection Speed	
	Device Link Selector	
	Device Link Speed	
	Device Link Connection Count	
	Device Link Heartbeat Mode	
	Device Stream Channel Count	
	Device Stream Channel Selector	
	Device Stream Channel Type	
	Device Stream Channel Link	
	Device Stream Channel Endianness	
	Device Stream Channel Packet Size	
	Device Event Channel Count	
	Device Character Set	
	Device Reset	
	Device Temperature Selector	
	Device Temperature	
	Find Me	
Device Max Throughput		
Device PJ Number		
HB Abnormal Monitor		
HB Version		

Camera Parameter Index

Attribute	Parameter	Section
Image Format Control	Width Max	Resolution and ROI
	Height Max	
	Region Selector	
	Region Destination	
	Width	
	Height	
	Offset X	
	Offset Y	
	Reverse X	Image Reverse
	Pixel Format	Pixel Format
	Pixel Size	
	Image Compression Mode	Test Pattern
	Test Pattern Generator Selector	
	Test Pattern	
	Binning Selector	Binning
	Binning Horizontal	
	Binning Vertical	
	Direction Source	Scan Direction
	Reverse Scan Direction	
	Embedded Image Info Selector	Embed Information into Image
Frame Spec Info		
TDI Mode	TDI Function	
Acquisition Control	Acquisition Mode	Line Rate
	Acquisition Stop	
	Acquisition Burst Frame Count	
	Acquisition Line Rate	
	Acquisition Line Rate Control Enable	
	Resulting Line Rate	
	Reference Line Rate	
	Resulting Frame Rate	
	Trigger Selector	Trigger Input
	Trigger Mode	
	Trigger Source	
	Trigger Activation	
	Trigger Partial Close	
	Line Delay Enable	
	Trigger Delay	
Trigger Cache Enable		
Line Trigger Cache Enable		

Camera Parameter Index

Attribute	Parameter	Section
Acquisition Control	Exposure Mode	Exposure Mode
	Exposure Time(us)	
	Exposure Auto	
	Auto Exposure Time Lower Limit(us)	
	Auto Exposure Time Upper Limit(us)	
	Frame Timeout Enable	Frame Timeout
	Frame Timeout Time(ms)	
	Partial Frame Discard	
	Abnormal Line Enable	Abnormal Line Function
Advanced Processing	Preamp Gain	Gain
	Gain	
	Sensor Mode	Sensor Mode
	Gain Auto	Analog Gain
	Auto Gain Lower Limit	
	Auto Gain Upper Limit	
	ADC Gain x 4 Enable	
	Digital Shift	Digital Gain
	Digital Shift Enable	
	Black Level	Black Level
	Black Level Enable	
	Balance White Auto	White Balance
	AWB Color Temperature Mode	
	Balance Ratio Selector	
	Balance Ratio	
	Gamma	Gamma Correction
	Gamma Selector	
	Gamma Enable	
	Auto Function AOI Selector	AOI
	Auto Function AOI Width	
Auto Function AOI Height		
Auto Function AOI Offset X		
Auto Function AOI Offset Y		
Auto Function AOI Usage Intensity		
Auto Function AOI Usage White Balance		

Camera Parameter Index

Attribute	Parameter	Section
Color Transformation Control	CCM Enable	Color Transformation Control
	Color Transformation Selector	
	Color Transformation Enable	
	Color Transformation Value Selector	
	Color Transformation Value	
	Hue	Hue
	Hue Enable	Saturation
	Saturation	
	Saturation Enable	
	Color Adjustment Enable	Color Adjustment
	Color Adjustment Selector	
	Color Adjustment Hue	
Color Adjustment Saturation		
LUT Control	LUT Selector	LUT
	LUT Enable	
	LUT Index	
	LUT Value	
	LUT Save	
Encoder Control	Encoder Selector	Shaft Encoder Control
	Encoder Source A	
	Encoder Source B	
	Encoder Trigger Mode	
	Encoder Counter Mode	
	Encoder Counter	
	Encoder Counter Max	
	Encoder Counter Reset	
	Encoder Max Reverse Counter	
	Encoder Reverse Counter Reset	
Frequency Converter Control	Input Source	Frequency Converter Control
	Signal Alignment	
	Trigger Line Rate(Hz)	
	PreDivider	
	Multiplier	
	PostDivider	
	Resulting Trigger Line Rate(Hz)	

Camera Parameter Index

Attribute	Parameter	Section
Shading Correction	Shading Selector	Shading Correction
	Activate Shading	
	NUC Enable	
	PRNUC Enable	
	PRNUC ROI Enable	
	PRNUC ROI Extension Enable	
	User Flat Field Correction	
	PRNUC Width	
	PRNUC Offset X	
	FPNC User Enable	
	FPNC User Selector	
	PRNUC User Enable	
	PRNUC User Selector	
	PRNUC Target Enable	
	PRNUC Target	
	PRNUC Target R	
	PRNUC Target G	
	PRNUC Target B	
	PRNUC Smooth Enable	Flat Field Correction
	Flat Field Correction Tool	Space Correction
Line Rate Ratio		
Pixel Shift		
Parallax Direction	Color Abnormal Correction	
CAC Enable		
CAC Edge Threshold		
I/O Control	Line Selector	Trigger Output
	Line Mode	
	Line Format	
	Line Status	
	Line Status All	
	Line Debouncer Time	
	Line Inverter	
	Line Source	
	Strobe Enable	
	Strobe Source Selector	
	Strobe Line Duration	
	Strobe Line Delay	
	Strobe Line Pre Delay	

Camera Parameter Index

Attribute	Parameter	Section
Action Control	Action Device Key	Action Control
	Action Queue Size	
	Action Selector	
	Action Group Mask	
	Action Group Key	
Counter And Timer Control	Counter Selector	Enable Strobe Signal
	Counter Event Source	
	Counter Reset Source	
	Counter Reset	
	Counter Value	
	Counter Current Value	
File Access Control	File Selector	File Access Control
	File Operation Selector	
	File Operation Excute	
	File Open Mode	
	File Operation Status	
	File Operation Result	
	File Size(B)	
Event Control	Event Selector	Event Control
	Event Notification	
Chunk Data Control	Chunk Mode Active	Chunk Data Control
	Chunk Selector	
	Chunk Enable	

Camera Parameter Index

Attribute	Parameter	Section
Transport Layer Control	Payload Size(B)	Transport Layer Control
	Streaming Mode	
	Fast Collect Slow Trans Mode	
	GEV Version Major	
	GEV Version Minor	
	GEV Device Mode Is Big Endian	
	GEV Device Mode Character Set	
	GEV Interface Selector	
	GEV MAC Address	
	GEV Supported Option Selector	
	GEV Supported Option	
	GEV Current IP Configuration LLA	
	GEV Current IP Configuration DHCP	
	GEV Current IP Configuration Persistent IP	
	GEV PAUSE Frame Reception	
	GEV Current IP Address	
	GEV Current Subnet Mask	
	GEV Current Default Gateway	
	GEV First URL	
	GEV Second URL	
	Dictionary URL	
	GEV Number Of Interfaces	
	GEV Persistent IP Address	
	GEV Persistent Subnet Mask	
	GEV Persistent Default Gateway	
	GEV Link Speed	
	GEV Message Channel Count	
	GEV Stream Channel Count	
	GEV Heartbeat Timeout	
	GEV Heartbeat Disable	
	GEV Timestamp Tick Frequency	
	Timestamp Control Latch	
	Timestamp Control Reset	
	Timestamp Control Latch Reset	
Timestamp Value		
GEV CCP		
GEV MCP Host Port		
GEV MCDA		
GEV MCTT		
GEV MCRC		

Camera Parameter Index

Attribute	Parameter	Section
Transport Layer Control	GEV MCSP	Transport Layer Control
	GEV Stream Channel Selector	
	GEV SCP Interface Index	
	GEV SCP Host Port	
	GEV SCP Direction	
	GEV SCPS Fire Test Packet	
	GEV SCPS Do Not Fragment	
	GEV SCPS Big Endian	
	GEV SCPS Packet Size(B)	
	GEV SCPD	
	GEV SCDA	
	GEV SCSP	
	Gev IEEE 1588	
	Gev IEEE 1588 Slave Only	
	GEV IEEE 1588 Status	
Gev GVSP Extended ID Mode		
Transport Control	Transfer Selector	Transport Control
	Transfer Control Selector	
	Transfer Queue Max Block Count	
	Transfer Queue Current Block Count	
	Transfer Queue Over Flow Count	
	Transfer Queue Mode	
User Set Control	User Set Current	User Set Control
	User Set Selector	
	User Set Load	
	User Set Save	
	User Set Default	

Trouble Shooting

Trouble:

■ No camera found when running the iDatum

Possible Reason1: Camera is not started up normally

Solution1: Check camera power wiring (observe the indicator)

Possible Reason2: Network cable connection error

Solution2: Check network connection

■ Camera connection error

Possible Reason1: Camera and client software are not in the same network segment

Solution1: Edit its IP address

Possible Reason2: The camera has been connected by another program

Solution2: Reconnect after disconnecting the camera from other programs

■ Live view is black

Possible Reason1: Aperture is closed

Solution1: Open the aperture

Possible Reason2: Camera exception occurs

Solution2: Reboot the camera.

■ Live view is normal, but the camera cannot be triggered.

Possible Reason1: Trigger mode is not enabled

Solution1: Check whether the camera trigger mode and related trigger signal input are normal in the current environment.

Possible Reason2: Incorrect wiring

Solution2: Check whether the wiring is correct under corresponding triggering mode.

■ Why Strobe cannot be set as Line Mode?

Possible Reason: The Line * is selected as the trigger source among FrameTrigger/LineTrigger/Shaft Encoder Control/Frequency Converter Control.

Solution: Select Line * in all modes (FrameTrigger/LineTrigger/Shaft Encoder Control/Frequency Converter Control), and then you can set Strobe as Line Mode.

CHAPTER 10 TECHNICAL SUPPORT

If you need advice about your camera or if you need assistance troubleshooting a problem with your camera, it's highly recommended to describe your issue in details and contact us via E-mail at support@contrasttech.com

It would be helpful if you can fill-in the following table and send to us before you contact our technical support team.

Camera Model:		Camera's SN:	
Describe the issue in as much detail as possible:			
If known, what's the cause of the issue?			
How often did/does the issue occur?			
How severe is the issue?			
Parameter set	Please connect the camera directly to PC and use iDatum to make note of the parameter when the issue occurred.		

Hangzhou Contrastech Co., Ltd

No.8 Xiyuan 9th Road, West Lake District Hangzhou Zhejiang 310030 China
Tel: +86 571-89712238
www.contrastech.com