

# Industrial Code Reader User Manual DM-J

V2.3.8, Aug. 2023

---

## Preface

### Purpose

---

This Manual is a basic description of industrial code reader, which mainly includes the product description, quick installation guide and Simple introduction of SDK(DM-Datum). This manual may be updated due to product upgrades or other reasons. If you need, please contact the sales engineer for the latest version of this manual.

---

Copyright ©2023  
Hangzhou Contrastech Co., Ltd.  
Tel.: +86 571-89712238  
Add.:No. 8 Xiyuan 9th Road, West Lake District Hangzhou Zhejiang 310030 China.

All rights reserved. The information contained herein is proprietary and is provided solely for the purpose of allowing customers to operate and/or service Contrastech manufactured equipment and is not to be released, reproduced, or used for any other purpose without written permission of Contrastech.

### Disclaimer

The information and specifications described in this manual are subject to change without notice.

### Latest Manual Version

For the latest version of this manual, see the Download Center on our web site at: <https://www.contrastech.com/en/service/005001.html>

### Technical Support

For technical support, e-mail: [support@contrastech.com](mailto:support@contrastech.com).

### Warranty

To ensure that your warranty remains in force, adhere to the following guidelines:

**Do not remove the camera's serial number label**

If the label is removed and the serial number can't be read from the camera's registers, the warranty is void.

**Do not open the camera housing**

Do not open the housing. Touching internal components may damage them.

**Prevent ingress or insertion of foreign substances into the camera housing**

Prevent liquid, flammable, or metallic substances from entering the camera housing. If operated with any foreign substances inside, the camera may fail or cause a fire.

**Avoid electromagnetic fields**

Do not operate the camera in the vicinity of strong electromagnetic fields. Avoid electrostatic charging.

**Clean with care**

Avoid cleaning the sensor if possible.

**Handle this camera with care**

Do not abuse the camera. Avoid striking, shaking, etc. The camera could be damaged by improper handling.

**Read the manual**

Read the manual carefully before using the camera.

# PRODUCT DESCRIPTION

## Product Introduction

The code reader mentioned in this manual integrates image acquisition, bar code recognition and output functions, can efficiently read 1D codes and 2D codes in a variety of code systems, and has a compact and compact structure, suitable for 3C, food and medicine, electronic semiconductors, new energy and other industries.

The device uses sensors and optical components to obtain images of the measured object, and realizes barcode analysis through the built-in deep learning code reading algorithm of the device. The device can also output inspection results through a variety of communication methods.

## Product Features

- Adopts built-in deep learning algorithm to read codes with good robustness.
- Adopts CMOS sensor to acquire image data and provide high-quality image.
- A single cable provides multiple IO interfaces for input and output signals.
- Supports top and double side indicators displaying device status.
- Adopts external waterproof debugging button, support external manual trigger
- Modular light source design, which is easy to switch
- IP67 protection, can be widely used in various industrial scenarios.

\* For technical parameters, please refer to the technical specifications of the model..

\* The camera functions may differ by camera models, please refer to actual functions.

## Status LED Description

Status LED	Description
OK/NG Indicator	It indicates code reading result. <ul style="list-style-type: none"> <li>● The indicator is orange when the device is starting up.</li> <li>● The indicator is red after the device is powered on.</li> <li>● The indicator is flashing green after the device reads barcodes, and it is solid green if the device reads barcodes continuously.</li> </ul>
Device Status Indicator	STS Indicator, The indicator is green when the device operates normally. When the device starts up or exception occurs, it is red.
Power Indicator	PWR Indicator, The indicator is green when the device operates normally. Otherwise, it is red.

## Mechanical Dimensions

The dimensions is in millimeters:

The code reader are secured via M4 size screw located on the back of the housing.  
The 17-pin M12 interface provides power, input/output, Ethernet, and serial port signal, and the threaded interface reduces loosening caused by vibrations.

Camera Housing and Base Mounting Hole Size(mm):

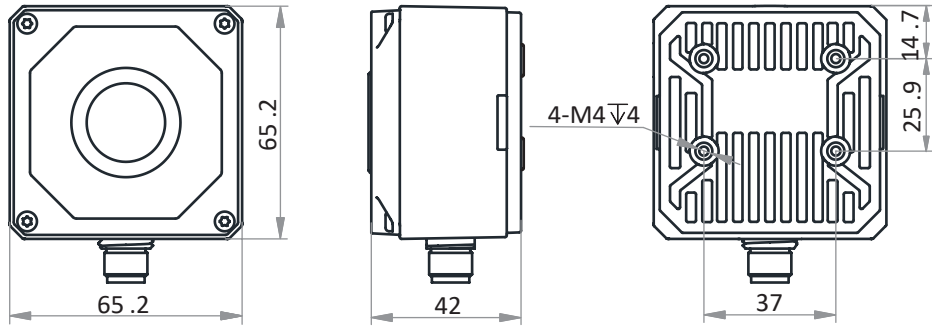

Fig. 1-1: Mechanical Dimensions (in mm) of the Four-way light source code reader with 65.2 \* 65.2 \* 42 mm housing (Built-in 8 LED lamps).

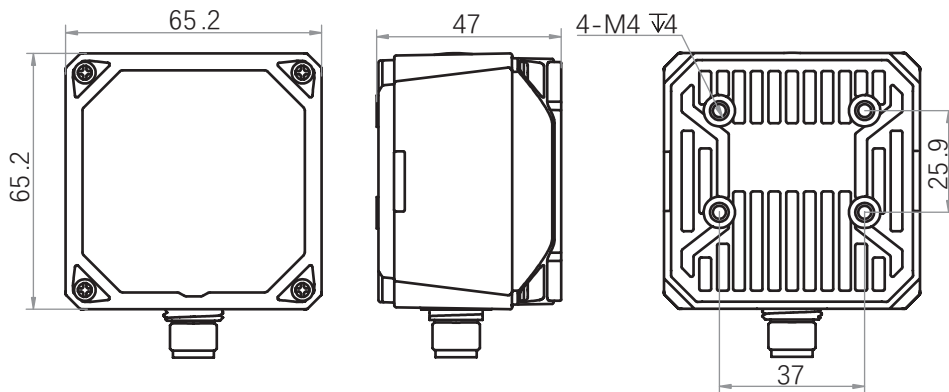

Fig. 1-2: Mechanical Dimensions (in mm) of the Six-way light source code reader with 65.2 \* 65.2 \* 47 mm housing (Built-in 14 LED lamps).

### ■ Focus Knob

It is used to adjust focal length manually.



The focus knob may differ by device models, and some models do not have a focus knob.

### ■ Lens Cap

It can be replaced with other lens cap. Refer to the device's specification for details.

### ■ Light Source

It refers to LED lamps providing light for improving code reading effect.

- The default color of LED lamps is white. Red, blue and IR are optional.
- The quantity of LED lamps may differ by device models.

### ■ Button

\_When the device is in continuous acquisition mode, press the button and the device enters trigger mode.

\_When the device is in trigger mode, press the button and the device triggers once.

## CHAPTER 2

POWER AND  
I/O INTERFACE DEFINITION

## I/O Connection Definition and Assignments

It provides power, input/output, Ethernet, and serial port signal. Read the followings to get pin definitions. Refer to the pin definitions and labels attached to the cable to wire the device.

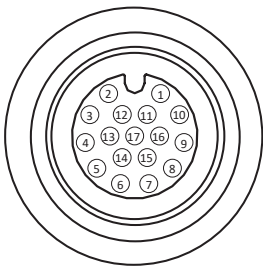

17-pin M12 Connector:

Color	Pin	Signal	Signal Source	Designation
Red	1	POWER_IN	-	Direct current power supply positive
Brown	2	DO_5	LineOut5 signal line	Non-isolated Output
Purple White	3	-	-	-
Green	4	RS-232 TX	-	RS-232 serial port output
Green White	5	RS-232 RX	-	RS-232 serial port input
Yellow	6	MDI0+	-	Fast Ethernet signal MDI0+
Brown White	7	MDI1-	-	Fast Ethernet signal MDI1-
Blue White	8	DO_3	LineOut3 signal line	Non-isolated Output
Blue	9	DI_2	LineIn2 signal line	Non-isolated Input
Brown White	10	DO_4	LineOut4 signal line	Non-isolated Output
Black	11	GND	Signal ground	Direct current power supply negative
Pink	12	-	-	-
Purple	13	-	-	-
Yellow White	14	MDI0-	-	Fast Ethernet signal MDI0-
Orange	15	MDI1+	-	Fast Ethernet signal MDI1+
Gray	16	DI_0	LineIn0 signal line	Non-isolated Input
White	17	DI_1	LineIn1 signal line	Non-isolated Input



- You should refer to the table above and the label attached to the supplied 17-pin cable to wire the device.
- Some devices due to different firmware versions may have output signal source of LineOut0/1/2. Refer to the device you purchased for actual conditions.
- The 12th pin of some devices is input signal connecting pull-up and pull-down resistor, and you should wire the device accordingly.

The wire color of this user manual is the color of ContrasTech. If you use other manufacturers' cable color definitions may be different, random connection may cause the camera to burn out, please connect according to the I/O port type and pin definition or contact our technical staff for advise.

## I/O Connection Definition and Assignments

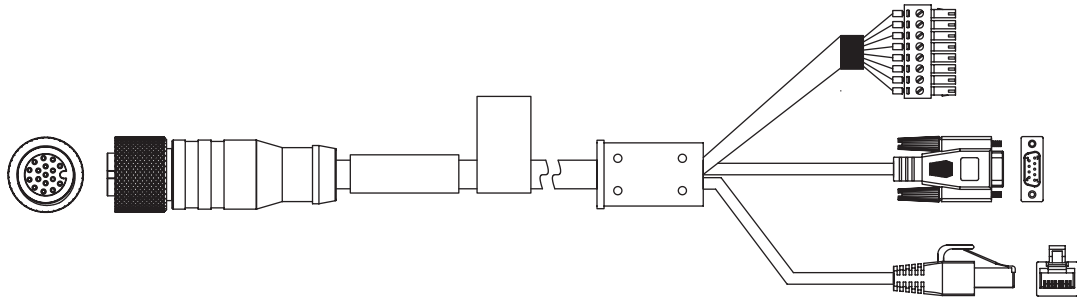

\* The 6th, 7th, 14th, and 15th pin of the interface in the 17-pin cable have been made as RJ45 connector. The lines of other pins should be wired according to the actual demands.

\* The RS-232 serial port part corresponding to the interface pin 4 and 5 in the 17-pin cable has been made into a DB9 female serial port.

The DB9 female serial port comes with a 12V power port, which can power the device just like the 8-pin terminal power supply. When supplying power to the device, only one of them can be used, otherwise the power supply may be burned.

\* The other pins in the 17-pin cable have been made into 8-pin terminals, as shown in the figure below. The signal definition of each pin is shown in the following table, and the corresponding IO interface can be wired according to the actual use needs.

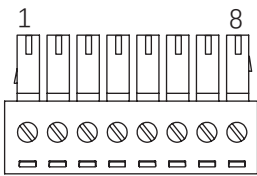

Color	Pin	Signal	Designation
Brown	1	DO_5	Non-isolated Output
Brown White	2	DO_4	Non-isolated Output
Blue White	3	DO_3	Non-isolated Output
Blue	4	DI_2	Non-isolated Input
White	5	DI_1	Non-isolated Input
Gray	6	DI_0	Non-isolated Input
Black	7	GND	Direct current power supply negative
Red	8	POWER_IN	Direct current power supply positive



The 17-pin cable supplied with the factory varies depending on the type of equipment, please refer to the actual situation.

The wire color of this user manual is the color of ConrasTech. If you use other manufacturers' cable color definitions may be different, random connection may cause the camera to burn out, please connect according to the I/O port type and pin definition or contact our technical staff for advise.

## CHAPTER 3 INSTALLATION AND SETUP

You should perform the software installation procedure first and the hardware installation procedure second.

### Software Installation

#### ■ DM-Datum Installation

If you use a firewall on your computer, disable the firewall for the network adapter to which your camera is connected.

##### Close the Firewall

In order to ensure the camera software keep running and image transmission stability, please close the firewall before using the software.

##### System Requirements

Code Reader Software Suite for Windows requirements that one of the following operating systems is installed on your computer:

- Windows XP (32 bit)
- Windows 7 (32 bit or 64 bit)
- Windows 10 (32 bit or 64 bit)

##### Installation Steps

- 1.You can download the software from:  
<http://www.contrastech.com/en/service/005001.html>
- 2.Double click DM-Datum installation package to install the client.
- 3.Follow the instructions on the screen. The installer will guide you through the installation process.

##### Network Settings

Before using the camera, you need to configure IP is in the same network segment with the computer. You can modify it in "Local Connection" to ensure network communication is normal.

Local Network Configuration :

- Click "Control Panel"> "Network and Internet"> "Network and Sharing Center"> "Change Adapter Configuration. "Then select corresponding network card to configure it automatically obtain IP address or manually assign it as same network segment address with the camera. Shown as below:



## Hardware Installation

1. Install the equipment to the fixed bracket with M4 screws, and then install it on other mechanical parts through the fixing bracket, and the installation method can be selected according to the actual application scenario.
2. Refer to the interface definition in the POWER AND I/O IENTERFACE DEFINITION section for wiring, and connect it to the appropriate power adapter or switching power supply to power the device.
3. Use the network cable to connect the device to the switch or network card normally for image debugging or data communication.

## Software Operation

### DM-Datum Operation

Double-click the DM-Datum shortcut on the desktop to open up the client software, the client software can read the device information and display it.

### Main interface

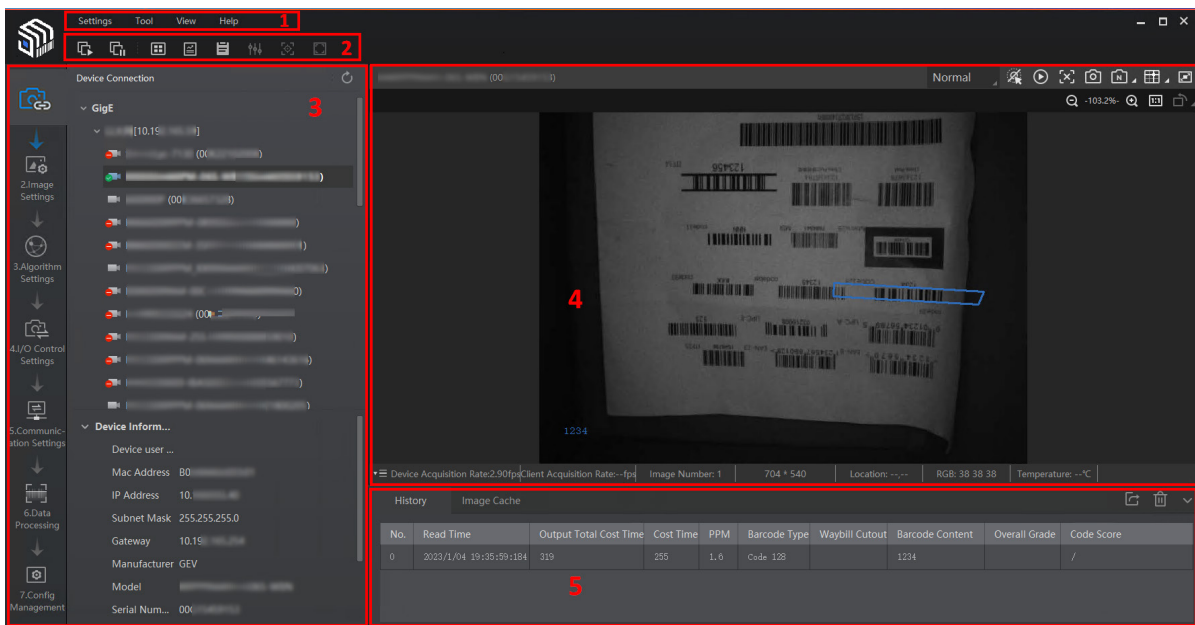

### Menu Bar

The menu bar displays function modules, including Settings, Tool, View, and Help.

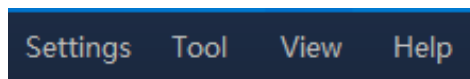

### Control Toolbar

The control toolbar provides quick operations for the device. You can click different icons to start or stop batch acquisition, change window layout, view statistics information, and device log.



### Device Configuration Area

You can connect or disconnect device, set parameters, and modify device IP address in this area.

### Live View Window

This area displays the acquisition images and algorithm reading result in real-time. You can click different icons to capture and save image, record, etc.

### History Record and Image Cache

This area displays different barcode information read by the device in real-time, including read time, cost time, code type, content, code score, etc. You can also set image cache here.



## Software Operation

The device supports 3 types of operating modes, including Test, Normal, and Raw. You can select different modes in live view window according to actual demands.

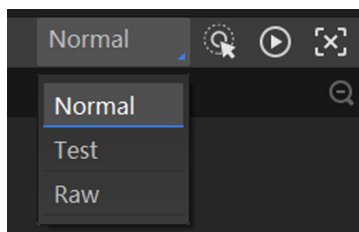

You can set device parameters in device configuration area.

No.	Module Name	Description
1	Device Connection	You can connect or disconnect device, modify device IP address, view device information, etc.
2	Image Settings	You can set image parameters, light parameters, etc.
3	Algorithm Settings	You can add different barcodes, set barcode number, etc.
4	I/O Control Settings	You can set parameters related with input and output.
5	Data Processing	You can set filter rule for output result.
6	Communication Settings	You can select different communication protocols, and set related parameters for output result.
7	Configuration Management	You can save and load user parameters, and restart the device.

You can click  in the live view window to view images and the code reading effect. For the code read in real time, the client will frame the code in the real-time screen and display the specific code information on the left side, as shown in the following figure.

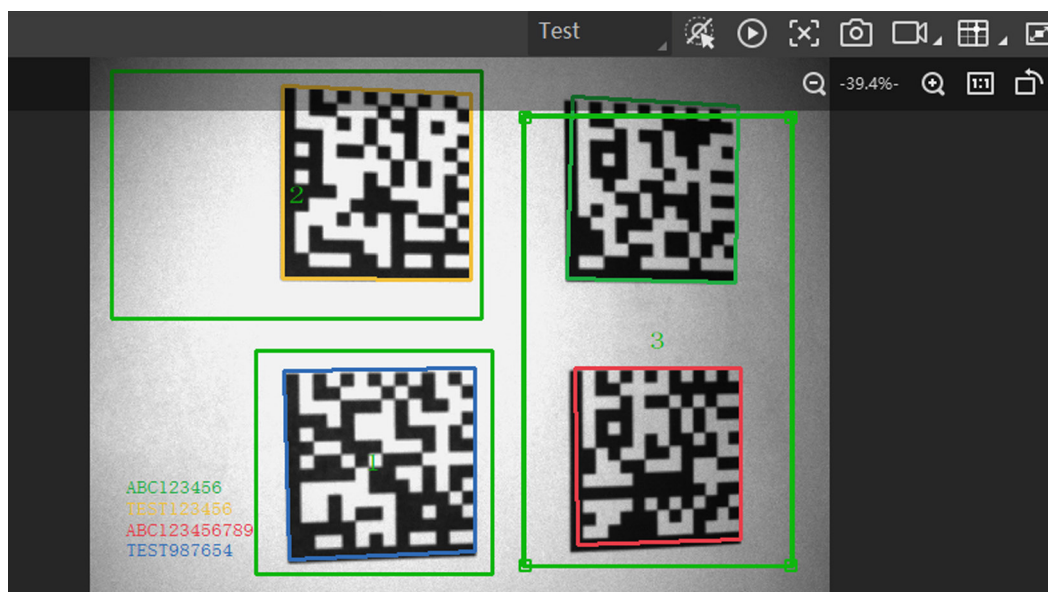

If the effect is not very good, you can adjust the focus knob (the manual focus device only) or related parameters in Image Settings area. Includes exposure time, gain, gamma, and light source parameters. At the same time, for manual focusing equipment, the focus knob on the side of the device can be manually adjusted; For devices with mechanical focus lenses, the image effect can be adjusted through the autofocus function.



- For equipment without light source, it is necessary to fill the light through an external light source.
- For different firmware versions or models of device, the light source functions may be different, please refer to the actual one you got.

## CHAPTER 4 DEVICE SETTINGS

You are recommended to complete device settings in following order: Device Connection → Image Settings → Algorithm Settings → I/O Control Settings → Data Processing → Communication Settings → Configuration Management.



Before specific device settings, you need to set device mode as Normal. Otherwise, the device parameters may be different. Regarding device mode, refer to Device Mode Settings for details.

- **Device Connection:** It tells you how to connect the device to the client software. And you can configure and operate the device remotely via the client software only when you have connected the device to the client software. Refer to Connect Device to Client Software for details.
- **Image Settings:** It tells you how to set image related parameters of the device via client software. Refer to Image Quality Settings for details.
- **Algorithm Settings:** It tells you how to set the types of barcode to be read, the 1D code algorithm, the 2D code algorithm, etc. Refer to Code Algorithm Settings for details.
- **I/O Control Settings:** It tells you how to set the parameters related to the control of input and output signals of device. Refer to Signal Input Settings and Signal Output Settings for details.
- **Data Processing:** It tells you how to set filter rules for reading barcodes and other data processing related parameters. Refer to Code Reading Result Settings for details.
- **Communication Settings:** It tells you how to select different communication protocols, and set their corresponding parameters. Refer to Communication Settings for details.
- **Configuration Management:** It tells you how to set and manage the user parameters, restart device, etc. Refer to User Set Customization for details.

### Image Quality Settings

This section introduces how to set image related parameters of the device via client software.



For different models of the device, the specific parameters may differ, and the actual device you purchased shall prevail.

#### ■ Set Image

You can set different image parameters like exposure time, gain, Gamma, acquisition frame rate, acquisition burst frame count in image parameters interface.



- Make sure you have select the device to be set in Device Connection before setting image parameters.
- For specific parameter range like exposure time, gain and acquisition frame rate, refer to the device's specification for details.

- **Exposure Time :** You can increase exposure time to improve image brightness. To some extent, increasing exposure time will reduce acquisition frame rate, and impact image quality.
- **Gain :** You can increase gain to improve image brightness. To some extent, increasing gain will create more image noises, and impact image quality.
- **Gamma :** Gamma allows you to adjust the image contrast. It is recommended to reduce Gamma to increase brightness in dark background.
- **Acquisition Frame Rate :** Acquisition frame rate refers to the image number that is acquired by the device per second.
- **Acquisition Burst Frame Count :** Acquisition burst frame count refers to the outputted image number when the device is triggered once.
- **Polling Enable :** It enables the polling function, you can select off, single or multiple mode.



The parameter of polling enable will be displayed only when the trigger mode is on.

## Image Quality Settings

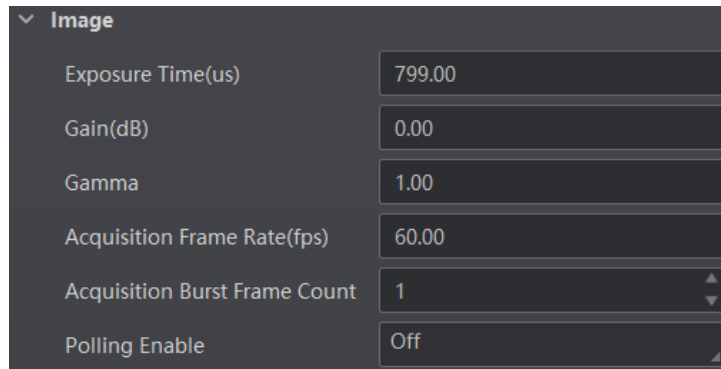

### ■ Set Polling

The polling function allows the device to acquire images based on the parameters you set, including exposure time, gain, Gamma, and light source. Currently, 2 types of polling modes are available, including single mode and multiple mode.

#### Single Mode



- Stopping the real-time acquisition is required before setting the polling function.
- After the polling enabled, the device acquires images with its max. frame rate. Once the polling disabled, the frame rate you set in Acquisition Frame Rate takes effect.
- The polling function, specific parameters as well as parameter values may differ by device models.

#### Steps

1. Go to Image Settings → Image → Polling Enable, and select Single as Polling Enable.
2. Select one parameter (e.g. Param1) from Polling Param.
3. Set Polling Exposure Time, Polling Gain, and Polling Gamma according to actual demands
4. Select Polling Light Selector according to actual demands, and enable Polling Light Enable.

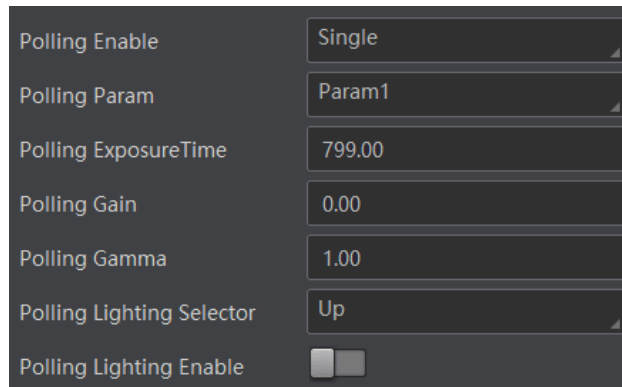

#### Multiple Mode



- The parameter of Best Polling Group Idx is used to display the polling parameter number when the device recognizes codes after enabling polling. If the polling is disabled or polling parameters are edited, it displays 1 by default.
- The rule for multiple-mode polling is that the polling is started from the polling parameter with Best Polling Group Idx, and then execute other polling parameters you selected in turn. For example, if the Param3 is the Best Polling Group Idx and Param1, Param2, Param4 and Param5 are enabled, the polling order is Param3 > Param1 > Param2 > Param4 > Param5.

#### Steps

1. Go to Image Settings → Image → Polling Enable, and select Multiple as Polling Enable.
2. Set Polling Time and Polling Period according to actual demands.
3. Select 2 to 8 sets of parameters (e.g. Param1 and Param2) from Polling Param, and enable Polling Param Enable to let them take effect.
4. Set Polling Exposure Time, Polling Gain, and Polling Gamma for the Polling Param you selected.
5. Select Polling Light Selector according to actual demands, and enable Polling Light Enable.
6. Repeat step 3 to step 5 to set other parameters from Polling Param.

## Image Quality Settings

Polling Enable	Multiple
Polling Status	0
Polling Time	100
Polling Period	1
Best Polling Group Idx	1
Polling Param	Param1
PollingParam Enable	<input type="checkbox"/>
Polling ExposureTime	799.00
Polling Gain	1.00
Polling Gamma	2.00
Polling Lighting Selector	Up
Polling Lighting Enable	<input checked="" type="checkbox"/>

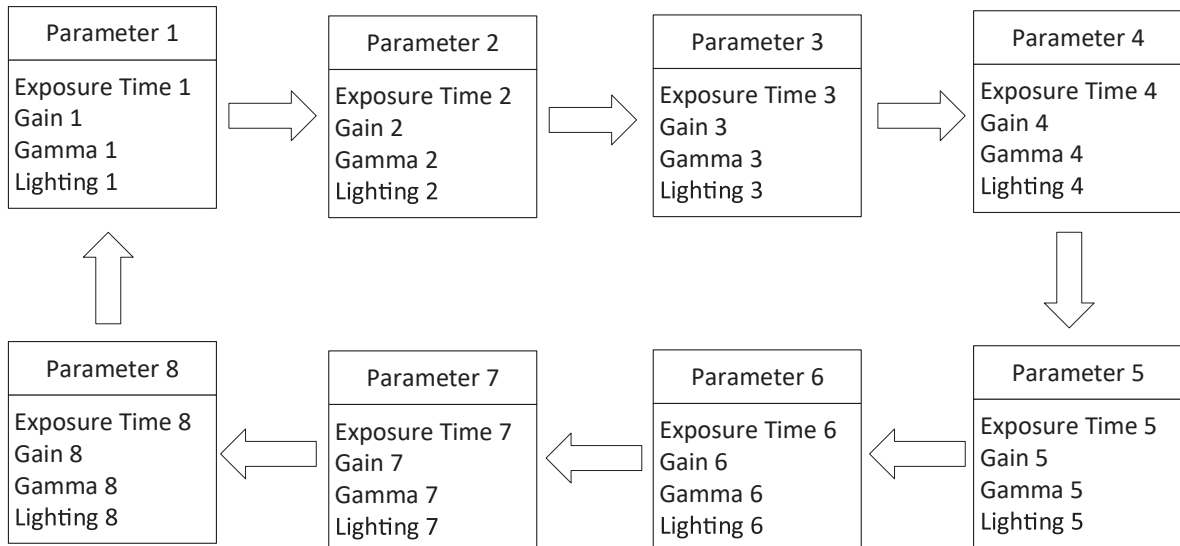

## Image Quality Settings

### ■ Set Light Source

You can select different light types, and set their related parameters in the light interface.



- Light source parameters may differ by device models.
- Make sure you have selected the device to be set in Device Connection before setting light source parameters.

You can select different light sources in Light Type.

#### Own Lighting

It refers to use the device's embedded light source to light during code reading.

#### External Lighting

It refers to the device controls the external light source by triggering output signal during code reading.

#### Non-Lighting

It refers to the device turns off light source during code reading.



If you select Non-Lighting as Light Type, you do not need to set any parameters.

### Set Own Lighting

If you select Own Lighting as Light Type, you can set the following parameters.

#### Aiming Light Enable

You can enable Aiming Light Enable to enable the device's aiming light.



The parameter of aiming light enable may differ by device model.

#### Lighting Selector

You can click lamps on the light source illustration to turn on or turn off lamps on different directions.



The specific lighting selector may differ by device model. For devices with 4 groups of lamps, you can check All to turn on all lamps. For devices with 6 groups of lamps, you can click All On or All Off to turn on or turn off all lamps.

#### Light Mode

It has 2 light modes, including Strobe and Long. Strobe means the light flashes at a specific interval during code reading, and Long means the light is solid during code reading.

#### Lighting Duration

It sets the lighting duration and the unit is  $\mu\text{s}$ .

#### Lighting Delay Time



This parameter is available only when you set Flash Strobe as the Light Mode.

It determines the delay time for lighting after exposure and the unit is  $\mu\text{s}$ .

#### Precharge Time

It determines how earlier the light source starts lighting before exposure and the unit is  $\mu\text{s}$ .



The figure above is only for reference. The specific graphic user interface may differ by device models.

## Image Quality Settings

### Set External Lighting

If you select External Lighting as Light Type, you can set the following parameters.

#### Line Out Duration

The lighting duration of the external light source and the unit is  $\mu\text{s}$ .

#### Line Out Delay Time

It sets the delay time for lighting after device outputs event source, and the unit is  $\mu\text{s}$ .

#### Line Out Ahead Time

It sets how earlier the external light starts lighting before the device outputs event source information, and the unit is  $\mu\text{s}$ .

### Set Lens Focus

The device supports setting lens focus via the client software. 2 ways are available to set lens focus, including auto focus and manual focus.



- The lens focus function may differ by device models.
- Setting the device mode as Test is required before setting lens focus. After completion, you can set the device mode as Normal.
- Setting the trigger mode as off is required before setting lens focus.

### Auto Focus

#### Steps

1. Click in the live view window.
2. Go to Image Settings → Auto Focus, and click Execute in Focus Mode. The device starts to adjust focus automatically.
3. Select the position parameter from Focus Position, and click Execute in Focus Position Save to save the focus position.
4. (Optional) Select the position parameter from Focus Position, and click Execute in Focus Position Load to load saved focus position.

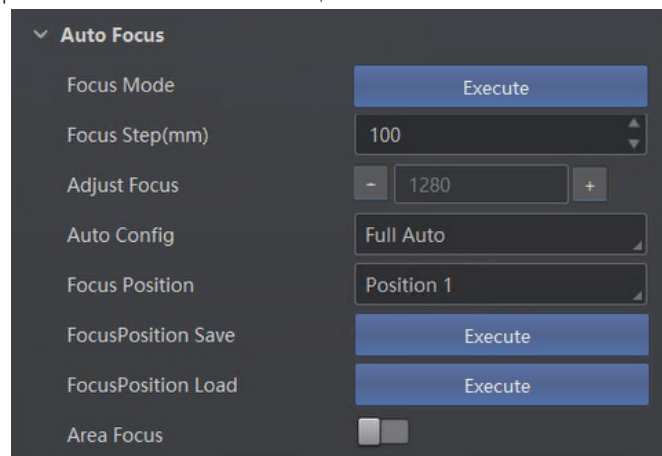

### Manual Focus

1. Go to Image Settings → Auto Focus, and set Focus Step according to actual demands.
2. Click or in Adjust Focus to adjust focus.
3. Select the position parameter from Focus Position, and click Execute in Focus Position Save to save the focus position.
4. (Optional) Select the position parameter from Focus Position, and click Execute in Focus Position Load to load saved focus position.

## Image Quality Settings

### ■ Set Self-Adaptive Adjustment



This function may differ by device models.

The function of self-adaptive adjustment can automatically adjust exposure, gain, Gamma and other parameters to have a better code reading effect.

#### Steps

1.Right click the device in Device Connection, and click Feature Tree.

2.Go to Self Adapt Adjust, and select Adjust Mode.

- High Quality: In this mode, the client software will adjust exposure in priority with small gain and noise. The image quality is high, and this mode is applicable to the scenario for low speed conveyer belt.

- High Speed: In this mode, the client software will adjust gain in priority with small exposure and large gain. The image quality is less high, and this mode is applicable to the scenario for high speed conveyer belt.

3. Select Param Source according to actual demands.

- Default Param: It adjusts the default parameters.

- Polling Param: It adjusts parameters configured in polling.

4.(Optional) Enable or disable Lighting Adapt during self-adaptive adjustment. If it is enabled, the client software will select the best one from all lighting options during the self-adaptive adjustment. If it is disabled, the client software will keep the lighting status before the self-adaptive adjustment.

5.(Optional) Set Gain Max or Exposure Max according to actual demands.

- Gain Max: It is enabled in high quality mode, and it sets the max. gain during the self-adaptive adjustment.

- Exposure Max: It is enabled in high speed mode, and it sets the max. exposure during the self-adaptive adjustment.

6.(Optional) You can set Adjust Timeout to set the duration of the self-adaptive adjustment, and the adjustment will stop if the duration is exceeded. The unit of Adjust Timeout is second.

7.Click Execute in Adjust Start. The device will automatically acquire images and perform self-adaptive adjustment, and stop acquisition after adjustment is completed.



If the adjustment completed, the client software displays the spent time and prompts adjustment succeeded. If the adjustment failed or is timeout, the client software prompts adjustment failure or timeout.

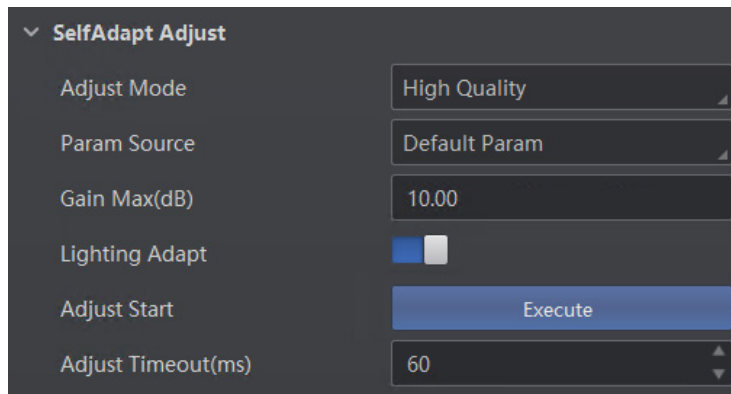

### ■ Set Mirror X

The device supports the mirror X function. If this function is enabled, the image will be reversed in a horizontal way. Go to Image Settings, click All Features, and you can see the Mirror X.



This function is enabled by default, and it may differ by device models.

### ■ Set Test Pattern

Test pattern helps troubleshooting image problems and images in the test pattern are only for test. When exceptions occur in images acquired by the device in real time, you can check if images in the test pattern have similar problems to determine the cause of an exception.



- The test pattern is available in the test or raw device mode.
- Specific parameters of this function may differ by device models.

Go to Image Settings, click All Features, find Test Pattern in Other Features, and set Test Pattern according to actual demands.

## Code Algorithm Settings

The code reader supports reading multiple types of 1D code and 2D code, and you can add and set code parameters via the client software.

### ■ Add Code

Adding code before you set code parameters via the client software. In Algorithm Settings, you can add different types of codes according to actual demands.

In Algorithm Settings, click Add Barcode, select the types of codes to be read, and set the 1D Code Number and 2D Code Number according to actual demands.



- For different models of the device, the specific parameters may differ, and the actual device you purchased shall prevail.
- Selected symbology amount and added code amount may affect the code recognition time. Note that selecting more symbologies or adding more codes may consume more time to recognize codes in the image.
- No matter 1D code or 2D code, up to 20 codes can be added at a time. Note that adding more codes may consume more time to recognize codes in the image. Therefore, the code number is recommended to be set according to the actual demands.
- The code reader may output actual code number when the mismatch between the actual code number and the code number set in the client software occurs.

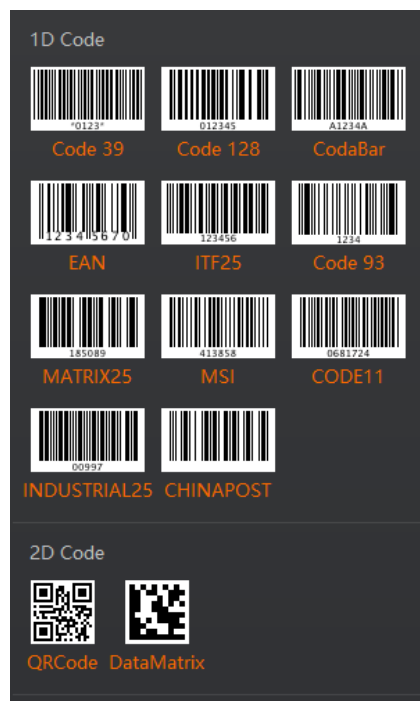

### ■ Set Code Reading ROI

Algorithm ROI (Region of Interest) allows the device to execute algorithms and read codes on the specific area you selected, and thus improving code reading efficiency.

Currently, up to 4 ROIs can be configured, and the device outputs codes according to the number of ROI (e.g. Region 1, Region 2, and Region 3) in turn. The client software supports drawing single group of ROI, drawing ROI in batch, and drawing ROI via chessboard.



- If no code is recognized in the algorithm ROI, and the device will output "noread".
- Before drawing ROIs, make sure that there are images in the live view window after stopping preview.
- If no algorithm ROI is enabled, and the full screen is the algorithm ROI by default.
- This function may differ by device models.

### Draw Single Group of ROI

#### Steps

1. Go to Algorithm Settings, click All Features, and find Algorithm ROI.
2. Click Draw to draw ROI in the live view window.
3. (Optional) Repeat the above step to draw multiple ROIs according to actual demands.



The client software only parse codes in the ROI you drawn.



## Code Algorithm Settings

4. (Optional) Set other ROI parameters according to actual demands.

- ROI Index: It indicates different ROIs and ranges from 0 to 149 which corresponds 1 to 150 ROIs.
- Draw ROI Width: It refers to the width in algorithm ROI.
- Draw ROI Height: It refers to the height in algorithm ROI.
- Draw ROI Offset X: It refers to the X coordinate of the upper left corner in algorithm ROI.
- Draw ROI Offset Y: It refers to the Y coordinate of the upper left corner in algorithm ROI.



The result of Draw ROI Width plus Draw ROI Offset X cannot be larger than the overall horizontal resolution, and the result of Draw ROI Height plus Draw ROI Offset Y cannot be larger than the overall vertical resolution.

5.(Optional) Click Execute in Restore Max. Algorithm ROI to restore the ROI to the full screen.

6.(Optional) Click Execute in Clear All ROI to delete all ROIs.

7.(Optional) Enable ROI Link IO Enable in Algorithm Control, and there will be prompts by the output device when codes are not read in any ROI.



Make sure that the output device is connected when using this function.

### Draw ROI in Batch

#### Steps

1.Go to Algorithm Settings, click All Features, and find Algorithm ROI.

2.Click Batch to set parameters according to actual demands.

- Area Offset: It sets the pixel quantity from the starting point when the ROI is in horizontal and vertical direction from the full resolution.
- Area Size: It sets the pixel quantity in the horizontal and vertical direction of the ROI.
- ROI Number: It sets the row and column quantity.
- Row Spacing: It sets the interval between rows.
- Column Spacing: It sets the interval between columns.

3.Click OK after settings.

4.Repeat other optional steps mentioned in drawing single group of ROI according to actual demands.

5. (Optional) Enable ROI Link IO Enable in Algorithm Control, and there will be prompts by the output device when codes are not read in any ROI.



Make sure that the output device is connected when using this function.

## Code Algorithm Settings

### Draw ROI via Chessboard

#### Steps

1. Go to Algorithm Settings, click All Features, and find Algorithm ROI.
2. Click Execute in Chessboard ROI, set parameters according to actual demands, and click OK after setting.

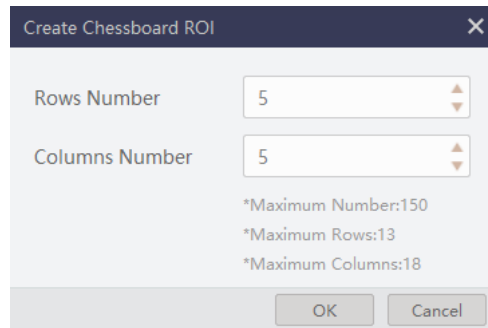

3. Click ✓ after creating ROI, and the red frame becomes green as shown below.

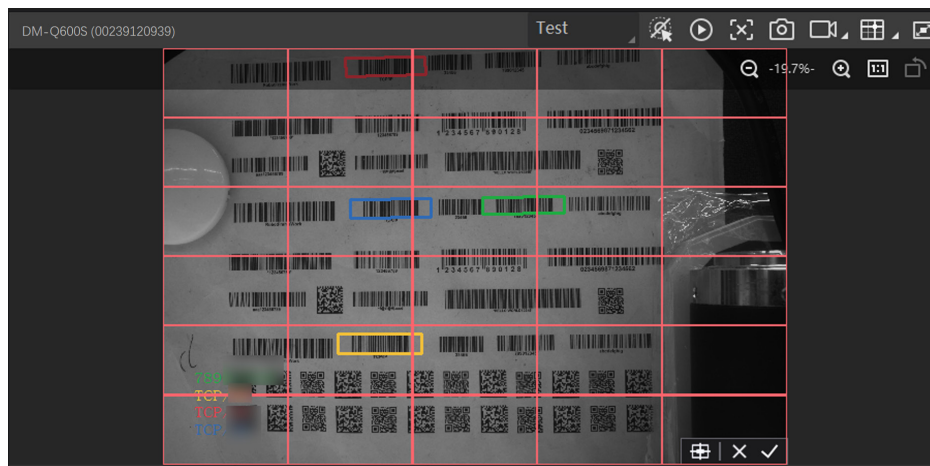

4. (Optional) Click + to restore the ROI to the full screen, and click × to clean all configured ROIs.
5. Repeat other optional steps mentioned in drawing single group of ROI according to actual demands.
6. (Optional) Enable ROI Link IO Enable in Algorithm Control, and there will be prompts by the output device when codes are not read in any ROI.



- Make sure that the output device is connected when using this function.
- The figures above are for reference only, and refer to the actual conditions.

## Code Algorithm Settings

### ■ Set 1D Algorithm Parameter

Click All Features on the upper-right to display all algorithm parameters. In the Algorithm Parameter page, select 1D Code as Arithmetic Type, and then you can set its corresponding parameters.



- You should have selected at least one type of 1D code.
- For different models of the device, the specific parameters may differ, and the actual device you purchased shall prevail.

#### Timeout Value

Timeout value refers to the maximum running time of algorithm, and its unit is ms. The code reader will stop parsing the images and return results if the time is exceeded the waiting time configured.

#### Code Color

It defines the readable code color. White Code On Black Wall means that the client software can recognize the white code with black background. Black Code On White Wall means that the client software can recognize the black code with white background.

#### Code 39 Check

Enable this parameter if Code 39 uses the parity bit.



You need to select Code 39 in Add Barcode.

#### ITF 25 Check

Enable this parameter if ITF 25 uses the parity bit.



You need to select Code 39 in Add Barcode.

#### Code Score Enable

If it is enabled, the device will evaluate code quality and display overall grade and code score in history record area of the client software. The higher the score, and the better the code quality.

#### Accurate Timeout Enable

If it is enabled, the accuracy of algorithm timeout will improve.

### ■ Set 2D Algorithm Parameter

Click All Features on the upper-right to display all algorithm parameters. In the Algorithm Parameter page, select 2D Code as Arithmetic Type, and then you can set its corresponding parameters.



- You should have selected at least one type of 2D code.
- For different models of the device, the specific parameters may differ, and the actual device you purchased shall prevail.

#### Timeout Value

Timeout value refers to the maximum running time of algorithm, and its unit is ms. The code reader will stop parsing the images and return results if the time is exceeded the waiting time configured.

#### Algorithm Running Mode

It is used to be set the algorithm operating mode. It includes High Speed, High Performance, and Balance. High Speed focuses on recognition speed, and the algorithm can recognize the code rapidly, while High Performance refers to the algorithm can recognize the code that has distortion, spot or white gap, but its recognition speed is slow. Balance refers to the algorithm makes a balance between speed and performance.

#### 2D Code Max. Size

It refers to the max. recognizable code width. The 2D code will not be recognized if its width exceeds the configured value.

#### Mirror Mode

It is useful when the recognized image is a mirror one, mirroring in X coordinate. 3 modes are available: Adaptive, Mirror, and Non Mirror.

#### Downsampling Level

It refers to the pixel sample size that the code reader takes. Increasing this parameter will improve the code reading efficiency at the expense of code recognition rate.





Increasing this parameter value will improve the code reading efficiency at the cost of code recognition rate.

## Code Algorithm Settings

### Code Color

It defines the readable code color. Adaptive means that the client software can recognize both the black code with white background, and the white code with black background. White Code On Black Wall means that the client software can recognize the white code with black background. Black Code On White Wall means that the client software can recognize the black code with white background.







For QR code, the code color is determined by the color of the concentric square on it.  indicates that the code color is white, and  indicates that the code color is black.



For DM code, the code color is determined by the color of its "L" shaped sides. White "L" shaped sides indicate that the code color is white, and black "L" shaped sides indicate that the code color is black.



### Discrete Flag

Continuous stands for the minimum units in the "L" shaped sides of the DM code are continuous, or the minimum units in the concentric square like  or  in the QR code are continuous. Usually the continuous code uses squares as the minimum units. Discrete stands for the minimum units in the "L" shaped sides of the DM code are discrete, or the minimum units in the concentric square like  or  in the QR code are discrete. Usually the discrete code uses dots as the minimum units. Adaptive stands for the device can recognize both continuous code and the discrete code.

### QR Distortion Correction

If the QR code or DM code is distorted, you can enable this parameter to improve code recognition rate.



If you enable this parameter, the more time will be consumed to recognize the codes in the image.

### Advance Param

This parameter is applicable to some special codes, and it is recommended to use the default value.

### DM Code Shape

It defines the recognizable code shape. Square stands for square mode: If the 2D code is square shaped, it can be recognized by the device. Rectangle stands for rectangle mode: If the 2D code is rectangle shaped, it can be recognized by the device. Adaptive stands for compatible mode: The device can recognize 2D codes of both the above-mentioned two shapes.

### DM Code Type

It includes All, ECC140, and ECC200.

### 2D Code Quality Enable

Refer to section Set 2D Code Quality Evaluation for details.

### Code Score Enable

If it is enabled, the device will evaluate code quality and display overall grade and code score in history record area of the client software. The higher the score, and the better the code quality.

### Accurate Timeout Enable

If it is enabled, the accuracy of algorithm timeout will improve.

## Code Algorithm Settings

### ■ Set 2D Code Quality Evaluation

After 2D Code Quality Enable, you can set specific parameters according to actual demands.



- The function of code quality evaluation may differ by device models.
- In test mode, this function is enabled by default. In normal mode, you need to enable it manually.

#### Steps

1. Set Sym Proc Type according to actual demands, and the default type is Type 1. Type 1 has a strong capacity to locate codes.

2. Set Iso Edition, including Iso15415 and Iso29158

- Iso15415 is applicable to the quality evaluation for label 2-dimensional codes.
  - Iso29158 is applicable to the quality evaluation for DPM format 2-dimensional codes.
3. Set Verify Edition<Standard mode>. Standard mode is a standard quality evaluation mode.
4. Set Standard Aperture and Magnification.
- Standard aperture refers to a standard aperture, and its default value is 400.
  - Magnification is 150 by default.



Standard Aperture and Magnification should be configured only when Type 2 is selected as Sym Proc Type.

5. Click to start acquisition, and the client software will display the overall code quality in the history area.

No.	Read Time	Cost Time(ms)	PPM	Barcode Type	Waybil	Barcode Content	Overall Grac	Code Score
5	2021/1/25 15:02:31:274	301	7.4	DataMatrix		D78005765	F	26
4	2021/1/25 15:02:31:274	301	6	DataMatrix		number: 1,datamatrix	F	21
3	2021/1/25 15:02:29:191	170	7.5	DataMatrix		D78005765	F	25



The overall grade includes A, B, C, D and F. A means that the code quality is the best while F means that the code quality is the worst.

6. (Optional) Click specific grade in the overall grade list to view different quantity evaluation items.

## Code Algorithm Settings

### ■ Set Code Score

After enabling code score function, the client software can output specific score for codes it has read.



- The function of code score may differ by device models.
- In test mode, this function is enabled by default. In normal mode, you need to enable it manually.
- The code score is determined by two factors including image quality and print quality of codes. The range of code score is between 0 and 100, and the higher the score, and easier the code can be read.

#### Steps

1. Right click the device in Device Connection, and click Feature Tree.
2. Go to Algorithm Control, and enable Code Score Enable.

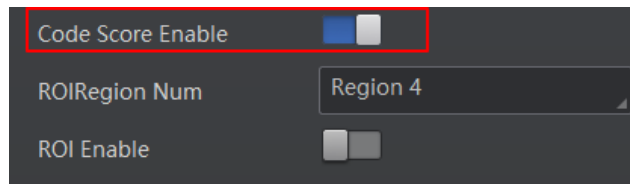

3. Click to start acquisition, and the client software will display specific code score in the history area.

No.	Read Time	Cost Time(ms)	PPM	Barcode Type	Waybil	Barcode Content	Overall Grac	Code Score
5	2021/1/25 15:02:31:274	301	7.4	DataMatrix		D78005765	E	26
4	2021/1/25 15:02:31:274	301	6	DataMatrix		number: 1_datamatrix	E	21
3	2021/1/25 15:02:29:191	170	7.5	DataMatrix		D78005765	E	25

4. (Optional) Go to Image Settings, and adjust parameters like exposure time, gain, Gamma, light source, etc. if the code score is low.



If the code score is still low after adjusting, and the code may have poor printing quality.

## Signal Input Settings

In the signal input module, you can set the trigger related parameters. You can enable trigger mode to let the acquisition of image data occur only when the trigger source is generated.

### ■ Set Trigger Mode

The device has 2 types of trigger mode: Internal trigger mode and external trigger mode.

#### Internal Trigger Mode

In this mode, the device acquires images via its internal signals.

#### External Trigger Mode

In this mode, the device acquires images via external signals like software signal and hardware signal. The trigger source of external trigger mode includes software, physical lines, counter, TCP, UDP, and serial.

### ■ Enable Internal Trigger Mode

In the internal trigger mode, the device acquires images via its internal signals. You have 2 methods to enable the internal trigger mode:

- Click I/O Control Settings → Input → Trigger Mode, and select Off as Trigger Mode.
- In the live view page, click  to enable the internal trigger mode.

### ■ Enable External Trigger Mode

In the external trigger mode, the device acquires images via external signals like software signal and hardware signal. You have 2 methods to enable the external trigger mode:

- Click I/O Control Settings → Input → Trigger Mode, and select On as Trigger Mode.
- In the live view page, click  to enable the external trigger mode.

### Set and Execute Software Trigger Mode

In software trigger, the software sends trigger signal to the device via I/O interface to acquire images.

#### Steps

1. Click I/O Control Settings → Input → Trigger Mode.
2. Select On as Trigger Mode.
3. Select Software as Trigger Source.
4. Click Execute in Trigger Source to send trigger commands.

You can also enter Auto Trigger Time, and then enable Enable Auto Trigger to let the client software automatically send trigger signal to device according to the interval you set.

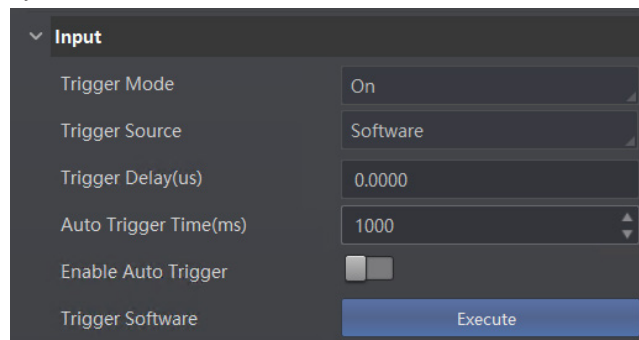

### Set and Execute Hardware Trigger Mode

#### Steps

1. Click I/O Control Settings → Input → Trigger Mode.
2. Select On as Trigger Mode.
3. Select the specific line as Trigger Source according to actual demands.
4. Set Debounce Time and Line Out Trigger In Polarity according to actual demands.



- When selecting Rising Edge or Falling Edge as Line Out Trigger In Polarity, you can set Trigger Delay.
- When selecting Level High or Level Low as Line Out Trigger In Polarity, you can set Start Delay Time and End Delay Time according to actual demands.

## Signal Input Settings

The screenshot shows the 'Input' settings panel with the following configurations:

Setting	Value
Trigger Mode	On
Trigger Source	LineIn 0
Trigger Delay(us)	0.00
Debounce Time(us)	1000
Line Out Trigger In Polarity	Rising Edge

### Set and Execute Counter Trigger Mode

Counter specifies that the trigger source will be generated after the set number of valid signals appears. For example, if you set the Count Number to 3, the trigger source will be generated after 3 signals appear.

#### Steps

1. Click I/O Control Settings → Input → Trigger Mode.
2. Select On as Trigger Mode.
3. Select Counter 0 as Trigger Source.
4. Set Trigger Delay, Count Number, Count Source and Line Out Trigger In Polarity according to actual demands.

The screenshot shows the 'Input' settings panel with the following configurations:

Setting	Value
Trigger Mode	On
Trigger Source	Counter 0
Trigger Delay(us)	0.00
Count Number	1
Count Source	Off
Line Out Trigger In Polarity	Falling Edge

### Set and Execute TCP Trigger Mode

TCP start specifies the TCP server as the source for the trigger signal. When the server receives the specified string text, the trigger signal will be outputted.

Click I/O Control Settings → Input → Trigger Mode, select On as Trigger Mode and select TCP Start as Trigger Source. Set Trigger Delay, Tcp Trigger Port, and Tcp Start Trigger Text according to actual demands.

The screenshot shows the 'Input' settings panel with the following configurations:

Setting	Value
Trigger Mode	On
Trigger Source	TCP Start
Trigger Delay(us)	0.00
TCP Trigger Port	2001
TCP Start Trigger Text	start

### Set and Execute UDP Trigger Mode

UDP start specifies the UDP server as the source for the trigger signal. When the server receives the specified string text, the trigger signal will be outputted.

Click I/O Control Settings → Input → Trigger Mode, select On as Trigger Mode and select UDP Start as Trigger Source. Set Trigger Delay, Udp Trigger Port, and Udp Start Trigger Text according to actual demands.

The screenshot shows the 'Input' settings panel with the following configurations:

Setting	Value
Trigger Mode	On
Trigger Source	UDP Start
Trigger Delay(us)	0.00
UDP Trigger Port	2002
UDP Start Trigger Text	start



## Signal Input Settings

### Set and Execute Serial Port Trigger Mode

Serial start specifies the serial port as the source for the trigger signal. When the serial port receives the specified string text, the trigger signal will be outputted.

Click I/O Control Settings → Input → Trigger Mode, select On as Trigger Mode and select Serial Start as Trigger Source.

Set Trigger Delay, Serial Baudrate, Serial Data Bits, Serial Parity, Serial Stop Bits, and Serial Start Trigger Text according to actual demands.

The screenshot shows the 'Input' settings menu with the following configurations:

Setting	Value
Trigger Mode	On
Trigger Source	Serial Start
Trigger Delay(us)	0.00
Serial Baudrate	9600
Serial Data Bits	8
Serial Parity	No Parity
Serial Stop Bits	1
Serial Start Trigger Text	start

### Set and Execute Self Trigger Mode

Self trigger mode allows you to trigger the device according to the trigger period you configured.

#### Steps

1. Click I/O Control Settings → Input → Trigger Mode.
2. Select On as Trigger Mode.
3. Select Self Trigger as Trigger Source, and set Self Trigger Period and Self Trigger Count.
4. Click Execute in Self Trigger Start to start, and click Execute in Self Trigger Stop to stop.

The screenshot shows the 'Input' settings menu with the following configurations:

Setting	Value
Trigger Mode	On
Trigger Source	Self Trigger
Self Trigger Period(ms)	300
Self Trigger Count	0
Self Trigger Start	Execute
Self Trigger Stop	Execute
Trigger Cache	<input type="checkbox"/>

## Signal Input Settings

### ■ Stop Trigger

The device supports stopping trigger via TCP, UDP, I/O, and serial port. You can also set code reading timeout duration or max. barcode amount to be read to stop trigger. After stopping trigger is completed, the device cannot make response to trigger again.

#### Stop Trigger via IO

You can stop a trigger via IO: Enabling IO Stop Trigger Enable first, select specific sources from IO Stop Trigger Selector, and then select the trigger polarity as the condition to stop trigger.

Stop Trigger settings for IO:

- TCP Stop Trigger Enable:
- UDP Stop Trigger Enable:
- IO Stop Trigger Enable:
- IO Stop Trigger Selector: LineIn0

When selecting SoftwareTriggerEnd as IO Stop Trigger Selector, you can click Execute in Software Stop Trigger to stop current trigger.

Stop Trigger settings for IO (SoftwareTriggerEnd selected):

- TCP Stop Trigger Enable:
- UDP Stop Trigger Enable:
- IO Stop Trigger Enable:
- IO Stop Trigger Selector: SoftwareTriggerEnd
- Software Stop Trigger: Execute

#### Stop Trigger via Serial

When the specified serial port receives the specified string text, the trigger will be stopped. The client software sends stop trigger command to the device after Serial Stop Trigger Enable is enabled.

You should enter Serial Stop Trigger Text, Serial Baudrate, Serial Data Bits, Serial parity, and Serial Stop Bits according to actual demands. The Serial Baudrate includes 4800, 9600, 19200, 38400, 57600 and 115200, and Serial Data Bits is 8.

Stop Trigger settings for Serial:

- TCP Stop Trigger Enable:
- UDP Stop Trigger Enable:
- IO Stop Trigger Enable:
- Serial Stop Trigger Enable:
- Serial Stop Trigger Text: stop
- Serial Baudrate: 9600
- Serial Data Bits: 8
- Serial Parity: No Parity
- Serial Stop Bits: 1

#### Stop Trigger via UDP

When the UDP server receives the specified string text, the trigger will be stopped. The client software sends stop trigger command to the device after Udp Stop Trigger Enable is enabled. You should enter Udp Trigger Port and Udp Stop Trigger Text according to actual demands. The range of Udp Trigger Port is from 1025 to 65535, and the default port is 2002.

Stop Trigger settings for UDP:

- TCP Stop Trigger Enable:
- UDP Stop Trigger Enable:
- UDP Trigger Port: 2002
- UDP Stop Trigger Text: stop

## Signal Input Settings

### Stop Trigger via TCP

When the TCP server receives the specified string text, the trigger will be stopped. The client software sends stop trigger command to the device after Tcp Stop Trigger Enable is enabled. You should enter Tcp Trigger Port and Tcp Stop Trigger Text according to actual demands. The range of Tcp Trigger Port is from 1025 to 65535, and the default port is 2001.

Stop Trigger

TCP Stop Trigger Enable

TCP Trigger Port 2001

TCP Stop Trigger Text stop

### Stop Trigger via Timeout Duration



TimeOut Stop Trigger Enable is only available when the device mode is set to Normal and the Trigger Mode is On.

When the trigger time reaches the specified maximum value (in ms), the trigger will be stopped. You can enable TimeOut Stop Trigger Enable, and set Maximum Output Limited Time according to actual demands. The range of Maximum Output Limited Time is 0 to 10000 ms.

TimeOut Stop Trigger Enable

Maximum Output Limited Time(ms) 10000

### Stop Trigger via Code Number



CodeNum Stop Trigger Enable is only available when the device mode is set to Normal and the Trigger Mode is On.

This function means that the code quantity outputted by the device is restricted to the settings you configured here. You can enable CodeNum Stop Trigger Enable, and set CodeNum Stop Trigger Min and CodeNum Stop Trigger Max according to actual demands.

- If the outputted code quantity is smaller than configured CodeNum Stop Trigger Min, and the device will output codes continuously.
- If the outputted code quantity is smaller than configured CodeNum Stop Trigger Max, and the device will stop outputting codes.
- If the outputted code quantity is between configured CodeNum Stop Trigger Min and CodeNum Stop Trigger Max, and the device will read and output codes according to trigger signals.
- If CodeNum Stop Trigger Min is same with CodeNum Stop Trigger Max, and the device will stop outputting codes when the number of outputted codes reaches the configured number.

CodeNum Stop Trigger Enable

CodeNum Stop Trigger Min 1

CodeNum Stop Trigger Max 3

## Signal Output Settings

### ■ Select Output Signal

The device's output signal can control external devices like PLC, flashing light, etc. Click I/O Control Settings → Output → Line Out Selector to select output signal.

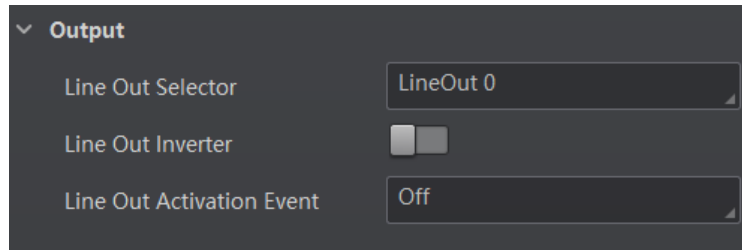

### ■ Enable Line Inverter

The level inverter function allows the device to invert the electrical signal level of an I/O line, and meets requirements of different devices for high or low electrical signal level. You can go to I/O Control Settings → Output → Line Out Inverter to enable it.



The Line Out Inverter function is disabled by default.

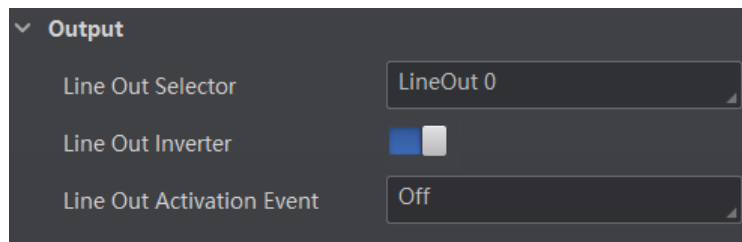

### ■ Set Event Source

The device supports outputting different trigger signals according to the event source you select. Click I/O Control Settings → Output → Line Out Activation Event to select event source. The device supports following event sources, including Off, Acquisition Start Active, Acquisition Stop Active, Frame Burst Start Active, Frame Burst Stop Active, Exposure Start Active, Soft Trigger Active, Hard Trigger Active, Counter Active, Timer Active, No Code Read, Read Success, and Light Strobe Long.



You need to set different parameters when selecting these event sources.

### Select Acquisition Start Active

If acquisition starts, the output signal will be triggered. When you select Acquisition Start Active as Line Out Activation Event, you can set its output delay time and duration.

#### Line Out Delay Time

It sets the delay time for outputting the output signal.

#### Line Out Duration

It sets the time duration of the output signal.

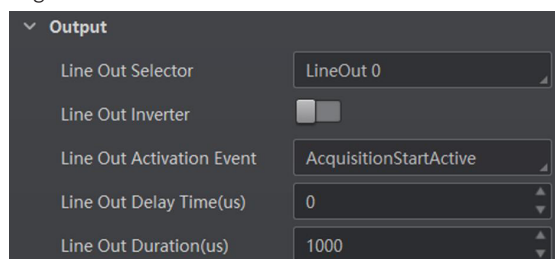

## Signal Output Settings

### Select Acquisition Stop Active

If acquisition stops, the output signal will be triggered. When you select Acquisition Stop Active as Line Out Activation Event, you can set its output delay time and duration.

#### Line Out Delay Time

It sets the delay time for outputting the output signal.

#### Line Out Duration

It sets the time duration of the output signal.

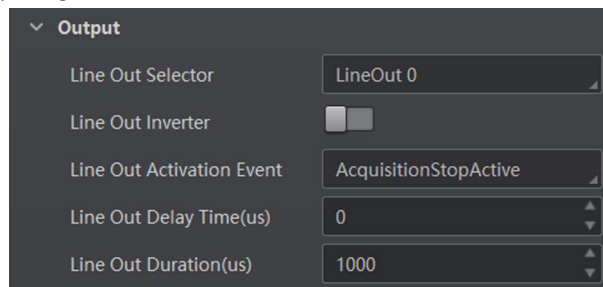

### Select Frame Burst Start Active



The Frame Burst Start Active is not supported when the trigger polarity is level high or level low.

If the burst of a frame starts, the output signal will be triggered. When you select Frame Burst Start Active as Line Out Activation Event, you can set its output delay time and duration.

#### Line Out Delay Time

It sets the delay time for outputting the output signal.

#### Line Out Duration

It sets the time duration of the output signal.

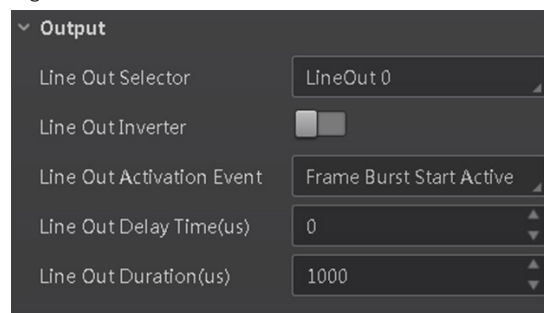

### Select Frame Burst Stop Active



The Frame Burst Stop Active is not supported when the trigger polarity is level high or level low.

If the burst of a frame stops, the output signal will be triggered. When you select Frame Burst Stop Active as Line Out Activation Event, you can set its output delay time and duration.

#### Line Out Delay Time

It sets the delay time for outputting the output signal.

#### Line Out Duration

It sets the time duration of the output signal.

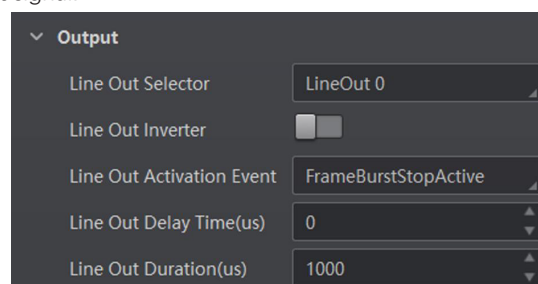

## Signal Output Settings

### Select Exposure Start Active



For different models of device, when selecting Exposure Start Active as Line Out Activation Event, the specific parameters may be different. The actual product you purchased shall prevail.

If you select Exposure Start Active as Line Out Activation Event, you can set its output delay time, duration, and ahead time.

#### Line Out Delay Time

It sets the delay time for outputting the signal.

#### Line Out Duration

It sets the duration for outputting the signal.

#### Line Out Ahead Time

It sets the ahead time for outputting the signal.

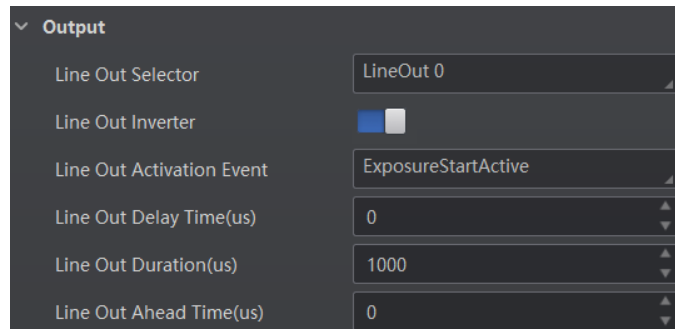

### Select Soft Trigger Active

If you select Soft Trigger Active as Line Out Activation Event, you can set its output delay time, duration, and execute outputting signal manually.

#### Line Out Delay Time

It sets the delay time for outputting the signal.

#### Line Out Duration

It sets the duration for outputting the signal.

#### Line Trigger Software

Click Execute for manually outputting the output signal.

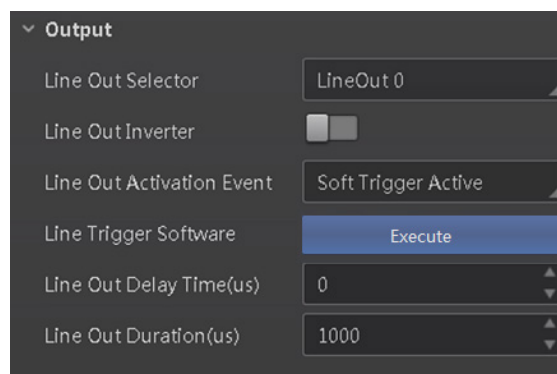

## Signal Output Settings

### Select Hard Trigger Active

If you select Hard Trigger Active as Line Out Activation Event, you can set its output delay time, duration, trigger source, and trigger activation.

#### Line Out Delay Time

It sets the delay time for outputting the output signal.

#### Line Out Duration

It sets the time duration of the output signal.

#### Hardware Trigger Source

It sets the hardware trigger source, including LineIn 0, LineIn 1, and LineIn 2.

#### Hardware Trigger Activation

It sets the trigger activation of input signal, including Rising Edge and Falling Edge.

The screenshot shows the 'Output' settings panel with the following configurations:

- Line Out Selector: LineOut 0
- Line Out Inverter:
- Line Out Activation Event: Hard Trigger Active
- Hardware Trigger Source: LineIn 0
- Hardware Trigger Activati...: Rising Edge
- Line Out Delay Time(us): 0
- Line Out Duration(us): 1000

### Select Counter Active

Counter active means that the counter triggers the output signal. When you select Counter Active as Line Out Activation Event, you can set its output delay time and duration.

#### Line Out Delay Time

It sets the delay time for outputting the output signal.

#### Line Out Duration

It sets the time duration of the output signal.

The screenshot shows the 'Output' settings panel with the following configurations:

- Line Out Selector: LineOut 0
- Line Out Inverter:
- Line Out Activation Event: CounterActive
- Line Out Delay Time(us): 0
- Line Out Duration(us): 1000

### Select Timer Active

If you select Timer Active as Line Out Activation Event, you can set its output duration and period.

#### Line Out Duration

It sets the time duration of the output signal.

#### Line Out Period

It sets the time period of the output signal.

The screenshot shows the 'Output' settings panel with the following configurations:

- Line Out Selector: LineOut 0
- Line Out Inverter:
- Line Out Activation Event: TimerActive
- Line Out Duration(us): 1000
- Line Out Period(us): 1000

## Signal Output Settings

### Select No Code Read

If you select No Code Read as Line Out Activation Event, you can set its output delay time and duration.

#### Line Out Delay Time

It sets the delay time for outputting the output signal.

#### Line Out Duration

It sets the time duration of the output signal.

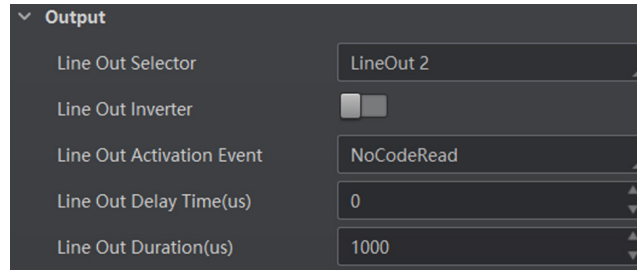

The screenshot shows a dark-themed settings panel titled "Output". It contains five rows of controls:

- Line Out Selector:** A dropdown menu with "LineOut 2" selected.
- Line Out Inverter:** A toggle switch that is currently turned off.
- Line Out Activation Event:** A dropdown menu with "NoCodeRead" selected.
- Line Out Delay Time(us):** A numeric input field with the value "0".
- Line Out Duration(us):** A numeric input field with the value "1000".

### Select Read Success

If you select Read Success as Line Out Activation Event, you can set its output delay time and duration.

#### Line Out Delay Time

It sets the delay time for outputting the output signal.

#### Line Out Duration

It sets the duration for outputting the signal.

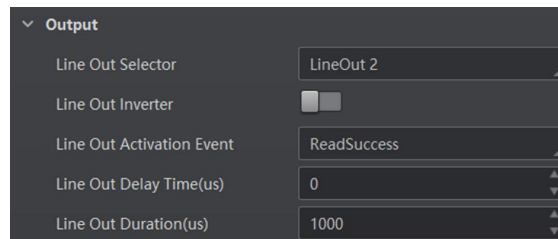

The screenshot shows a dark-themed settings panel titled "Output". It contains five rows of controls:

- Line Out Selector:** A dropdown menu with "LineOut 2" selected.
- Line Out Inverter:** A toggle switch that is currently turned off.
- Line Out Activation Event:** A dropdown menu with "ReadSuccess" selected.
- Line Out Delay Time(us):** A numeric input field with the value "0".
- Line Out Duration(us):** A numeric input field with the value "1000".

### Select Light Strobe Long

If you select Light Strobe Long as Line Out Activation Event, you do not need to set any parameters.



## Code Reading Result Settings

In Data Processing module, you can set filter rules for reading barcodes and other data processing related parameters.

### ■ Set Code Reading Result Output Mode

There are 2 types of output modes when the device mode is Normal and trigger mode is On: Instant output mode and non-instant output mode.

- Instant output mode means that the device can instantly output code reading results when recognizing codes if you enable Instant Output Mode Enable in Filter Rule.
- Non-instant output mode means that the device does not output code reading results it recognized until the trigger stops if Instant Output Mode Enable is not enabled. If the device does not recognize any codes during the whole process, images it captured will be output, and you can set which images to be outputted in NoRead Image Index.

When the device mode is Normal and trigger mode is Off, you can set Filter Time in Filter Rule. Within the configured Filter Time, the device will not output any code information.



The filter rule and data processing parameters may differ with different device modes and trigger modes.

### ■ Set Filter Rule

You can set rules to filter unwanted barcodes to improve the reading efficiency in Filter Rule. Two filter modes are available, including normal mode and regular expression mode. You can set it in Filter Mode.



The filter rule parameters may differ with different device modes and trigger modes.

#### Normal Filter Mode

When the device mode is Normal, Trigger Mode is On, and Filter Mode is Normal, you can set the following parameters according to actual demands.

##### Instant Output Mode Enable

If this parameter is enabled, the device can instantly output code reading result when recognizing codes. If it is not enabled, the device will not output code reading result until the trigger stops.

##### Min. Output Time

It sets the min. waiting time before data output. For example, if you set 500 ms as Minimum Output Time, the barcode would not be outputted until 500 ms is passed.

##### Numeral Filter

If this parameter is enabled, the device will only parse and read the numeral contents of the barcodes, and the non-numeral contents will be filtered out.

##### Max Output Length

It sets the max. code length that can be outputted.

##### Code Offset Num

It sets the range of barcode to be filtered. For example, the barcode is ABCDEFG, if you set this parameter as 2, the device will output CDEFG at last and filter AB.

##### Begin with Specific Character for Result

If this parameter is enabled, the device will only read the barcodes which begin with a specific character. Otherwise, the barcodes will be filtered out. You can enter the specific character in Begin with.

##### Include Specific Character in Barcode

If this parameter is enabled, the device will only read the barcodes which include a specific character. Otherwise, the barcodes will be filtered out. You can enter the specific character in Character.

##### Exclude Specific Character in Barcode

If this parameter is enabled, the device will only read the barcodes which exclude a specific character. Otherwise, the barcodes will be filtered out. You can enter the specific character in Character.

##### Min. Code Length

If the length of a barcode is shorter (in terms of the number of characters contained in the barcode) than the configured value, the device will not parse the contents of the barcode. The valid value is from 1 to 256. For example, if you set the value as 6, the device will not parse the contents of the barcodes which contain less than 6 characters.

##### Max. Code Length

If the length of a barcode is longer ((in terms of the number of characters contained in the barcode) than the configured value, the device will not parse the contents of the barcode. The valid value is from 1 to 256. For example, if you set the value as 9, the device will not parse the contents of the barcodes which contain more than 9 characters.

## Code Reading Result Settings

### Read Times Threshold

If the reading results of a barcode is same for the configured times, the barcode will be regarded as valid and its reading result will be outputted. Or the barcode will be regarded as invalid and its reading result will not be outputted.

### De-duplication Enable

If it is enabled, the repeated code information will be filtered within specific trigger times. You can set trigger times in De-duplication Windows Size, and its default value is 1.

### De-duplication By ROI

If it is enabled, the device will filter information based on drawn ROIs.

## Regular Expression Filter Mode

### Instant Output Mode Enable

If this parameter is enabled, the device can instantly output code reading result when recognizing codes. If it is not enabled, the device will not output code reading result until the trigger stops.

### Min. Output Time

It sets the min. waiting time before data output. For example, if you set 500 ms as Minimum Output Time, the barcode would not be outputted until 500 ms is passed.

### Max Output Length

It sets the max. code length that can be outputted.

### Code Offset Num

It sets the range of barcode to be filtered. For example, the barcode is ABCDEFG, if you set this parameter as 2, the device will output CDEFG at last and filter AB.

### Regular Expression

It selects the regular expression from order 1 to order 10. You can enter specific regular expression contents in Regular Expression Filter. Up to ten regular expression rules can be set at the same time. Once one regular expression is met, code can be outputted.

### Regular Expression Filter

It sets the specific regular expression contents.

### Min. Code Length

If the length of a barcode is shorter (in terms of the number of characters contained in the barcode) than the configured value, the device will not parse the contents of the barcode. The valid value is from 1 to 256. For example, if you set the value as 6, the device will not parse the contents of the barcodes which contain less than 6 characters.

### Max. Code Length

If the length of a barcode is longer (in terms of the number of characters contained in the barcode) than the configured value, the device will not parse the contents of the barcode. The valid value is from 1 to 256. For example, if you set the value as 9, the device will not parse the contents of the barcodes which contain more than 9 characters.

### Read Times Threshold

If the reading results of a barcode is same for the configured times, the barcode will be regarded as valid and its reading result will be outputted. Or the barcode will be regarded as invalid and its reading result will not be outputted.

Filter Rule	
Instant Output Mode Enable	<input type="checkbox"/>
Min Output Time(ms)	0
Filter Mode	Regular Expression
Max Output Length	256
Code Offset Num	0
SortOnExpressSortSet	order1
Regular Expression Filter	
Min Code Length	1
Max Code Length	256
Read Times Threshold	1

## Code Reading Result Settings

### ■ Set Result Format

Result format settings allow you to set the format and contents contained in the outputted barcode information. Result format is related to communication protocol and trigger mode. With different selected communication protocol and trigger mode, you need to set corresponding parameters.



- Result format settings are only available if you select Smart SDK, TCP Client, TCP Server, Serial, FTP, Profinet, Melsec, Ethernet/IP, ModBus, Fins, and SLMP as the communication protocol when the device mode is Normal.
- For details about communication protocol, see section Communication Settings for details.
- The specific parameter names and values may differ by device firmware versions.

### Result Output via Smart SDK

When the communication protocol is Smart SDK, device mode is Normal and trigger mode is On, you can set following parameters.

#### Sorting Rules

It decides the output order of codes, and you can select it according to actual demands.

#### One By One Enable

If it is enabled, the device will send one piece of code information each time in accordance with the specified interval. You can set the interval via One By One Interval and the default value 100 ms.

#### Local Save Picture Mode

It includes Off and NoRead. You can select NoRead to let the device save images when no code is read.

#### Local Picture Type

It sets the image saving type, including JPEG and BMP.

#### Local Override Strategy

It includes Off, Max Count, Loop Max Count, and Reserve Space. Off means that disk will not be overridden. Max Count means that the device will save image quantity configured in Local Override Max. Count, and no more imaged will be saved when the disk is full. Loop Max Count means that after the image quantity is reached the number configured in Local Override Max. Count, the device will delete the first image and continue to save the latest image. Reserve Space means that the device will save images when the disk is safe in terms of storage space. If the available disk space is lower than configured value, and images will be deleted.

#### Local Override Max. Count

You need to set this parameter when selecting Max Count or Loop Max Count as Local Override Strategy.

#### Local Picture Name Content

It selects what contents you want to display in file name, including frame time, trigger No. and frame No.

#### Local Time Format

It selects a format type from the drop-down list for the time stamp contained in the file name. Take YYYYMMDD\_HHMMSSFFF as an example, (from the left to the right) YYYY represents year, MM represents month, DD represents date, HH represents hour, MM represents minute, SS represents second, and FFF represents millisecond.

#### Local Save Picture Strategy

It sets the picture saving method. Four methods are available, including recently frame, all frames, range frames and specific frame. If specific frame is selected as Local Save Picture Strategy, you need to set Local Picture Index.

### Result Output via FTP

The device also supports using the FTP communication protocol to send and receive data, and you can select it to output information. The configurable parameters below are related to the trigger mode, and here we take the external trigger mode as an example.



The configurable parameters may differ if the internal trigger mode is enabled.

#### Sorting Rules

It decides the output order of codes, and you can select it according to actual demands.

#### One By One Enable

If it is enabled, the device will send one piece of code information each time in accordance with the specified interval. You can set the interval via One By One Interval and the default value 100 ms.

#### Local Save Picture Mode

It includes Off and NoRead. You can select NoRead to let the device save images when no code is read.

#### Local Picture Type

It sets the image saving type, including JPEG and BMP.

## Code Reading Result Settings

### Local Override Strategy

It includes Off, Max Count, Loop Max Count, and Reserve Space. Off means that disk will not be overridden. Max Count means that the device will save image quantity configured in Local Override Max. Count, and no more imaged will be saved when the disk is full. Loop Max Count means that after the image quantity is reached the number configured in Local Override Max. Count, the device will delete the first image and continue to save the latest image. Reserve Space means that the device will save images when the disk is safe in terms of storage space. If the available disk space is lower than configured value, and images will be deleted.

### Local Override Max. Count

You need to set this parameter when selecting Max Count or Loop Max Count as Local Override Strategy.

### Local Picture Name Content

It selects what contents you want to display in file name, including frame time, trigger No. and frame No.

### Local Time Format

It selects a format type from the drop-down list for the time stamp contained in the file name. Take YYYYMMDD\_HHMMSSFFF as an example, (from the left to the right) YYYY represents year, MM represents month, DD represents date, HH represents hour, MM represents minute, SS represents second, and FFF represents millisecond.

### Local Save Picture Strategy

It sets the picture saving method. Four methods are available, including recently frame, all frames, range frames and specific frame. If specific frame is selected as Local Save Picture Strategy, you need to set Local Picture Index.

### Output Retrans Enable

If this parameter is enabled, the data is allowed to retransmit to FTP server, and you should set specific value in Output Retrans Number.



If data retransmission is still failed after the times allowed for data retransmission is reached, the retransmission will be discarded.

### FTP Picture Name Content

It selects what contents you want to display in FTP file name, including code content, code type, frame number, etc. You can select multiple contents as desired, and the selected contents will be displayed below.

### FTP Transmission Conditions

It sets the condition to upload the data outputted by the device to FTP server. All refers to upload the data always. Read Barcode refers to upload the data only when the barcode is read by the device. No Read Barcode refers to upload the data only when no barcode is read by the device.

### FTP Transmission Result Contain

It selects contents to upload to the FTP server. Just Result refers to only upload the content of the barcode. Just Picture refers to only upload the barcode picture. Result and Picture refers to upload both the content of the barcode and the picture.

### FTP Time Format

It selects a format type from the drop-down list for the time stamp contained in the file name. Take YYYYMMDD\_HHMMSSFFF as an example, (from the left to the right) YYYY represents year, MM represents month, DD represents date, HH represents hour, MM represents minute, SS represents second, and FFF represents millisecond.

### FTP Result Prefix

It sets the prefix of FTP file name, including No, Result and All. No stands for no prefix for file name, and all images are saved in FTP root directory. Result stands for all images that code reading successfully will be saved in Read directory, and all images that code reading failed will be saved in Noread directory. All stands for all images will be saved in All directory.

### FTP Save Picture Strategy

It sets the FTP picture saving method when no code is read. Four methods are available, including recently frame, all frames, range frames and specific frame. If specific frame is selected as FTP Save Picture Strategy, you need to set FTP Picture Index.

## Code Reading Result Settings

### Result Output via Other Communication Protocols

When the communication protocol is TCP Client, TCP Server, Serial, Profinet, Melsec, Ethernet/IP, ModBus, Fins or SLMP, device mode is Normal and trigger mode is On, you can set following parameters.



- The configurable parameters may differ if the internal trigger mode is enabled.
- Here we take Profinet as Communication Protocols as an example to introduce parameters. Regarding other communication protocols, the configurable parameters are similar with slight difference in term of parameter names., and refer to the actual device you got for details.

#### Sorting Rules

It decides the output order of codes, and you can select it according to actual demands.

#### One By One Enable

If it is enabled, the device will send one piece of code information each time in accordance with the specified interval. You can set the interval via One By One Interval and the default value 100 ms.

#### ROI Output NoRead Enable

If it is enabled, codes will be outputted in turn according to the ROI Selector of the algorithm ROI they belong.

#### Local Save Picture Mode

It includes Off and NoRead. You can select NoRead to let the device save images when no code is read.

#### Local Picture Type

It sets the image saving type, including JPEG and BMP.

#### Local Override Strategy

It includes Off, Max Count, Loop Max Count, and Reserve Space. Off means that disk will not be overridden. Max Count means that the device will save image quantity configured in Local Override Max. Count, and no more imaged will be saved when the disk is full. Loop Max Count means that after the image quantity is reached the number configured in Local Override Max. Count, the device will delete the first image and continue to save the latest image. Reserve Space means that the device will save images when the disk is safe in terms of storage space. If the available disk space is lower than configured value, and images will be deleted.

#### Local Override Max. Count

You need to set this parameter when selecting Max Count or Loop Max Count as Local Override Strategy.

#### Local Picture Name Content

It selects what contents you want to display in file name, including frame time, trigger No. and frame No.

#### Local Time Format

It selects a format type from the drop-down list for the time stamp contained in the file name. Take YYYYMMDD\_HHMMSSFFF as an example, (from the left to the right) YYYY represents year, MM represents month, DD represents date, HH represents hour, MM represents minute, SS represents second, and FFF represents millisecond.

#### Local Save Picture Strategy

It sets the picture saving method. Four methods are available, including recently frame, all frames, range frames and specific frame. If specific frame is selected as Local Save Picture Strategy, you need to set Local Picture Index.

#### Profinet Output Format

It selects what contents you want to output, including code content, code type, angle, trigger start time, code score, etc. You can select multiple contents according to actual demands.

#### Profinet Format Check

You should click Execute in Profinet Format Check to check if you entered is right in format, and the check result will be displayed in Profinet Format Check Result.

#### Profinet Output NoRead

If it is enabled, and the device will output the content you set in Profinet Output NoRead Text when no code is recognized.

#### Profinet Output Start Text

The contents of the start part of the data outputted. You can set the contents according to actual condition.

#### Profinet Output Stop Text

The contents of the end part of the data outputted. You can set the contents according to actual condition.

#### Profinet Output Barcode Enter Character Enable

If it is enabled, enter character will be outputted.

#### Profinet Output Barcode Newline Character Enable

If it is enabled, a newline will be outputted.

#### Profinet Output Barcode Carriage Return Enable

If it is enabled, a carriage return will be outputted.

---

## Code Reading Result Settings

---

### **Profinet Add NoRead Enable**

You can add contents to let the device output codes when the code recognized by the device does not meet the min. length requirement. It includes Off, Add Noread, and Just Noread. Off does not add contents and the device outputs code recognized only. Add Noread allows you to add contents to the min. length requirement and output. Just Noread means that the device outputs Noread only if the code recognized by the device does not meet the min. length requirement.

### **Code Pos Width Enable**

If it is enabled, you can add 0 to codes if the code coordinate does not meet specified length.

### **Code Pos Width**

You can enter the length of the code coordinate after enabling Code Pos Width Enable.

### **CodeNum End Trigger Min**

If it is enabled, the device will stop triggering and save the current image when the code recognized by the device does not meet the min. length requirement.

## Contrast Control Settings



You need to set device mode as Normal before using this function.

The contrast control function compares the data that the device reads with preset data and outputs contrast result. The result can be used as the event source of trigger signal, including Contrast Success and Contrast Fail. This function has two ways to contrast, including regular contrast and consecutive number contrast.

### Regular Contrast

The regular contrast requires you to set code contents in advance, and the client software will contrast the data that the device reads with preset contents and outputs comparison result.

#### Steps

- 1.Right click the device in Device Connection, and click Feature Tree.
- 2.Go to Contrast Control, enable Contrast Enable, and select Regular as Contrast Rules.
- 3.Set Start Position that means the stating position of the comparison.
- 4.Set Character Number that means the comparison quantity.
- 5.Set code contents in Wildcard String.



You can use wildcard \* and ?. \* stands for multiple strings you can use, and ? stands for one string you can use. \* can be used once only and ? can be used many times.

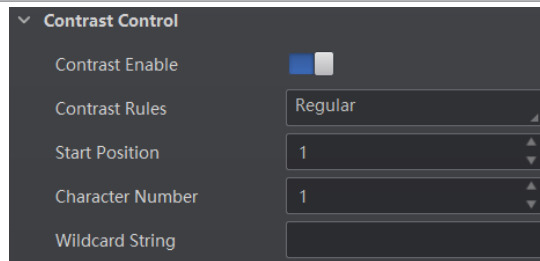

### Consecutive Number Contrast

The consecutive number contrast requires you to set consecutive code rules, and the client software will contrast the data that the device reads with preset rules and outputs contrast result.

#### Steps

- 1.Right click the device in Device Connection, and click Feature Tree.
- 2.Go to Contrast Control, enable Contrast Enable, and select Consecutive Number as Compare Rules.
- 3.Set Start Position that means the stating position of the comparison.
- 4.Set Digital Number that means the comparison quantity.
- 5.Set Step that means the client software will increase or decrease the preset value after each comparison according the step you set.



- If the preset value after increase or decrease exceeds the digital number you set, and then the preset value will become 0.
- The base value displays the preset value.

6. (Optional) Click Execute in Contrast Reset to reset comparison. After that, the client software will use the first code it reads as the preset value.

Here we take start position (3), digital number (2) and step (2) as an example to explain the consecutive number comparison:

- If the first code that the device reads is ur96k, and then the preset value is 96. The preset value increases to 98 (96+2).
- If the second code is yr98kjkfd, and comparison succeeds. The preset value increases to 100 (98+2).
- If the third code is kl99fjkd, and comparison fails. The preset value does not increase.
- If the fourth code is kl00djf, and comparison succeeds. The preset value increases to 02 (00+2).

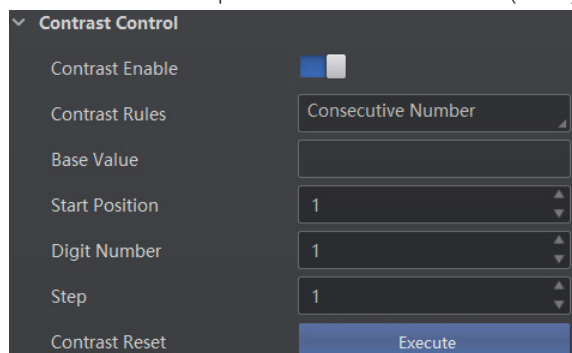

## Communication Settings

The communication protocol is used to transmit and output code reading result and image. The communication protocol is related to the device modes. With various device modes, the device supports different communication protocols and corresponding parameters. When the device mode is Test or Raw, the device only supports Smart SDK protocol and no parameter settings are required. While in Normal mode, the device supports Smart SDK, TCP Client, TCP Server, Serial, FTP, Profinet, Melsec, Ethernet/IP, ModBus, Fins and SLMP communication protocols, and you need to set corresponding parameters.



The specific communication parameters may differ by device models and firmware.

### Smart SDK

If Smart SDK is selected as the Communication Protocols, you can enable SmartSdk Protocol to let the device output data via Smart SDK.

#### Encode JPG Flag

If enabled, the device will compress the image data.

#### Quantity of Jpg

You can enter a number (range: 50 to 99) to determine the compression quality

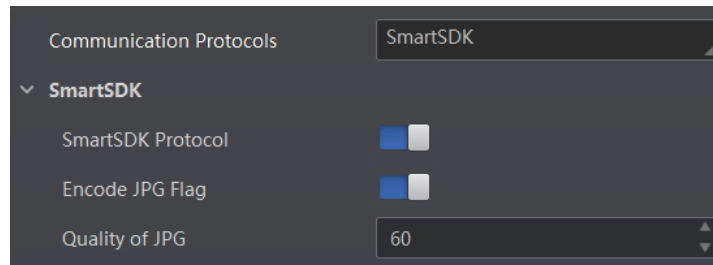

### TCP Client

The TCP includes TCP Server and TCP Client. If TCP Client is selected as the Communication Protocols, you can enable TCP Protocol, and enter TCP Dst Addr and TCP Dst Port.

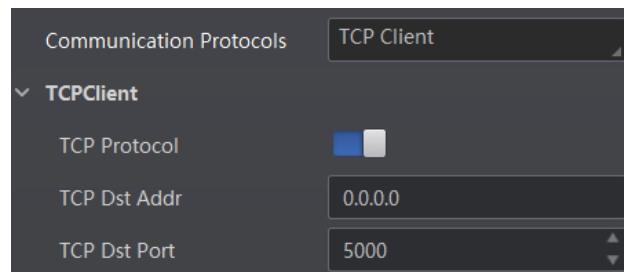

### TCP Server

The TCP includes TCP Server and TCP Client. If TCP Server is selected as the Communication Protocols, you can enable TCP Server Enable, and enter TCP Server Port.

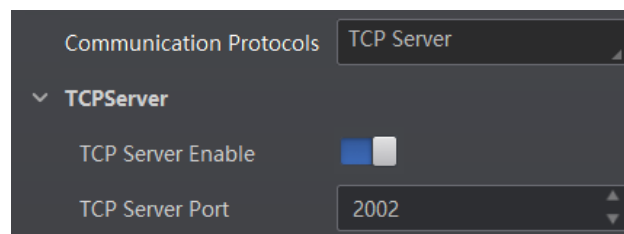



## Communication Settings

### Serial

If Serial is selected as the Communication Protocols, you can enable Serial Protocol, enter Serial Baud Rate, Serial Data Bits, Serial Parity, and Serial Stop Bits.

Communication Protocols	Serial
Serial Protocol	<input checked="" type="checkbox"/>
Serial Baudrate	9600
Serial Data Bits	8
Serial Parity	NoParity
Serial Stop Bits	1

### FTP

If FTP is selected as the Communication Protocols, you can enable FTP Protocol, enter FTP Host Addr, FTP Host Port, FTP User Name, and FTP User PWD.

Communication Protocols	FTP
FTP Protocol	<input checked="" type="checkbox"/>
FTP Host Addr	0.0.0.0
FTP Host Port	21
FTP User Name	
FTP User PWD	

### Profinet

If Profinet is selected as the Communication Protocols, you can enable Profinet Enable and set Profinet Device Name according to actual demands.

Communication Protocols	Profinet
Profinet Enable	<input checked="" type="checkbox"/>
Profinet Device Name	

### MELSEC

If MELSEC is selected as the Communication Protocols, you can enable MELSEC Protocol Enable and set related parameters according to actual demands.

#### MELSEC Destination Address

It sets the IP address of the target PLC.

#### MELSEC Destination Port

It sets the port number of the target PLC.

#### MELSEC Data Base Address

It sets the first address of the data area.

#### MELSEC State Base Address

It sets the first address of the status area.

#### MELSEC Network Number

It sets the network No.

## Communication Settings

### MELSEC PLC Number

It sets the PLC No.

### MELSEC Module I/O Number

It sets the target module's I/O number.

### MELSEC Module Station Number

It displays the module station number.

### MELSEC Timeout

It sets the waiting time before the returning of PLC's response.

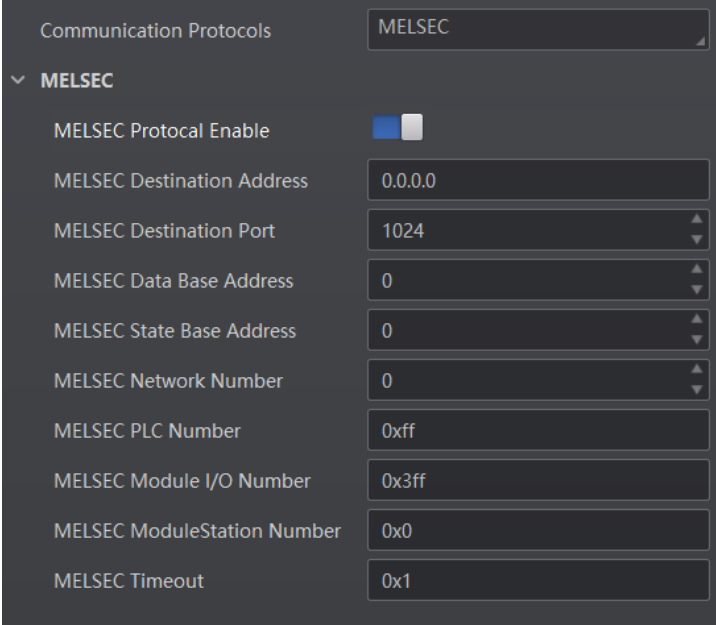

## ■ Ethernet/IP

If Ethernet/IP is selected as the Communication Protocols, you can enable Ethernet/IP Enable, and the device will output data via Ethernet/IP.

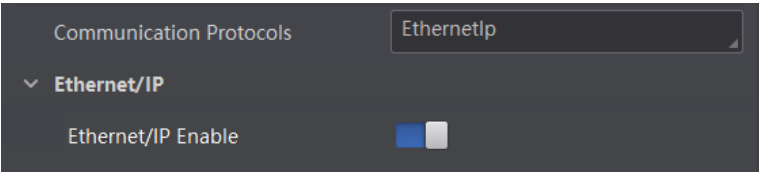

## ■ ModBus

If ModBus is selected as the Communication Protocols, you can enable ModBus Enable and set related parameters according to actual demands.

### ModBus Mode

It includes server and client, and is server by default.



If client is selected as ModBus Mode, you need to set ModBus Server IP, ModBus Server Port and ModBus Scan Rate (ms).

### ModBus Control Address Space

It is holding\_register by default.

### ModBus Control Address Offset

It refers to the address offset, and is 0 by default.

### ModBus Control Data Number

It is 2 by default.

### ModBus State Address Space

It is input\_register by default.

## Communication Settings

### ModBus State Address Offset

It is 0 by default.

### ModBus State Data Number

It is 2 by default.

### ModBus Result Address Space

It is input\_register by default.

### ModBus Result Address Offset

It is 4 by default.

### ModBus String Byte Swap

If it is enabled, string byte is saved by big-endian. If it is not enabled, string byte is saved by little-endian.

The screenshot shows a configuration window for ModBus. The 'Communication Protocols' dropdown is set to 'ModBus'. Under the 'ModBus' section, the following settings are visible:

- ModBus Enable:** A toggle switch that is currently turned on (blue).
- ModBus Mode:** A dropdown menu set to 'server'.
- ModBus Control Address Space:** A dropdown menu set to 'holding\_register'.
- ModBus Control Address Offset:** A numeric input field set to '0'.
- ModBus Control Data Number:** A numeric input field set to '2'.
- ModBus State Address Space:** A dropdown menu set to 'holding\_register'.
- ModBus State Address Offset:** A numeric input field set to '2'.
- ModBus State Data Number:** A numeric input field set to '2'.
- ModBus Result Address Space:** A dropdown menu set to 'holding\_register'.
- ModBus Result Address Offset:** A numeric input field set to '4'.
- ModBus String Byte Swap:** A toggle switch that is currently turned off (grey).

## ■ Fins

If Fins is selected as the Communication Protocols, you can enable Fins Enable and set related parameters according to actual demands.

### Fins Communication Mode

It includes UDP or TCP.

### Fins Local Port

It is 9600 by default.

### Fins Dst IP

It sets the IP address of the target device.

### Fins Dst Port

It sets the port of the target device.

### Fins Data Format

It includes 16-bit or 32-bit.

### Fins Scan Rate (ms)

It sets the interval that the device reads the server's control register, and the unit is ms.

### Fins Control Area

It is saved in DM area by default.

### Fins Control Addr

You can set it according to actual demands. Make sure that each area cannot be overlapped and covered.

### Fins State Area

It is saved in DM area by default.

### Fins State Addr

You can set it according to actual demands. Make sure that each area cannot be overlapped and covered.

## Communication Settings

### Fins Result Area

It is saved in DM area by default.

### Fins Result Addr

You can set it according to actual demands. Make sure that each area cannot be overlapped and covered.

Communication Protocols	Fins
<b>▼ Fins</b>	
Fins Enable	<input checked="" type="checkbox"/>
Fins Communication Mode	UDP
Fins Local Port	9600
Fins Dst IP	0.0.0.0
Fins Dst Port	9600
Fins Data Format	16 bit
Fins Scan Rate(ms)	30
Fins Control Area	DM Area
Fins Control Addr	0
Fins State Area	DM Area
Fins State Addr	2
Fins Result Area	DM Area
Fins Result Addr	4

## ■ SLMP

If SLMP is selected as the Communication Protocols, you can enable SLMP Enable and set related parameters according to actual demands.

### SLMP Dst Addr

It sets the IP address of the target PLC.

### SLMP Dst Port

It sets the port number of the target PLC.

### SLMP Data Base Addr

It sets the first address of the data area.

### SLMP State Base Addr

It sets the first address of the status area.

### SLMP Network Num

It sets the network No.

### SLMP PLC Num

It sets the PLC No.

### SLMP Module I/O Num

It sets the target module's I/O number.

### SLMP Module Station Num

It displays the module station number.

### SLMP Timeout

It sets the waiting time before the returning of PLC's response.

Communication Protocols	SLMP
<b>▼ SLMP</b>	
SLMP Enable	<input checked="" type="checkbox"/>
SLMP Dst Addr	0.0.0.0
SLMP Dst Port	23
SLMP Data BaseAddr	0
SLMP State BaseAddr	0
SLMP Network Num	0
SLMP PLC Num	0xff
SLMP Module I/O Num	0x3ff
SLMP Module Station Num	0x0
SLMP Timeout	0x1

## User Set Customization

The Configuration Management module allows you to set and manage the user set. A user set is a group of parameter values with all the settings needed to control the device, and you can save, load and switch different user sets.

### Save Settings

If you have set the device parameters as desired, you can save them into the user set. Go to Config Management → Save Settings, and click UserSet1, UserSet2, or UserSet3 to save the current device settings.

### Load Settings

You can load the user set to restore the device to the saved group of parameter values again if required. Go to Config Management → Load Settings, and click Default, UserSet1, UserSet2, or UserSet3 to load settings.



The Default refers to restore the device parameter settings to the factory ones.

### Start Settings

The selected user set will be automatically loaded after the device being powered on. For example, if you select Default, the device parameter settings will be restored to the factory settings.

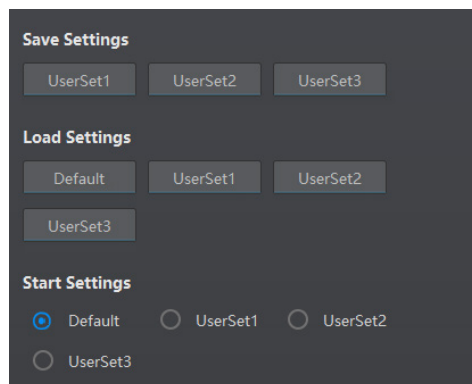

## Statistics Information

The statistics information in the feature tree helps you to count data related with code reading.



You need to set device mode as Normal before using this function.

Go to feature tree, find Statistics Info., and select Statistics Mode according to actual demands. Two statistics modes are available: All Frames means that the client software will display all data since the device is powered on. Latest Frames means that the client software will display data of the last 10 frames. Refer to the table below for specific parameters.

Parameter Name	Description
Total Frame Number	The total frame quantity.
Read Frame Number	The quantity of frames that have been read codes.
Noread Frame Number	The quantity of frames that have not been read codes.
Read Rate	It refers to the code reading ratio.
Algo Time Ave.	The average time of algorithm, and the unit is ms.
Algo Time Max.	The max. time of algorithm, and the unit is ms.
Algo Time Min.	The min. time of algorithm, and the unit is ms.
Read Time Ave.	The average time of code reading, and the unit is ms.
Read Time Max.	The max. time of code reading, and the unit is ms.
Read Time Min.	The min. time of code reading, and the unit is ms.
Reset Statistics	Click Execute to reset statistics information.

The screenshot shows the 'Statistics Info' panel with the following parameters and values:

- Statistics Mode: All Frames
- Total Frame Number: 0
- Read Frame Number: 0
- Noread Frame Number: 0
- Read Rate: 0
- Algo Time Ave: 0
- Algo Time Max: 0
- Algo Time Min: 0
- Read Time Ave: 0
- Read Time Max: 0
- Read Time Min: 0
- Reset Statistics: Execute

## Event Report

The diagnose event report function in the feature tree monitors memory and CPU usage rate, and let you know when there is a crash, higher CPU usage rate, insufficient memory, and other events.

Go to feature tree, find Diagnose Event Report, and you can view related information as shown below. You can click Execute in Reset Event to clear all information.

The screenshot shows the 'Diagnose Event Report' panel with the following details:

- Event Code: 0x30000004
- Event Name: MemoryOver
- Event Report Time: 20201124\_152610691
- Event Detail: { "FreeMem" : 18,
- Reset Event: Execute

## CHAPTER 5 DEVICE OPERATION

The device operation section introduces some basic device operations about how to start live view, acquisition and recording, add cross line in the image, split window, view reports, etc.



Connecting the device to the client software is required before device operation.

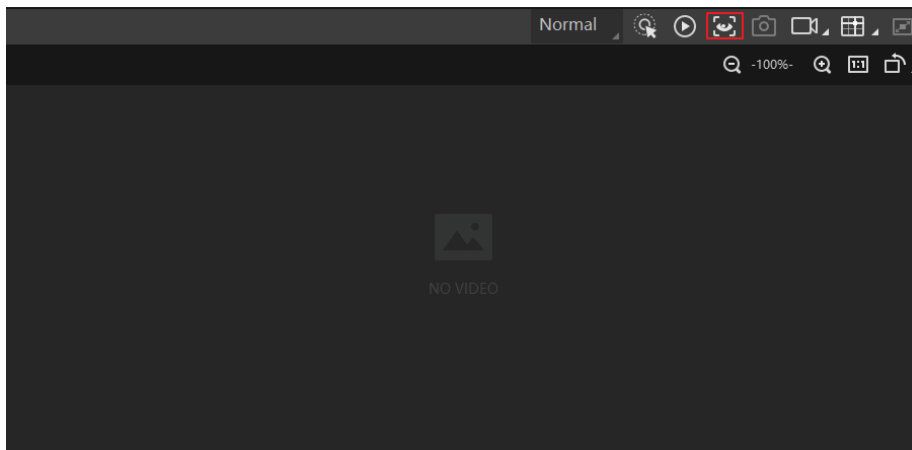

### Live View

You can view the real-time image in the live view window. Click  in live view window to start live view, or click  to stop.



### Enable Acquisition

Enabling acquisition allows the device to acquire the real-time stream.

Click  in live view window to start acquisition, or click  to stop. You can also right click the device on the device list, and click Stop Acquisition to stop acquiring streams.



Acquisition is still going on if you only stop live view.

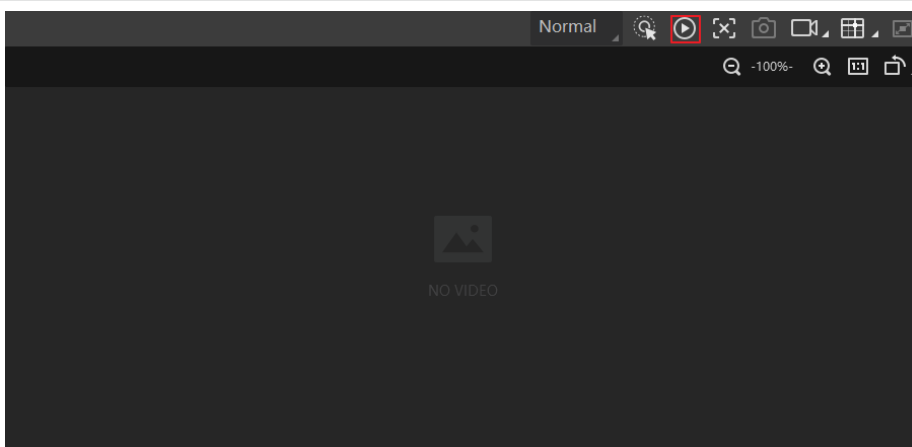

## Add Cross Line

During live view, you can add a cross line on the live view image to adjust the position of the object in the view.

Click  in live view window to add cross line, and click  (beside ) to open the editing window to set cross line parameters.

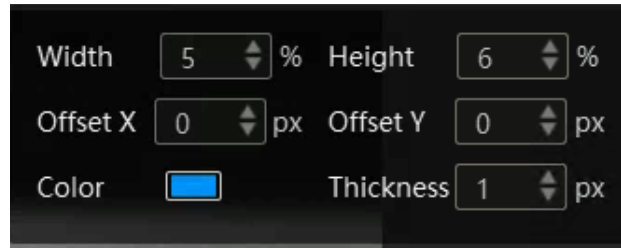





## Start Recording

During live view, you can record video files and capture images continuously.



Enabling acquisition is required before recording.

Click  in live view window to start recording, and click the icon again to stop. You can also click  (beside ) , and then click  to capture images of the live view continuously.

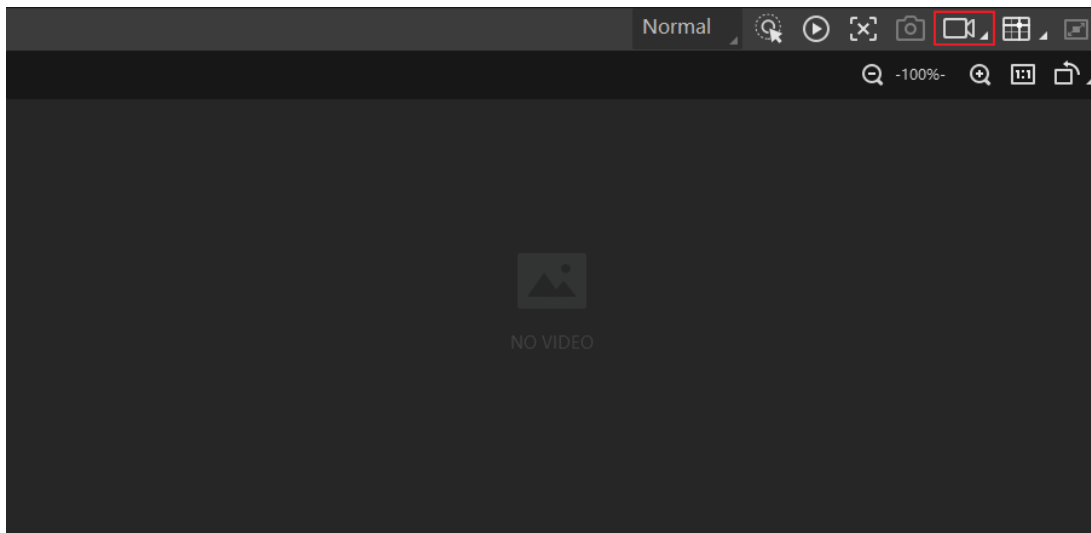

## Split Window

The client software supports window division function that allows you to split the window into multiple-window mode to view the live view of multiple devices at the same time. Click  in control toolbar to select window division mode. You can click Custom to customize window division as you desired.

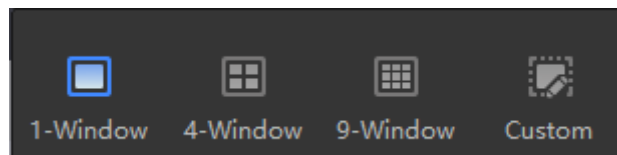

## View Reports

During acquisition or live view, you can view the reading status of the device.

Click  in control toolbar to open the statistics window to view the detailed information. Read Code Images refers to the number of the images on which the barcodes are read by the device. Unread Code Images refers to the number of the images on which the barcodes are not read by the device. Read Rate refers to the code reading rate.



## View Log

You can view the device logs and export them to the local PC.

Click  in control toolbar to open the device log window, and you can view different types of logs, including device errors, warning, and informational log, etc.

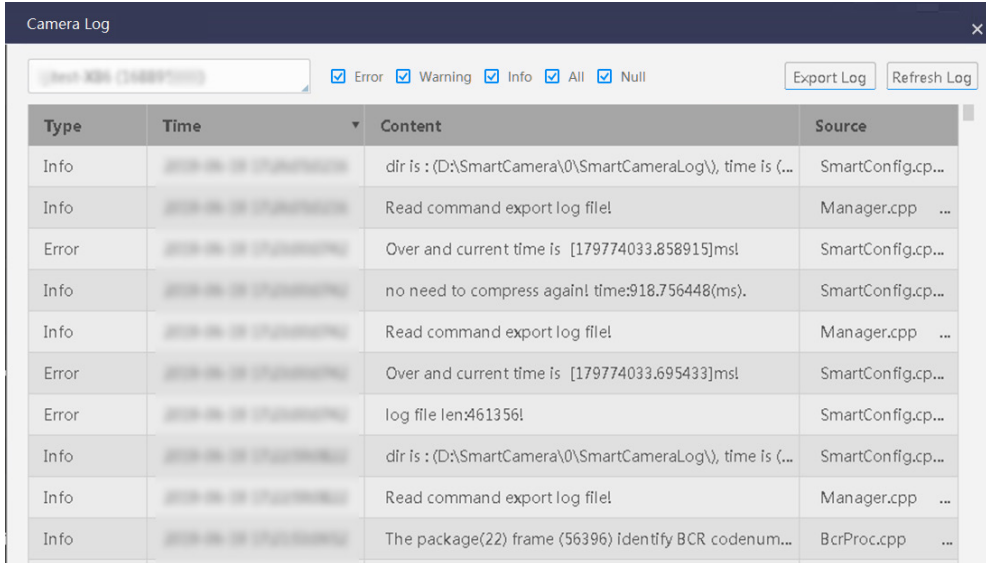

Type	Time	Content	Source
Info	2019-06-28 10:00:00.000	dir is : (D:\SmartCamera\0\SmartCameraLog\), time is (...	SmartConfig.cp...
Info	2019-06-28 10:00:00.000	Read command export log file!	Manager.cpp ...
Error	2019-06-28 10:00:00.000	Over and current time is [179774033.858915]ms!	SmartConfig.cp...
Info	2019-06-28 10:00:00.000	no need to compress again! time:918.756448(ms).	SmartConfig.cp...
Info	2019-06-28 10:00:00.000	Read command export log file!	Manager.cpp ...
Error	2019-06-28 10:00:00.000	Over and current time is [179774033.695433]ms!	SmartConfig.cp...
Error	2019-06-28 10:00:00.000	log file len:461356!	SmartConfig.cp...
Info	2019-06-28 10:00:00.000	dir is : (D:\SmartCamera\0\SmartCameraLog\), time is (...	SmartConfig.cp...
Info	2019-06-28 10:00:00.000	Read command export log file!	Manager.cpp ...
Info	2019-06-28 10:00:00.000	The package(22) frame (56396) identify BCR codenum...	BcrProc.cpp ...

## Set Time

After enabling NTP time synchronization, the device will synchronize time according to the configured interval.

### Steps

- 1.Go to Config Management, and find Timing.
- 2.Click Setting and enable NTP Enable.
- 3.Set parameters according to actual demands.



Configure NTP server settings before using NTP time synchronization function.

4. Click OK after settings.

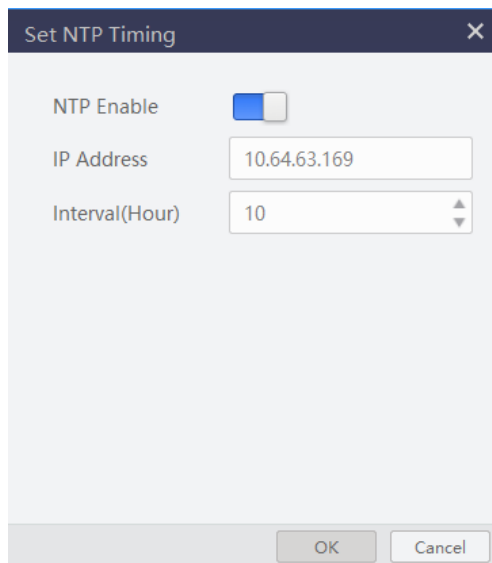

Set NTP Timing

NTP Enable

IP Address

Interval(Hour)

OK Cancel

## Enable Device Auto Work

This function allows the device to automatically enter the operating status after being powered on.

You can go to Config Management → Device Auto Work Enable, and enable Device Auto Work Enable.

Device Auto Work Enable



## CHAPTER 6 I/O WIRING

### Input Signal

The device's LineIn 0/1/2 are input signals, and their internal circuit is as follows.



- The maximum input current of input signal is 25 mA.
- The breakdown voltage is 36 VDC. Keep voltage stable.

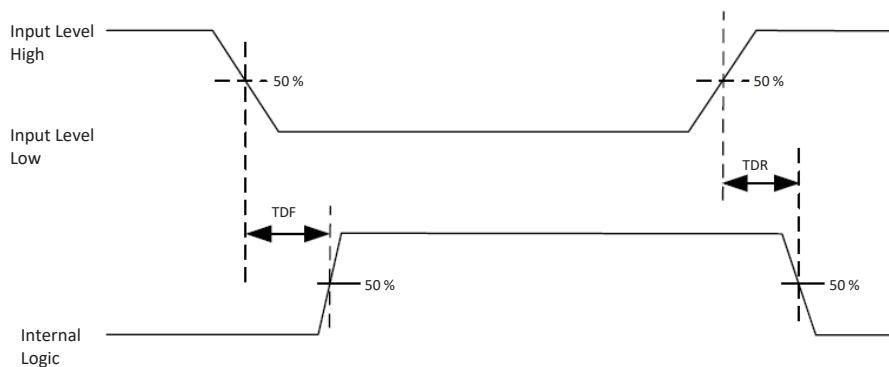
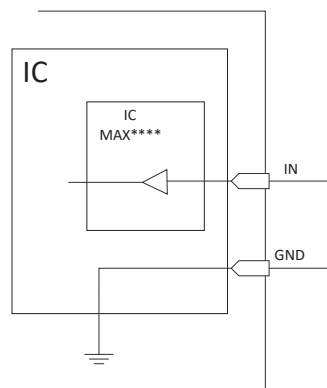

Input Electrical Feature:

Parameter Name	Parameter Symbol	Value
Input Logic Level Low	VL	0 ~ 9 VDC(VCC=24 V) 0 ~ 5.4 VDC(VCC=12 V)
Input Logic Level High	VH	11 ~ 24 VDC(VCC=24 V) 7.56 ~ 12 VDC(VCC=12 V)
Input Rising Delay	TDR	1.3 ~ 3.5 $\mu$ s
Input Falling Delay	TDF	1.3 ~ 3.5 $\mu$ s



VCC stands for Volt Current Condenser, and it is the device's input voltage.

## Output Signal

The device's LineOut 0/1/2 are output signals, and their internal circuit is as follows.



The maximum output current of output signal is 200 mA.

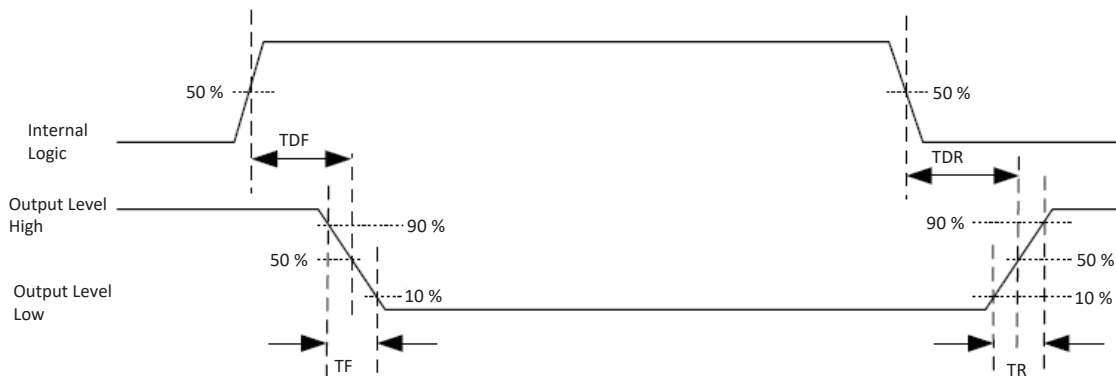
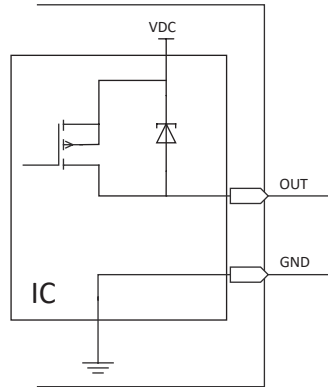

When the external voltage and resistance is 12 VDC and 1 k $\Omega$  respectively, output electrical feature is as follows.



If the external voltage and resistance change, the corresponding current of output signal and output logic level low may differ.

Parameter Name	Parameter Symbol	Value
Output Logic Level Low	VL	212 mV
Output Logic Level High	VH	11.8 V
Output Rising Time	TR	0.4 $\mu$ s
Output Falling Time	TF	0.4 $\mu$ s
Output Rising Delay	TDR	0.4 $\mu$ s
Output Falling Delay	TDF	0.4 $\mu$ s

## Input Signal Wiring

The device can receive the external input signal via I/O interface, and here we take LineIn 0 as an example to introduce input signal wiring.



Input signal wiring may differ by external device types.

### ■ PNP Device



It is recommended to use 330  $\Omega$  pull-down resistor.

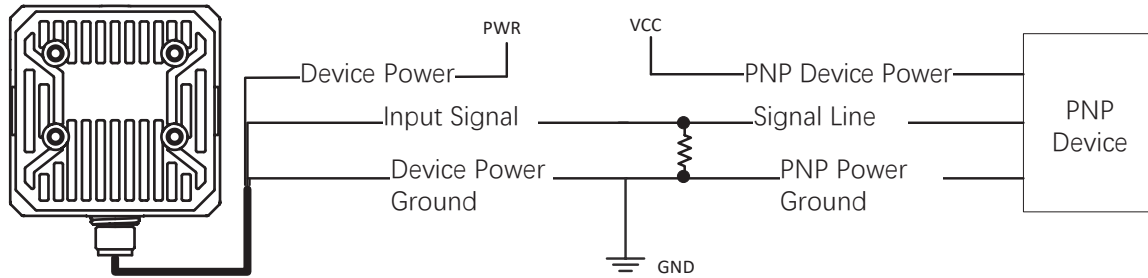

### ■ NPN Device



If the VCC of NPN device is 12 VDC or 24 VDC, and it is recommended to use 1 K $\Omega$  pull-up resistor.

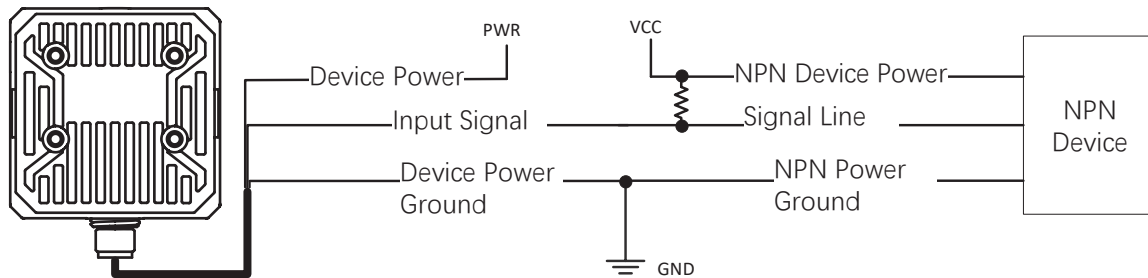

### ■ Switch



It is recommended to use 330  $\Omega$  pull-down resistor.

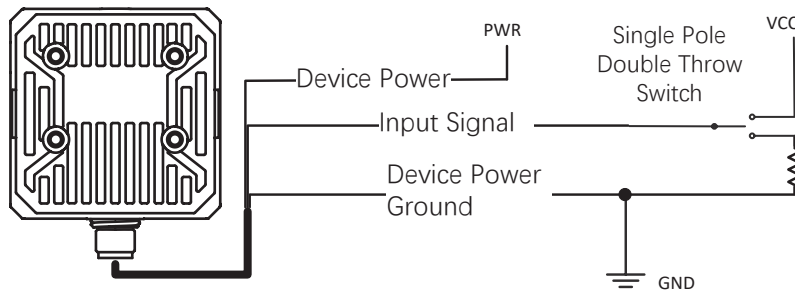

## Output Signal Wiring

The device can output signal to external devices via I/O interface, and here we take LineOut 0 as an example to introduce output signal wiring.



- Output signal wiring may differ by external device types.
- The voltage of VCC should not higher than that of PWR. Otherwise, the device's output signal may have exception.

### ■ PNP Device



It is recommended to use 330  $\Omega$  pull-down resistor.

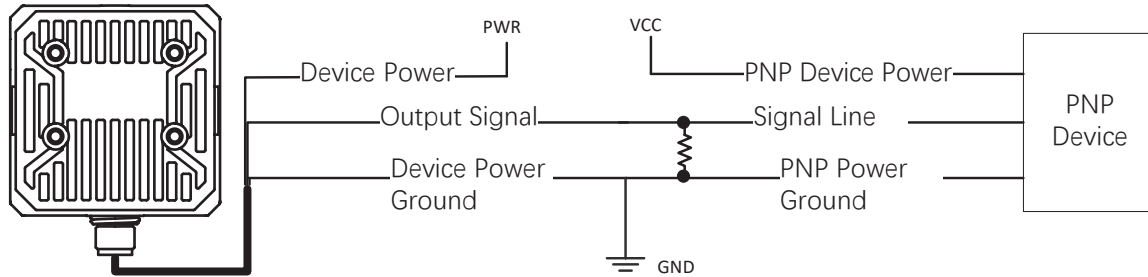

### ■ NPN Device



If the VCC of NPN device is 12 VDC or 24 VDC, and it is recommended to use 1 K $\Omega$  pull-up resistor.

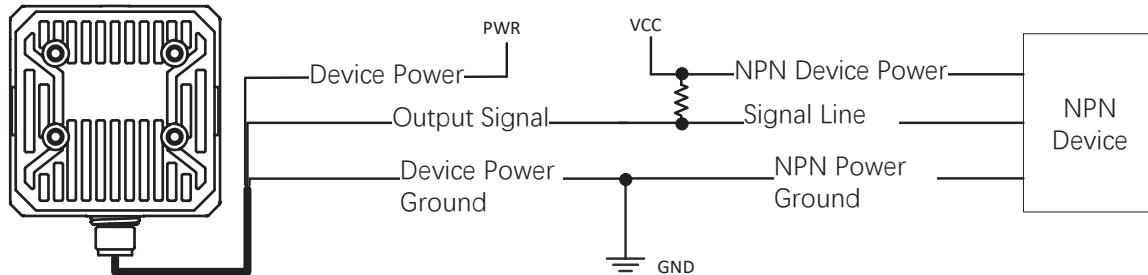

## RS-232 Serial Port

The 9-pin male connector and 25-pin male connector are commonly used serial ports, as shown below. You can refer to the table below for the specific pin name and function.

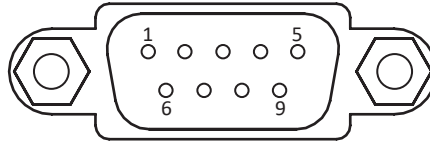

Pin No.	Name	Function
2	RX	Receive data
3	TX	Send data
5	GND	Signal ground

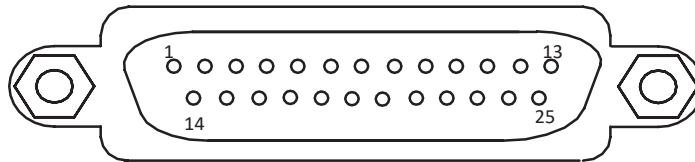

Pin No.	Name	Function
2	TX	Send data
3	RX	Receive data
7	GND	Signal ground

### ■ RS-232 Serial Port Wiring

You can refer to the serial port wiring below to connect the device with an external device.

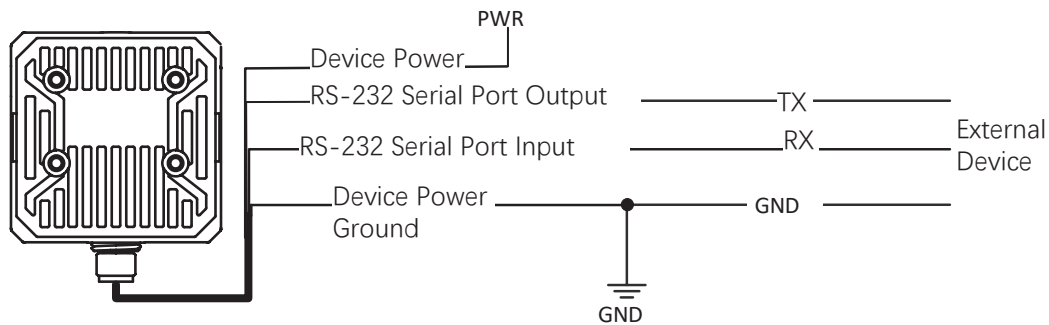

## CHAPTER 7 OTHER FUNCTIONS

### Trouble Shooting

PROBLEM	Reason	Solution
Run client, there is no listed device.	The device is powered off.	Check the device power connection (observe whether the top PWR light is solid green or not), to make sure the device is powered up normally.
	Network exception.	Check the network connection (observe whether the top LNK light is flashing green or not), to make sure the device can be connected to the network normally. PC port and the device are in the same network segment.
All black or too dark during preview.	Insufficient brightness of supplement light.	Increase the brightness of supplement light appropriately, or change to a brighter one. Increase exposure and gain appropriately.
	Too small adjustment value of exposure and gain.	Increase exposure and gain appropriately.
	The polarization lens cap may be used.	The brightness of polarization lens cap is low, and it is not recommended to use it in normal condition.
Image incoherent/Low frame rate/ Image tearing when adjusting the view preview.	Network circuitry speed is not 100 Mbps.	Check whether network transit speed is 100 Mbps or not.
No image in the live view.	Enabled trigger mode, but there is no trigger signal.	Sent the trigger signal to the device/Disable the trigger mode.
	Network circuitry speed is not 100 Mbps.	Check whether network circuitry speed is 100 Mbps or not.

## CHAPTER 8 TECHNICAL SUPPORT

If you need advice about your camera or if you need assistance troubleshooting a problem with your camera, it's highly recommended to describe your issue in details and contact us via E-mail at [support@contrasttech.com](mailto:support@contrasttech.com)

It would be helpful if you can fill-in the following table and send to us before you contact our technical support team.

Model:		SN:	
Describe the issue in as much detail as possible:			
If known, what's the cause of the issue?			
How often did/does the issue occur?			
How severe is the issue?			
Parameter set			

### Hangzhou Contrastech Co., Ltd

No.8 Xiyuan 9th Road, West Lake District Hangzhou Zhejiang 310030  
 China  
 Tel: 86-571-89712238  
[www.contrasttech.com](http://www.contrasttech.com)

For Research Use Only ©2023 Hangzhou Contrastech Co., Ltd.  
 All rights reserved. All trademarks are the property of Hangzhou Contrastech Co., Ltd.