

- 0.4MP @125.2 fps
- Adopts GigE interface and max. transmission distance of 100 meters without relay
- Compatible with GigE Vision Protocol, GenICam Standard, and the third-party software based on these protocol and standard.
- Support Windows、Linux
- Up to 128 MB local memory for burst transmission and retransmission



Applied range • Defect Detection • Surface Patch Detection • Visual Positioning • Size Measuring • QR Code Reading • VR/AR • Logistics

Camera	LEO2 720S-125gm/gc
Resolution [H*V]	720 × 540
Sensor	Sony IMX297
Sensor Size	1/2.9"
Sensor Technology	Global, CMOS
Pixel Size [μm]	6.9 × 6.9
Frame Rate [fps]	125.2
Data Bit	8bit / 10bit / 12bit
Exposure Time	15μs~10s
Dynamic Range	74dB
Mono/Color	Mono/Color
Image Format	Monochrome: Mono8/10/10p/12/12p Color: Mono 8/10/12,Bayer RG 8/10/10p/12/12p, YUV422Packed,YUV422_YUYV_Packed,RGB 8,BGR8
Interface	GigE
Synchronization	Via hardware trigger、software trigger or free run mode
Programmable Control [ISP]	Image resolution、RGB gain、Exposure time、Contrast ratio、Gamma form、Image rollovers、Raw、LUT、Black level correction
Housing Size [l*w*h]	29.0 × 29.0 × 42.0 mm (100g)
Operating Temperature	-30~70 ° C (Storage), -30~60° C (Working)
Lenses Mount	C-Mount
Digital I/O	Opto-isolated input x 1, opto-isolated output x 1, and bi-directional custom non-isolated I/O x 1
Power Input	DC 9-24V, Supporting PoE
Power Consumption	Monochrome: 12V @2.2W Color: 12V @2.5W
Driver	LEO Series Camera Software Suite (iDatum) or 3rd party GigE Vision Software
Operating System	Windows, Linux
Conformity	GigE Vision, GenICam

Spectral Response

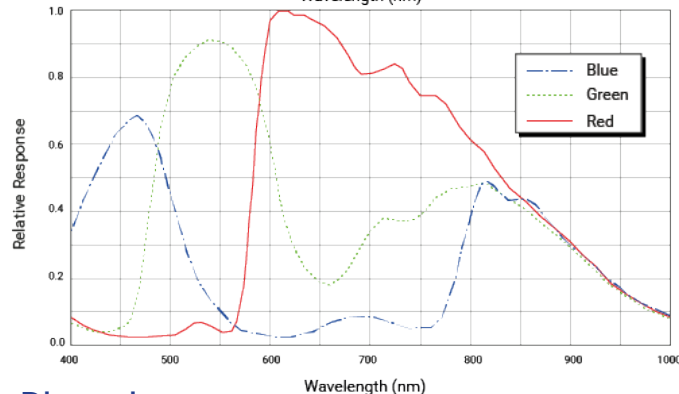
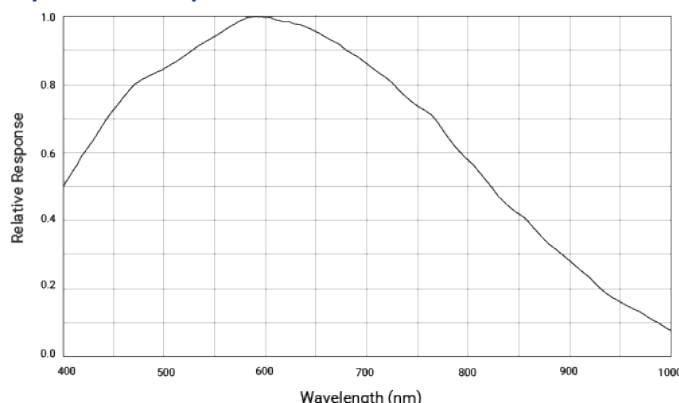

Dimensions

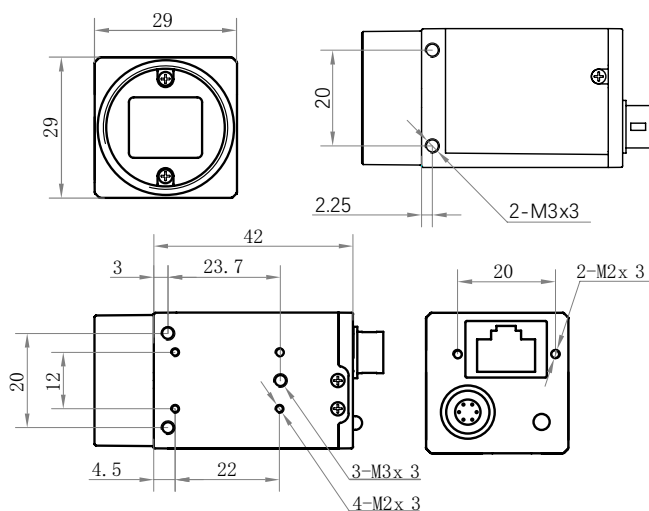

No.8, Xiyuan 9th Road West Lake District, Hangzhou 310030 China
Tel: 86-571-89712238 Web: www.contrastech.com
Email: market@contrastech.com