

# CLW2-3D SERIES

---

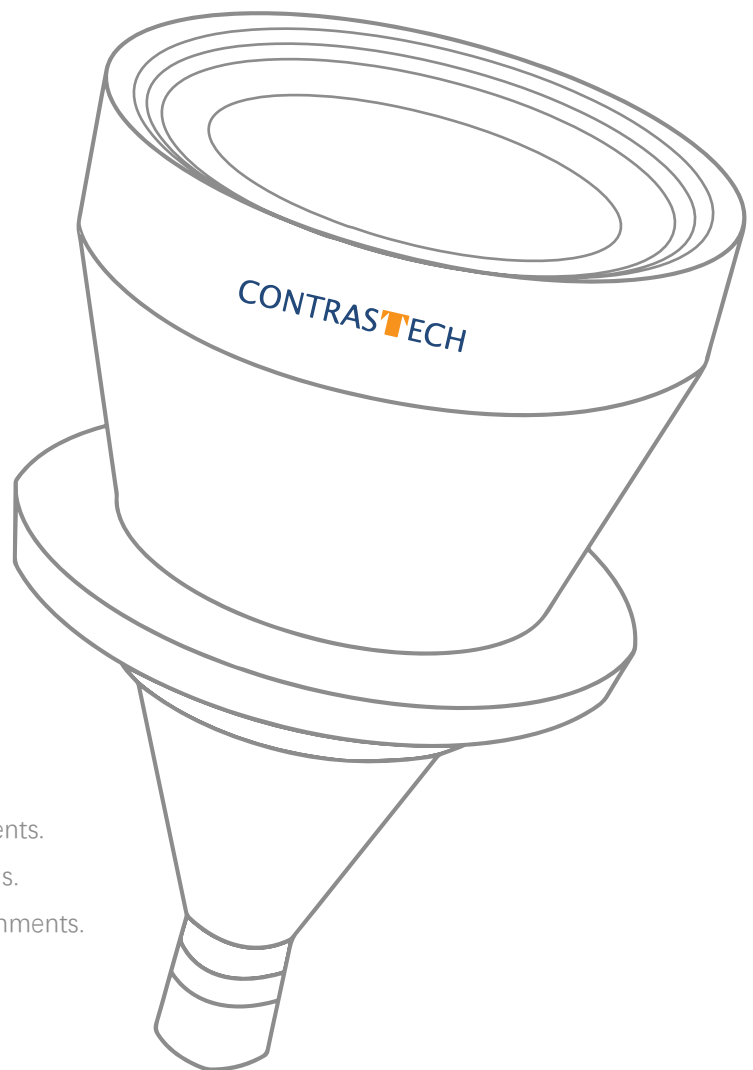

## MAIN FEATURES

- ◆ **High telecentricity** for thick object imaging.
- ◆ **Nearly zero distortion** for accurate measurements.
- ◆ **Excellent resolution** for high resolution cameras.
- ◆ **Simple and robust design** for industrial environments.

# ABOUT US

---

Hangzhou Contrastech Co., Ltd. is a leading imaging technology company with 20+ years of expertise in machine vision, optical imaging, and intelligent data processing.

Our flagship telecentric lenses, together with 360° telecentric lenses and telecentric light sources, deliver distortion-free imaging and precise measurement, with stable illumination for advanced automation and inspection.

Beyond standard products, we provide customized optical solutions—including infrared, ultraviolet, and multispectral designs—to tackle the most demanding applications.

Today, Contrastech telecentric technology powers leading-edge AI vision systems worldwide, enabling high-precision inspection, intelligent recognition, and reliable data acquisition. By combining world-class performance with optimized cost control, we help customers cut costs by 30–50% while achieving top-tier performance and efficiency.

# CLW2-3D SERIES

**NEW**



1. Chromatic Aberration Correction
2. Built-in Coaxial Illumination
3. Supports 3D AOI

Model No.	Variable Iris	Coaxial	FOV (Φmm)	Mag. (x)	WD (mm)	Max. Sensor Size (Φmm)	F/#	MTF30 (lp/mm)	DOF (mm)	Distortion (% max)	Telecentricity (° max)	Length (mm)	Mount
CLW2-3D-0.25X-240-H1.2(IA)	Yes	No	80	0.25	240±3	20(1.2")	6.0	>150	±3.84@F6	0.05	0.1	190.7	C
CLW2-3D-0.25X-240D-H1.2(IA)	Yes	Yes	80	0.25	240±3	20(1.2")	6.0	>150	±3.84@F6	0.05	0.1	190.7	C
CLW2-3D-1.0X-128-175	No	No	28.2	1.0	128±2	28.2(1.75")	11	>76	±0.45@F8	0.01	0.09	315.5	M58
CLW2-3D-1.0X-128D-175	No	Yes	28.2	1.0	128±2	28.2(1.75")	11	>76	±0.45@F8	0.01	0.09	317.9	M58
CLW2-3D-0.55X-220-175(IA)	Yes	No	51.2	0.55	220	28.2(1.75")	8-32	106-30	2.1-8.4	0.05	0.09	192.7	M58
CLW2-3D-0.55X-220D-175(IA)	Yes	Yes	51.2	0.55	220	28.2(1.75")	8-32	106-30	2.1-8.4	0.05	0.09	197.9	M58
CLW2-3D-0.46X-250-175(IA)	Yes	No	61.4	0.46	250	28.2(1.75")	8-32	110-30	3-12.1	0.03	0.21	184.9	M42
CLW2-3D-0.46X-250D-175(IA)	Yes	Yes	61.4	0.46	250	28.2(1.75")	8-32	110-30	3-12.1	0.03	0.21	190.1	M42
CLW2-3D-0.64X-220-185(IA)	Yes	No	46.8	0.64	220	30(1.85")	8-32	121-31	1.6-6.3	0.01	0.02	205.9	M58
CLW2-3D-0.64X-220D-185(IA)	Yes	Yes	46.8	0.64	220	30(1.85")	8-32	121-31	1.6-6.3	0.01	0.02	213.4	M58
CLW2-3D-0.454X-250-185(IA)	Yes	No	66	0.454	250	30(1.85")	8-32	110-30	3.1-12.4	0.03	0.08	188.1	M58
CLW2-3D-0.454X-250D-185(IA)	Yes	Yes	66	0.454	250	30(1.85")	8-32	110-30	3.1-12.4	0.03	0.08	188.1	M58
CLW2-3D-0.37X-250-185(IA)-A	Yes	No	81	0.37	250	30(1.85")	8-32	114-30	7.7-18.7	0.02	0.1	200.0	M58
CLW2-3D-0.37X-250D-185(IA)-A	Yes	Yes	81	0.37	250	30(1.85")	8-32	114-30	7.7-18.7	0.02	0.1	200.0	M58
CLW2-3D-0.31X-250-185(IA)	Yes	No	96	0.31	250	30(1.85")	8-32	111-30	6.7-26.6	0.035	0.1	193	M58
CLW2-3D-0.31X-250D-185(IA)	Yes	Yes	96	0.31	250	30(1.85")	8-32	111-30	6.7-26.6	0.035	0.1	193	M58
CLW2-3D-1.846X-71-175	No	No	15.7	1.846	71±1	29(1.75")	20.0	>45	±2.5@F20	<0.1	<0.1	311.9	M42
CLW2-3D-0.37X-250-185(IA)-B	Yes	No	81	0.37	250	30(1.85")	8-32	114-30	4.7-18.7	0.02	0.1	200	M58
CLW2-3D-0.37X-250D-185(IA)-B	Yes	Yes	81	0.37	250	30(1.85")	8-32	114-30	4.7-18.7	0.02	0.1	200	M58
CLW2-3D-2.8X-90-H2	No	No	11.8	2.8	90±1	33(2")	11	>90	±0.05@F11	<0.02	<0.05	300.9	M58
CLW2-3D-2.8X-90D-H2	No	Yes	11.8	2.8	90±1	33(2")	11	>90	±0.05@F11	<0.02	<0.05	300.9	M58
CLW2-3D-0.7X-92-H2	No	No	44.8	0.7	92±1	33(2")	7.8	>90	±0.05@F7.8	0.1	-	194.2	M58
CLW2-3D-0.1536X-220-H2	No	No	215	0.1536	220±3	33(2")	10.0	>90	±13.6@F8	<0.1	<0.1	369	M42
CLW2-3D-1.0X-102-FF(IA)	Yes	No	44	1.0	102	44(35mm Full)	6.1-32	150-33	0.49-2.56	0.04	0.04	297.3	M58
CLW2-3D-1.0X-102D-FF(IA)	Yes	Yes	44	1.0	102	44(35mm Full)	6.1-32	150-33	0.49-2.56	0.04	0.04	297.3	M58
CLW2-3D-1.5X-92-FF(IA)	Yes	No	29.3	1.5	92.5	44(35mm Full)	7.6-32	120-32	0.29-1.1	0.025	0.03	320	M58
CLW2-3D-1.5X-92D-FF(IA)	Yes	Yes	29.3	1.5	92.5	44(35mm Full)	7.6-32	120-32	0.29-1.1	0.025	0.03	320	M58
CLW2-3D-2.0X-100-FF(IA)	Yes	No	22	2.0	100	44(35mm Full)	8-32	118-32	0.16-0.64	0.045	0.0085	282.5	M58
CLW2-3D-2.0X-100D-FF(IA)	Yes	Yes	22	2.0	100	44(35mm Full)	8-32	118-32	0.16-0.64	0.045	0.0085	282.5	M58
CLW2-3D-3.0X-60-FF(IA)	Yes	No	14.6	3.0	60	44(35mm Full)	8.8-32	106-33	0.08-0.28	0.045	0.0065	359.4	M58
CLW2-3D-3.0X-60D-FF(IA)	Yes	Yes	14.6	3.0	60	44(35mm Full)	8.8-32	106-33	0.08-0.28	0.045	0.0065	359.4	M58
CLW2-3D-4.0X-60-FF(IA)	Yes	No	11	4.0	60±1	44(35mm Full)	11-32	90-32	0.06-0.16	0.02	0.02	365.4	M58
CLW2-3D-4.0X-60D-FF(IA)	Yes	Yes	11	4.0	60±1	44(35mm Full)	11-32	90-32	0.06-0.16	0.02	0.02	365.4	M58
CLW2-3D-5.0X-60-FF(IA)	Yes	No	8.8	5.0	60	44(35mm Full)	13-32	74-31	0.04-0.1	0.02	0.01	387	M58
CLW2-3D-5.0X-60D-FF(IA)	Yes	Yes	8.8	5.0	60	44(35mm Full)	13-32	74-31	0.04-0.1	0.02	0.01	387	M58
CLW2-3D-0.462X-378-Q434	No	No	94	0.462	378±4	43.4	8.0	>115	±1.5@F8.0	<0.1	<0.1	456.9	M58
CLW2-3D-0.462X-378D-Q434	No	Yes	94	0.462	378±4	43.4	8.0	>115	±1.5@F8.0	<0.1	<0.1	456.9	M58
CLW2-3D-0.53X-338-Q434	No	No	82	0.53	338±5	43.4	10.0	>92	±1.4@F10	<0.1	<0.1	464.4	M58
CLW2-3D-0.53X-338D-Q434	No	Yes	82	0.53	338±5	43.4	10.0	>92	±1.4@F10	<0.1	<0.1	464.4	M58

**Warm tips:** The above DOF is just theoretical value at the ideal aperture (eg. ±763@F11). Actual DOF or the DOF what you need, please check with our sales engineer before order cfm.

# LENS PARAMETER DIAGRAM

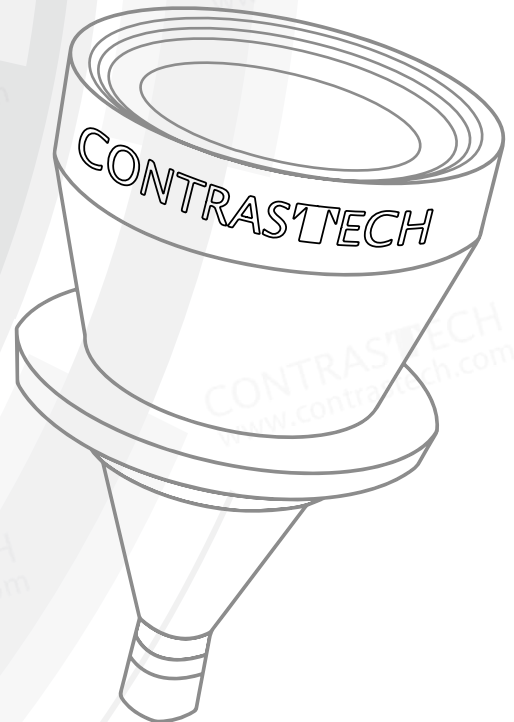

# CLW2-3D Series

## CLW2-3D-0.25X-240-H1.2(IA)

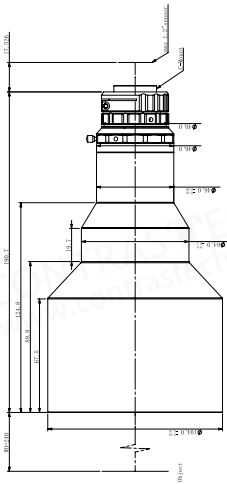

FOV(Φmm)	80
Mag.(x)	0.25
WD(mm)	240±3
Max Sensor Size(Φmm)	20(1.2")
F/#	6.0
MTF30(lp/mm)	>150
DoF(mm)	±3.84@F6
Distortion(% max)	0.05
Telecentricity(° max)	0.1
NA	0.02091
Length(mm)	190.7
Mount	C
Variable Iris	Yes
Coaxial Light	No
Field of View(mm xmm)	
1.2" IMX530/540(14.6x12.6)	58.4x50.4

## CLW2-3D-0.25X-240D-H1.2(IA)

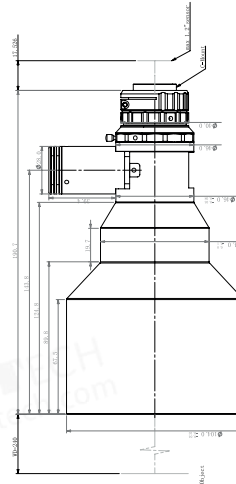

FOV(Φmm)	80
Mag.(x)	0.25
WD(mm)	240±3
Max Sensor Size(Φmm)	20(1.2")
F/#	6.0
MTF30(lp/mm)	>150
DoF(mm)	±3.84@F6
Distortion(% max)	0.05
Telecentricity(° max)	0.1
NA	0.02091
Length(mm)	190.7
Mount	C
Variable Iris	Yes
Coaxial Light	Yes
Field of View(mm xmm)	
1.2" IMX530/540(14.6x12.6)	58.4x50.4

## CLW2-3D-1.0X-128-175

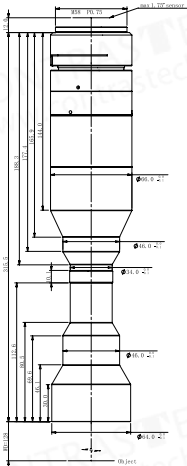

FOV(Φmm)	28.2
Mag.(x)	1.0
WD(mm)	128±2
Max Sensor Size(Φmm)	28.2(1.75")
F/#	11
MTF30(lp/mm)	>76
DoF(mm)	±0.45@F8
Distortion(% max)	0.01
Telecentricity(° max)	0.09
NA	0.04538
Length(mm)	315.5
Mount	M58
Variable Iris	No
Coaxial Light	No
Field of View(mm xmm)	
1.75" IMX342(22.3x16.7)	22.3x16.7

## CLW2-3D-1.0X-128D-175

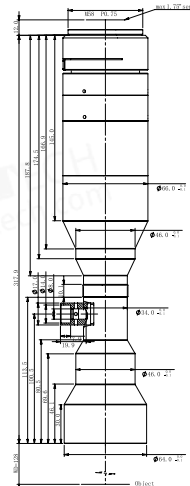

FOV(Φmm)	28.2
Mag.(x)	1.0
WD(mm)	128±2
Max Sensor Size(Φmm)	28.2(1.75")
F/#	11
MTF30(lp/mm)	>76
DoF(mm)	±0.45@F8
Distortion(% max)	0.01
Telecentricity(° max)	0.09
NA	0.04538
Length(mm)	317.9
Mount	M58
Variable Iris	No
Coaxial Light	Yes
Field of View(mm xmm)	
1.75" IMX342(22.3x16.7)	22.3x16.7

## CLW2-3D-0.55X-220-175(IA)

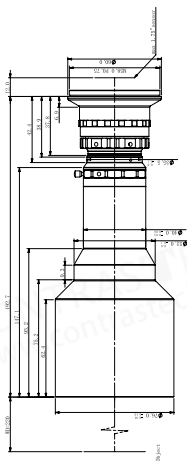

FOV(Φmm)	51.2
Mag.(x)	0.55
WD(mm)	220
Max Sensor Size(Φmm)	28.2(1.75")
F/#	8-32
MTF30(lp/mm)	106-30
DoF(mm)	2.1-8.4
Distortion(% max)	0.05
Telecentricity(° max)	0.09
NA	0.0344-0.0086
Length(mm)	192.7
Mount	M58
Variable Iris	Yes
Coaxial Light	No
Field of View(mm xmm)	
1.75" IMX342(22.3x16.7)	40.5x30.4

## CLW2-3D-0.55X-220D-175(IA)

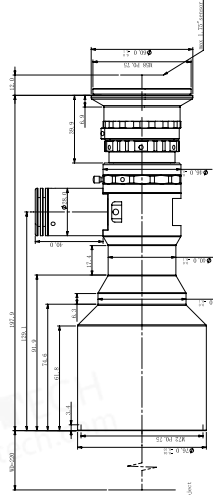

FOV(Φmm)	51.2
Mag.(x)	0.55
WD(mm)	220
Max Sensor Size(Φmm)	28.2(1.75")
F/#	8-32
MTF30(lp/mm)	106-30
DoF(mm)	2.1-8.4
Distortion(% max)	0.05
Telecentricity(° max)	0.09
NA	0.0344-0.0086
Length(mm)	197.9
Mount	M58
Variable Iris	Yes
Coaxial Light	Yes
Field of View(mm xmm)	
1.75" IMX342(22.3x16.7)	40.5x30.4

# CLW2-3D Series

## CLW2-3D-0.46X-250-175(IA)

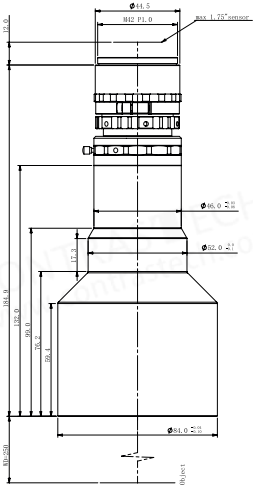

FOV(Φmm)	61.4
Mag.(x)	0.46
WD(mm)	250
Max Sensor Size(Φmm)	28.2(1.75")
F/#	8-32
MTF30(lp/mm)	110-30
DoF(mm)	3-12.1
Distortion(% max)	0.03
Telecentricity(° max)	0.21
NA	0.0288-0.0072
Length(mm)	184.9
Mount	M42
Variable Iris	Yes
Coaxial Light	No
Field of View(mm xmm)	
1.75" IMX342(22.3x16.7)	48.5x36.3

## CLW2-3D-0.46X-250D-175(IA)

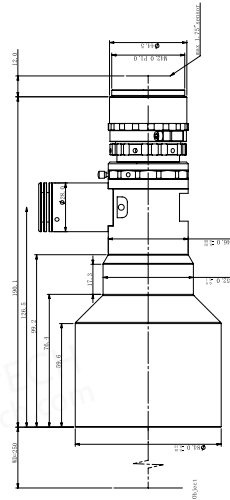

FOV(Φmm)	61.4
Mag.(x)	0.46
WD(mm)	250
Max Sensor Size(Φmm)	28.2(1.75")
F/#	8-32
MTF30(lp/mm)	110-30
DoF(mm)	3-12.1
Distortion(% max)	0.03
Telecentricity(° max)	0.21
NA	0.0288-0.0072
Length(mm)	190.1
Mount	M42
Variable Iris	Yes
Coaxial Light	Yes
Field of View(mm xmm)	
1.75" IMX342(22.3x16.7)	48.5x36.3

## CLW2-3D-0.64X-220-185(IA)

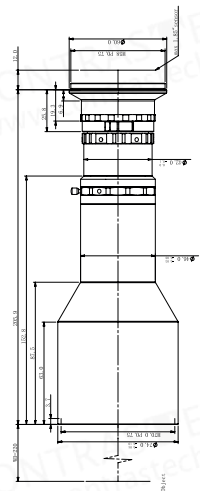

FOV(Φmm)	46.8
Mag.(x)	0.64
WD(mm)	220
Max Sensor Size(Φmm)	30(1.85")
F/#	8-32
MTF30(lp/mm)	121-31
DoF(mm)	1.6-6.3
Distortion(% max)	0.01
Telecentricity(° max)	0.02
NA	0.04-0.01
Length(mm)	205.9
Mount	M58
Variable Iris	Yes
Coaxial Light	No
Field of View(mm xmm)	
1.85" GSPRINT4521(23.0x18.4)	35.9x28.8

## CLW2-3D-0.64X-220D-185(IA)

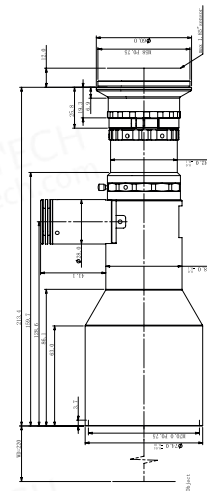

FOV(Φmm)	46.8
Mag.(x)	0.64
WD(mm)	220
Max Sensor Size(Φmm)	30(1.85")
F/#	8-32
MTF30(lp/mm)	121-31
DoF(mm)	1.6-6.3
Distortion(% max)	0.01
Telecentricity(° max)	0.02
NA	0.04-0.01
Length(mm)	213.4
Mount	M58
Variable Iris	Yes
Coaxial Light	Yes
Field of View(mm xmm)	
1.85" GSPRINT4521(23.0x18.4)	35.9x28.8

## CLW2-3D-0.454X-250-185(IA)

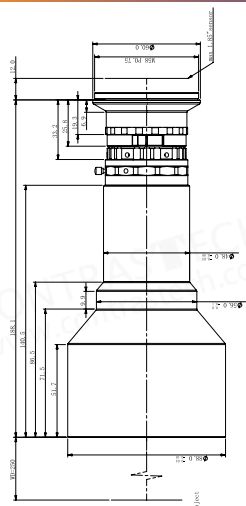

FOV(Φmm)	66
Mag.(x)	0.454
WD(mm)	250
Max Sensor Size(Φmm)	30(1.85")
F/#	8-32
MTF30(lp/mm)	110-30
DoF(mm)	3.1-12.4
Distortion(% max)	0.03
Telecentricity(° max)	0.08
NA	0.02838-0.00709
Length(mm)	188.1
Mount	M58
Variable Iris	Yes
Coaxial Light	No
Field of View(mm xmm)	
1.85" GSPRINT4521(23.0x18.4)	50.7x40.5

## CLW2-3D-0.454X-250D-185(IA)

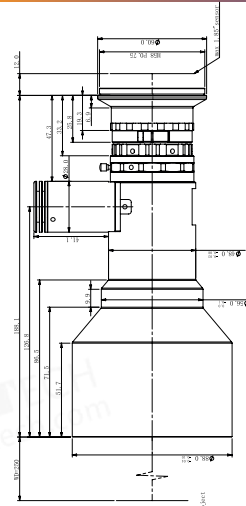

FOV(Φmm)	66
Mag.(x)	0.454
WD(mm)	250
Max Sensor Size(Φmm)	30(1.85")
F/#	8-32
MTF30(lp/mm)	110-30
DoF(mm)	3.1-12.4
Distortion(% max)	0.03
Telecentricity(° max)	0.08
NA	0.02838-0.00709
Length(mm)	188.1
Mount	M58
Variable Iris	Yes
Coaxial Light	Yes
Field of View(mm xmm)	
1.85" GSPRINT4521(23.0x18.4)	50.7x40.5

# CLW2-3D Series

## CLW2-3D-0.37X-250-185(IA)-A

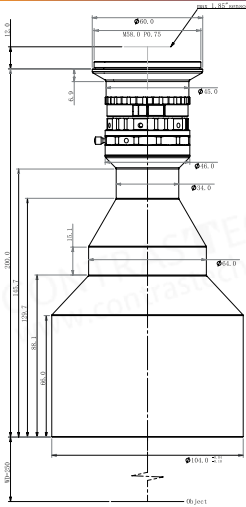

FOV(Φmm)	81
Mag.(x)	0.37
WD(mm)	250
Max Sensor Size(Φmm)	30(1.85")
F/#	8-32
MTF30(lp/mm)	114-30
DoF(mm)	7.7-18.7
Distortion(% max)	0.02
Telecentricity(° max)	0.1
NA	0.02312-0.00578
Length(mm)	200.0
Mount	M58
Variable Iris	Yes
Coaxial Light	No
Field of View(mm xmm)	1.85" GSPRINT4521(23.0x18.4) 62.2x49.7

## CLW2-3D-0.37X-250D-185(IA)-A

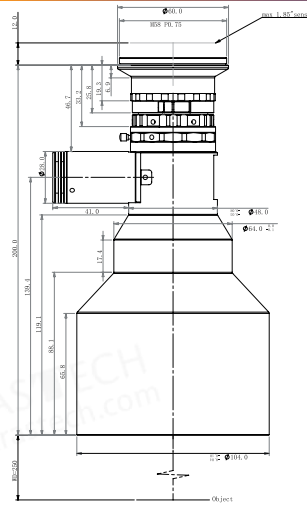

FOV(Φmm)	81
Mag.(x)	0.37
WD(mm)	250
Max Sensor Size(Φmm)	30(1.85")
F/#	8-32
MTF30(lp/mm)	114-30
DoF(mm)	7.7-18.7
Distortion(% max)	0.02
Telecentricity(° max)	0.1
NA	0.02312-0.00578
Length(mm)	200.0
Mount	M58
Variable Iris	Yes
Coaxial Light	Yes
Field of View(mm xmm)	1.85" GSPRINT4521(23.0x18.4) 62.2x49.7

## CLW2-3D-0.31X-250-185(IA)

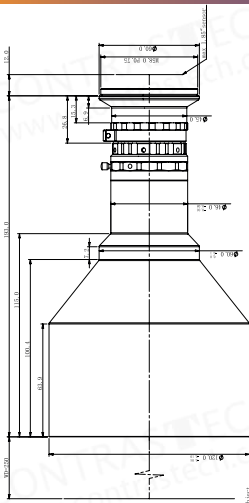

FOV(Φmm)	96
Mag.(x)	0.31
WD(mm)	250
Max Sensor Size(Φmm)	30(1.85")
F/#	8-32
MTF30(lp/mm)	111-30
DoF(mm)	6.7-26.6
Distortion(% max)	0.035
Telecentricity(° max)	0.1
NA	0.02312-0.00578
Length(mm)	193
Mount	M58
Variable Iris	Yes
Coaxial Light	No
Field of View(mm xmm)	1.85" GSPRINT4521(23.0x18.4) 74.2x59.4

## CLW2-3D-0.31X-250D-185(IA)

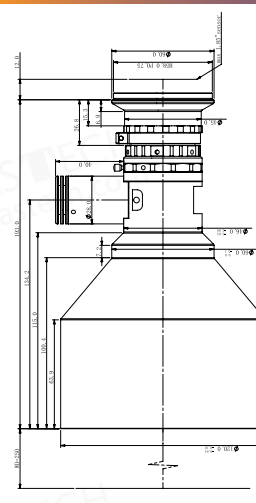

FOV(Φmm)	96
Mag.(x)	0.31
WD(mm)	250
Max Sensor Size(Φmm)	30(1.85")
F/#	8-32
MTF30(lp/mm)	111-30
DoF(mm)	6.7-26.6
Distortion(% max)	0.035
Telecentricity(° max)	0.1
NA	0.02312-0.00578
Length(mm)	193
Mount	M58
Variable Iris	Yes
Coaxial Light	Yes
Field of View(mm xmm)	1.85" GSPRINT4521(23.0x18.4) 74.2x59.4

## CLW2-3D-1.846X-71-175

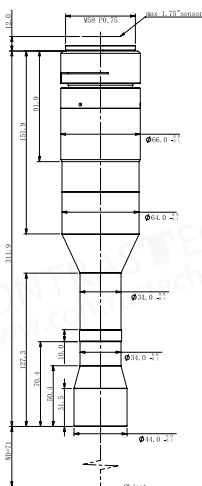

FOV(Φmm)	15.7
Mag.(x)	1.846
WD(mm)	71±1
Max Sensor Size(Φmm)	29(1.75")
F/#	20.0
MTF30(lp/mm)	>45
DoF(mm)	±2.5@F20
Distortion(% max)	<0.1
Telecentricity(° max)	<0.1
NA	0.0461
Length(mm)	311.9
Mount	M42
Variable Iris	No
Coaxial Light	No
Field of View(mm xmm)	1.75" IMX342(22.3x16.7) 12.1x9

## CLW2-3D-0.37X-250-185(IA)-B

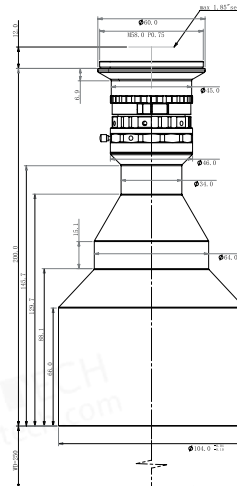

FOV(Φmm)	81
Mag.(x)	0.37
WD(mm)	250
Max Sensor Size(Φmm)	30(1.85")
F/#	8-32
MTF30(lp/mm)	114-30
DoF(mm)	4.7-18.7
Distortion(% max)	0.02
Telecentricity(° max)	0.1
NA	0.02312-0.00578
Length(mm)	200
Mount	M58
Variable Iris	Yes
Coaxial Light	No
Field of View(mm xmm)	1.85" GSPRINT4521(23.0x18.4) 62.2x49.7

# CLW2-3D Series

## CLW2-3D-0.37X-250D-185(IA)-B

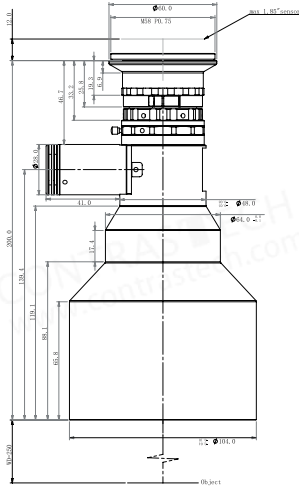

FOV(Φmm)	81
Mag.(x)	0.37
WD(mm)	250
Max Sensor Size(Φmm)	30(1.85")
F/#	8-32
MTF30(lp/mm)	114-30
DoF(mm)	4.7-18.7
Distortion(% max)	0.02
Telecentricity(° max)	0.1
NA	0.02312-0.00578
Length(mm)	200
Mount	M58
Variable Iris	Yes
Coaxial Light	Yes
Field of View(mmxmm)	1.85" GSPRINT4521(23.0x18.4) 62.2x49.7

## CLW2-3D-2.8X-90-H2

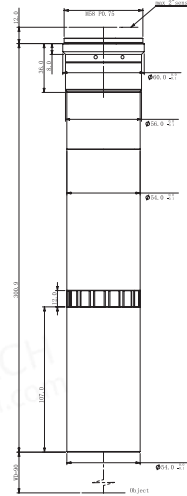

FOV(Φmm)	11.8
Mag.(x)	2.8
WD(mm)	90±1
Max Sensor Size(Φmm)	33(2")
F/#	11
MTF30(lp/mm)	>90
DoF(mm)	±0.05@F11
Distortion(% max)	<0.02
Telecentricity(° max)	<0.05
NA	0.1421921
Length(mm)	300.9
Mount	M58
Variable Iris	No
Coaxial Light	No
Field of View(mmxmm)	2" PYTHON 25K (23.04x23.04) 8.2x8.2

## CLW2-3D-2.8X-90D-H2

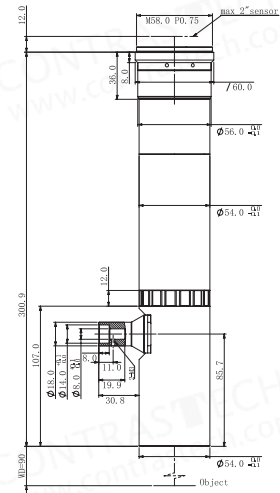

FOV(Φmm)	11.8
Mag.(x)	2.8
WD(mm)	90±1
Max Sensor Size(Φmm)	33(2")
F/#	11
MTF30(lp/mm)	>90
DoF(mm)	±0.05@F11
Distortion(% max)	<0.02
Telecentricity(° max)	<0.05
NA	0.1421921
Length(mm)	300.9
Mount	M58
Variable Iris	No
Coaxial Light	Yes
Field of View(mmxmm)	2" PYTHON 25K (23.04x23.04) 8.2x8.2

## CLW2-3D-0.7X-92-H2

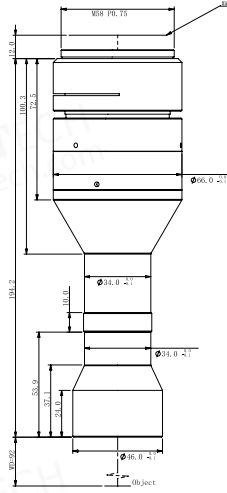

FOV(Φmm)	44.8
Mag.(x)	0.7
WD(mm)	92±1
Max Sensor Size(Φmm)	33(2")
F/#	7.8
MTF30(lp/mm)	>90
DoF(mm)	±0.05@F7.8
Distortion(% max)	0.1
Telecentricity(° max)	-
NA	0.04688
Length(mm)	194.2
Mount	M58
Variable Iris	No
Coaxial Light	No
Field of View(mmxmm)	2" PYTHON 25K (23.04x23.04) 31.3x31.3

## CLW2-3D-0.1536X-220-H2

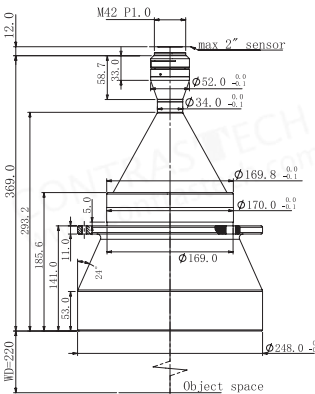

FOV(Φmm)	215
Mag.(x)	0.1536
WD(mm)	220±3
Max Sensor Size(Φmm)	33(2")
F/#	10.0
MTF30(lp/mm)	>90
DoF(mm)	±13.6@F8
Distortion(% max)	<0.1
Telecentricity(° max)	<0.1
NA	0.0096
Length(mm)	369
Mount	M42
Variable Iris	No
Coaxial Light	No
Field of View(mmxmm)	2" DALSA 12M(24.58x18.43) 160x120 2" PYTHON 25K (23.04x23.04) 150x150

## CLW2-3D-1.0X-102-FF(IA)

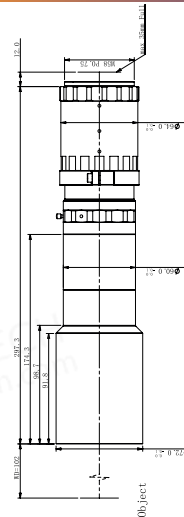

FOV(Φmm)	44
Mag.(x)	1.0
WD(mm)	102
Max Sensor Size(Φmm)	44(35mm Full)
F/#	6.1-32
MTF30(lp/mm)	150-33
DoF(mm)	0.49-2.56
Distortion(% max)	0.04
Telecentricity(° max)	0.04
NA	0.083-0.01568
Length(mm)	297.3
Mount	M58
Variable Iris	Yes
Coaxial Light	No
Field of View(mmxmm)	CMV50000 (36.43x27.62) 29.9x22.4

# CLW2-3D Series

## CLW2-3D-1.0X-102D-FF(IA)

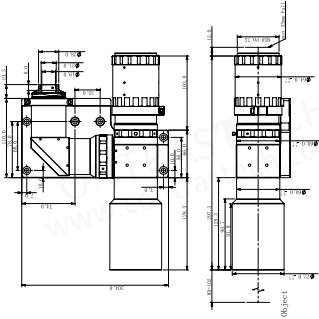

FOV(Φmm)	44
Mag.(x)	1.0
WD(mm)	102
Max Sensor Size(Φmm)	44(35mm Full)
F/#	6.1-32
MTF30(lp/mm)	150-33
DoF(mm)	0.49-2.56
Distortion(% max)	0.04
Telecentricity(° max)	0.04
NA	0.083-0.01568
Length(mm)	297.3
Mount	M58
Variable Iris	Yes
Coaxial Light	Yes
Field of View(mmxmm)	37.4mm GMAX3265(29.9x22.4) 29.9x22.4

## CLW2-3D-1.5X-92-FF(IA)

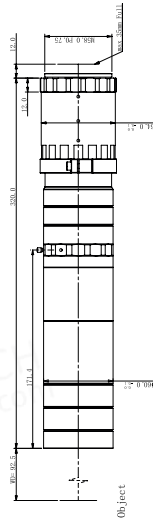

FOV(Φmm)	29.3
Mag.(x)	1.5
WD(mm)	92.5
Max Sensor Size(Φmm)	44(35mm Full)
F/#	7.6-32
MTF30(lp/mm)	120-32
DoF(mm)	0.29-1.1
Distortion(% max)	0.025
Telecentricity(° max)	0.03
NA	0.1-0.02346
Length(mm)	320
Mount	M58
Variable Iris	Yes
Coaxial Light	No
Field of View(mmxmm)	37.4mm GMAX3265(29.9x22.4) 19.9x14.9

## CLW2-3D-1.5X-92D-FF(IA)

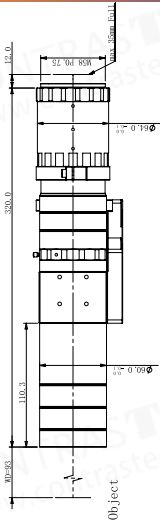

FOV(Φmm)	29.3
Mag.(x)	1.5
WD(mm)	92.5
Max Sensor Size(Φmm)	44(35mm Full)
F/#	7.6-32
MTF30(lp/mm)	120-32
DoF(mm)	0.29-1.1
Distortion(% max)	0.025
Telecentricity(° max)	0.03
NA	0.1-0.02346
Length(mm)	320
Mount	M58
Variable Iris	Yes
Coaxial Light	Yes
Field of View(mmxmm)	37.4mm GMAX3265(29.9x22.4) 19.9x14.9

## CLW2-3D-2.0X-100-FF(IA)

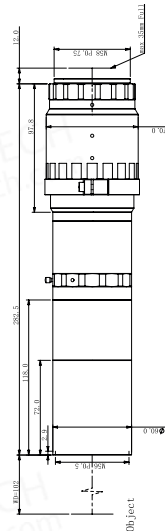

FOV(Φmm)	22
Mag.(x)	2.0
WD(mm)	100
Max Sensor Size(Φmm)	44(35mm Full)
F/#	8-32
MTF30(lp/mm)	118-32
DoF(mm)	0.16-0.64
Distortion(% max)	0.045
Telecentricity(° max)	0.0085
NA	0.125-0.03125
Length(mm)	282.5
Mount	M58
Variable Iris	Yes
Coaxial Light	No
Field of View(mmxmm)	37.4mm GMAX3265(29.9x22.4) 15.0x11.2

## CLW2-3D-2.0X-100D-FF(IA)

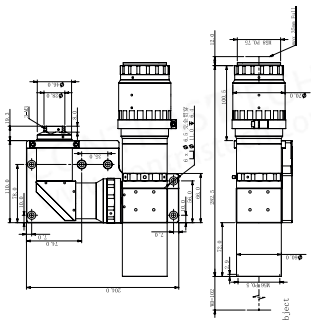

FOV(Φmm)	22
Mag.(x)	2.0
WD(mm)	100
Max Sensor Size(Φmm)	44(35mm Full)
F/#	8-32
MTF30(lp/mm)	118-32
DoF(mm)	0.16-0.64
Distortion(% max)	0.045
Telecentricity(° max)	0.0085
NA	0.125-0.03125
Length(mm)	282.5
Mount	M58
Variable Iris	Yes
Coaxial Light	Yes
Field of View(mmxmm)	37.4mm GMAX3265(29.9x22.4) 15.0x11.2

## CLW2-3D-3.0X-60-FF(IA)

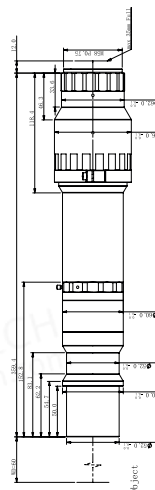

FOV(Φmm)	14.6
Mag.(x)	3.0
WD(mm)	60
Max Sensor Size(Φmm)	44(35mm Full)
F/#	8.8-32
MTF30(lp/mm)	106-33
DoF(mm)	0.08-0.28
Distortion(% max)	0.045
Telecentricity(° max)	0.0065
NA	0.17-0.04693
Length(mm)	359.4
Mount	M58
Variable Iris	Yes
Coaxial Light	No
Field of View(mmxmm)	CMV50000 (36.43x27.62) 12.1x9.2

# CLW2-3D Series

## CLW2-3D-3.0X-60D-FF(IA)

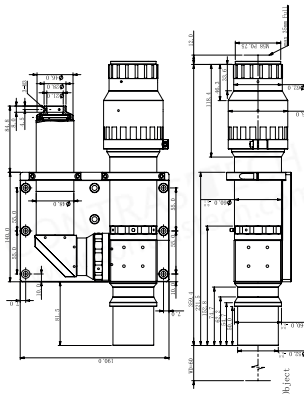

FOV(Φmm)	14.6
Mag.(x)	3.0
WD(mm)	60
Max Sensor Size(Φmm)	44(35mm Full)
F/#	8.8-32
MTF30(lp/mm)	106-33
DoF(mm)	0.08-0.28
Distortion(% max)	0.045
Telecentricity(° max)	0.0065
NA	0.17-0.04693
Length(mm)	359.4
Mount	M58
Variable Iris	Yes
Coaxial Light	Yes
Field of View(mmxmm)	
CMV50000 (36.43x27.62)	12.1x9.2

## CLW2-3D-4.0X-60-FF(IA)

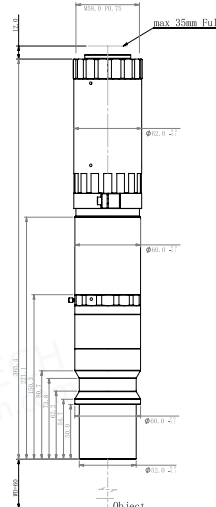

FOV(Φmm)	11
Mag.(x)	4.0
WD(mm)	60±1
Max Sensor Size(Φmm)	44(35mm Full)
F/#	11-32
MTF30(lp/mm)	90-32
DoF(mm)	0.06-0.16
Distortion(% max)	0.02
Telecentricity(° max)	0.02
NA	0.18- 0.0624
Length(mm)	365.4
Mount	M58
Variable Iris	Yes
Coaxial Light	No
Field of View(mmxmm)	
37.4mm GMAX3265(29.9x22.4)	7.5x5.6

## CLW2-3D-4.0X-60D-FF(IA)

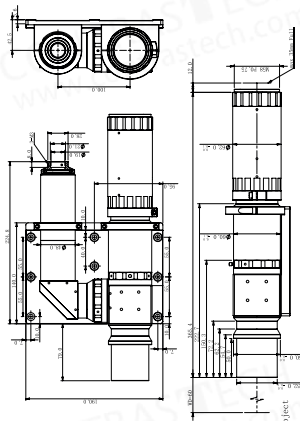

FOV(Φmm)	11
Mag.(x)	4.0
WD(mm)	60±1
Max Sensor Size(Φmm)	44(35mm Full)
F/#	11-32
MTF30(lp/mm)	90-32
DoF(mm)	0.06-0.16
Distortion(% max)	0.02
Telecentricity(° max)	0.02
NA	0.18- 0.0624
Length(mm)	365.4
Mount	M58
Variable Iris	Yes
Coaxial Light	Yes
Field of View(mmxmm)	
37.4mm GMAX3265(29.9x22.4)	7.5x5.6

## CLW2-3D-5.0X-60-FF(IA)

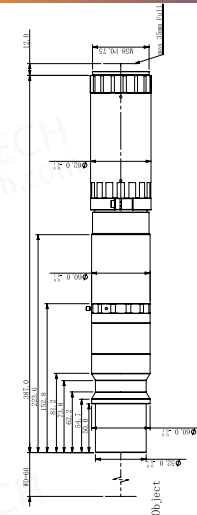

FOV(Φmm)	8.8
Mag.(x)	5.0
WD(mm)	60
Max Sensor Size(Φmm)	44(35mm Full)
F/#	13-32
MTF30(lp/mm)	74-31
DoF(mm)	0.04-0.1
Distortion(% max)	0.02
Telecentricity(° max)	0.01
NA	0.19-0.07792
Length(mm)	387
Mount	M58
Variable Iris	Yes
Coaxial Light	No
Field of View(mmxmm)	
37.4mm GMAX3265(29.9x22.4)	6.0x4.5

## CLW2-3D-5.0X-60D-FF(IA)

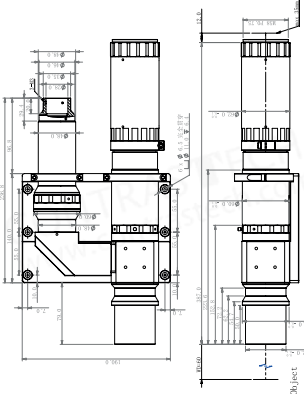

FOV(Φmm)	8.8
Mag.(x)	5.0
WD(mm)	60
Max Sensor Size(Φmm)	44(35mm Full)
F/#	13-32
MTF30(lp/mm)	74-31
DoF(mm)	0.04-0.1
Distortion(% max)	0.02
Telecentricity(° max)	0.01
NA	0.19-0.07792
Length(mm)	387
Mount	M58
Variable Iris	Yes
Coaxial Light	Yes
Field of View(mmxmm)	
37.4mm GMAX3265(29.9x22.4)	6.0x4.5

## CLW2-3D-0.462X-378-Q434

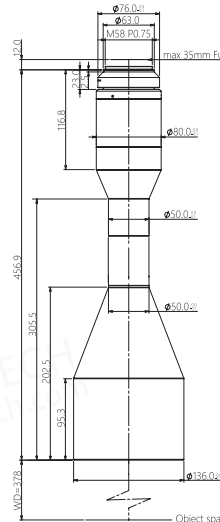

FOV(Φmm)	94
Mag.(x)	0.462
WD(mm)	378±4
Max Sensor Size(Φmm)	43.4
F/#	8.0
MTF30(lp/mm)	>115
DoF(mm)	±1.5@F8.0
Distortion(% max)	<0.1
Telecentricity(° max)	<0.1
NA	0.02889
Length(mm)	456.9
Mount	M58
Variable Iris	No
Coaxial Light	No
Field of View(mmxmm)	
CMV50000(36.43x27.62)	78.9x59.8
KA129050/2(36.17x24.11)	78.3x52.2
KA143142(36.18x24.12)	78.3x52.2

# CLW2-3D Series

## CLW2-3D-0.462X-378D-Q434

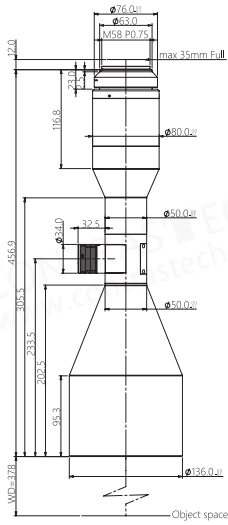

FOV(Φmm)	94
Mag.(x)	0.462
WD(mm)	378±4
Max Sensor Size(Φmm)	43.4
F/#	8.0
MTF30(lp/mm)	>115
DoF(mm)	±1.5@F8.0
Distortion(% max)	<0.1
Telecentricity(° max)	<0.1
NA	0.02889
Length(mm)	456.9
Mount	M58
Variable Iris	No
Coaxial Light	Yes
Field of View(mm xmm)	
CMV50000(36.43x27.62)	78.9x59.8
KAI29050/2(36.17x24.11)	78.3x52.2
KAI43142(36.18x24.12)	78.3x52.2

## CLW2-3D-0.53X-338-Q434

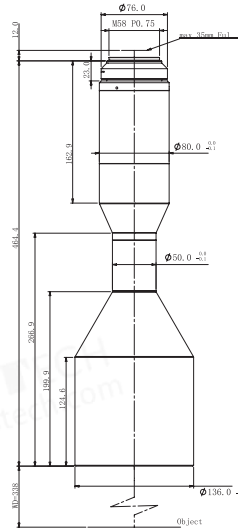

FOV(Φmm)	82
Mag.(x)	0.530
WD(mm)	338±5
Max Sensor Size(Φmm)	43.4
F/#	10.0
MTF30(lp/mm)	>92
DoF(mm)	±1.4@F10
Distortion(% max)	<0.1
Telecentricity(° max)	<0.1
NA	0.02649
Length(mm)	464.4
Mount	M58
Variable Iris	No
Coaxial Light	No
Field of View(mm xmm)	
CMV50000(36.43x27.62)	68.7x52.1
KAI29050/2(36.17x24.11)	68.2x45.5
KAI43142(36.18x24.12)	68.3x45.5

## CLW2-3D-0.53X-338D-Q434

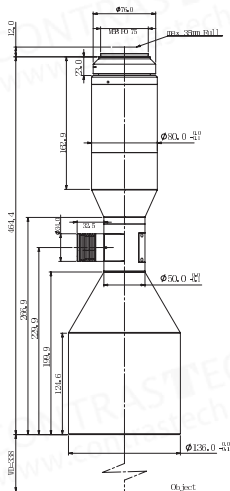

FOV(Φmm)	82
Mag.(x)	0.53
WD(mm)	338±5
Max Sensor Size(Φmm)	43.4
F/#	10.0
MTF30(lp/mm)	>92
DoF(mm)	±1.4@F10
Distortion(% max)	<0.1
Telecentricity(° max)	<0.1
NA	0.02649
Length(mm)	464.4
Mount	M58
Variable Iris	No
Coaxial Light	Yes
Field of View(mm xmm)	
CMV50000(36.43x27.62)	68.7x52.1
KAI29050/2(36.17x24.11)	68.2x45.5
KAI43142(36.18x24.12)	68.3x45.5

# CONTRASTTECH

Machine Vision Expert



**1 Million**  
FPS Camera

Imaging Solutions  
OEM/ODM



**Infrared Camera**

**0.3-14μm**

NIR/SWIR/MWIR/LWIR



**Kepler Pro**

**Software**

No Need  
Programming



CONTRASTTECH

Hangzhou Contrastech Technology Co., Ltd.  
No. 8 Xiyuan 9th Road, West Lake District  
Hangzhou Zhejiang 310030 China  
Tel: 86-571-86888309  
[www.contrasttech.com](http://www.contrasttech.com)

