

1/1.8" ~ 4/3" C-MOUNT

HOT

C-MOUNT



C-MOUNT FIXED FA LENSES

These days, C Mount lenses are still the most common type in industrial image processing, esp. in factory automation. Mostly they are used with digital cameras like USB, Fire_Wire, Gig-E and Smart Cameras.

LEM series is an advanced industrial lens product researched and developed by ContrastTech Co., Ltd, which catering to the demands of recent market environment.

The quality of our lens is guaranteed by refined optical glasses, mature coating process and advanced optical structure.

Developed with high cost-performance ratio, the quality and performance are quite competitive with foreign counterparts.

PRODUCT FEATURES

1. Suitable for 5 mega up to 10 mega pixels sensors.
2. High resolution at whole range of WD and excellent brightness.
3. Robust design, suitable for most machine vision applications.
4. Professional MTF optimization
5. Lockable focus and iris screws prevent movement during vibrations or shocks.
6. High cost-performance ratio

Subject to change without prior notice.

For latest specifications and availability, please contact our sales representatives or visit our website: www.contrasttech.com

1/1.8" C-MOUNT FIXED LENSES

Part name	Focal Length (mm)	Aperture (F/#)	M.O.D. (m)	Angle of View (deg.)	TV Distortion (%)	Filter Size	Format (")	Type
LEM0420	4.0	F2.0	0.1	D:94.0° H:82.9° V:66.5°	<0.5%	-	1/1.8"	Standard
LEM0620	6.0	F2.0	0.1	D:64.5° H:54.1° V:41.9°	<0.1%	M25.5× 0.5	1/1.8"	Standard
LEM0820	8.0	F2.0	0.1	D:56.0° H:46.8° V:36.0°	<0.1%	M25.5× 0.5	1/1.8"	Standard
LEM1220	12.0	F2.0	0.1	D:40.7° H:33.0° V:24.3°	<0.3%	M25.5× 0.5	1/1.8"	Standard
LEM1620	16.0	F2.0	0.1	D:30.3° H:24.7° V:18.2°	<0.1%	M25.5× 0.5	1/1.8"	Standard
LEM2520	25.0	F2.0	0.1	D:19.0° H:13.6° V:11.3°	<0.1%	M25.5× 0.5	1/1.8"	Standard
LEM3520	35.0	F2.0	0.2	D:12.24° H:8.8° V:7.0°	<0.1%	M25.5× 0.5	1/1.8"	Standard
LEM5028	50.0	F2.8	0.3	D:10.2° H:8.2° V:6.1°	<0.05%	-	1/1.8"	Standard
LEM7528	75.0	F2.8	0.5	D:5.84° H:5.4° V:4.04°	<0.05%	-	1/1.8"	Standard
LEM0616MP5	6.0	F1.6	0.1	D:71.7° H:60.1° V:46.6°	<0.54%	M34× 0.5	1/1.8"	Standard
LEM01414FE	1.4	F1.4	0.08	D:185° H:185° V:185°	<0.25%	-	1/2"	Fisheye

2/3" C-MOUNT FIXED LENSES

Part name	Focal Length (mm)	Aperture (F/#)	M.O.D. (m)	Angle of View (deg.)	TV Distortion (%)	Filter Size	Mega pixels	Type
LEM0518MP10	5.0	F1.8	0.1	D:95.45° H:66.85° V:82.7°	<5%	M62× 0.75	10	Standard
LEM0814CBMP8	8.0	F1.4	0.1	D:61.7° H:56.3° V:43.7°	<0.1%	M37× 0.5	8	Standard
LEM1216CBMP8	12.0	F1.6	0.15	D:46.6° H:39° V:30.3°	<0.8%	M30.5× 0.5	8	Standard
LEM1614CBMP8	16.0	F1.4	0.3	D:37.3° H:30.3° V:23°	<0.1%	M30.5× 0.5	8	Standard
LEM2514CBMP8	25.0	F1.4	0.3	D:24.6° H:20° V:15°	<0.2%	M30.5× 0.5	8	Standard
LEM3514CBMP8	35.0	F1.4	0.2	D:17.3° H:13.9° V:10.4°	<0.8%	M37× 0.5	8	Standard
LEM5014CBMP8	50.0	F1.4	0.3	D:13.04° H:10.46° V:7.86°	<0.8%	M37× 0.5	8	Standard

1"~1.1" C-MOUNT FIXED LENSES

Part name	Focal Length (mm)	Aperture (F/#)	Range of WD (m)	Angle of View (deg.)	Filter Size	TV Distortion (%)	Mega pixels	Type
LEM7528MP5	75	F2.8	0.6m ~ ∞	11.4°× 9.2°× 4.8°	M34× 0.5	<0.07%	5	Standard
LEM1214CB-H1	12.5	F1.4	0.1m ~ ∞	66.3°× 54.5°× 42°	M46× 0.75	<1.8%	5	Standard
LEM5014CB-H1	50	F1.4	0.3m ~ ∞	17.14°× 13.86°× 10.4°	M46× 0.75	<0.1%	5	Standard
LEM7518CB-H1	75	F1.8	0.7m ~ ∞	12.2°× 9.8°× 7.4°	M55× 0.75	<0.05%	5	Standard
LEM0814CE-H1	8	F1.4	0.2m ~ ∞	88°× 70.5°× 53°	-	<1.5%	5	Standard
LEM1216CE-H1	12	F1.6	1.0m ~ ∞	68.8°× 57.1°× 44.1°	M52× 0.75	<1.5%	5	Standard
LEM1616CE-H1	16	F1.6	1.0m ~ ∞	54.3°× 44.2°× 33.5°	M37× 0.5	<1.0%	5	Standard
LEM2220CE-H1	22	F2.0	0.4m ~ ∞	40°× 32°× 24°	-	<1.0%	5	Standard
LEM2516CE-H1	25	F1.6	1.0m ~ ∞	36.2°× 29.0°× 21.8°	M39× 0.5	<1.0%	5	Standard
LEM3514CE-H1	35	F1.4	1.0m ~ ∞	25.7°× 20.7°× 15.6°	M39× 0.5	<1.0%	5	Standard
LEM0618CBMP9-H1	6	F1.8	0.1m ~ ∞	107.5°× 95.4°× 78.4°	-	<2.3%	9	Standard
LEM0814CBMP9-H1	8	F1.4	0.1m ~ ∞	89.5°× 77.1°× 61.8°	-	<5%	9	Standard
LEM1214CBMP9-H1	12	F1.4	0.1m ~ ∞	64.44°× 53.6°× 41.8°	M40.5× 0.5	<0.5%	9	Standard
LEM1614CBMP9-H1	16	F1.4	0.1m ~ ∞	50.0°× 41.76°× 33.68°	M40.5× 0.5	<0.3%	9	Standard
LEM2514CBMP9-H1	25	F1.4	0.1m ~ ∞	34.94°× 28.7°× 22.06°	M40.5× 0.5	<0.1%	9	Standard
LEM3514CBMP9-H1	35	F1.4	0.15m ~ ∞	23.92°× 19.28°× 14.32°	M40.5× 0.5	<0.1%	9	Standard
LEM5016CBMP9-H1	50	F1.6	0.3m ~ ∞	18.0°× 14.6°× 11.7°	M40.5× 0.5	<0.1%	9	Standard
LEM7518CBMP9-H1	75	F1.8	0.8m ~ ∞	12.2°× 9.8°× 7.4°	M52× 0.75	<0.05%	9	Standard

4/3" C-MOUNT FIXED LENSES

Part name	Focal Length (mm)	Aperture (F/#)	Range of WD (m)	Angle of View (deg.)	Filter Size	Mega pixels	Weight (g)	Type
LEM08528CD-H2	8.5	2.8	0.5m ~ ∞	107.38°× 94.89°× 77.93°	M77× 0.5	12		Standard
LEM1220CD-H2	12	2.0	0.15m ~ ∞	89.02°× 75.46°× 61.08°	M77× 0.75	10	447	Standard
LEM1620CD-H2	16	2.0	0.1m ~ ∞	72.92°× 60.92°× 47.28°	-	10	338	Standard
LEM2520CD-H2	25	2.0	0.15m ~ ∞	49.7°× 40.6°× 31°	M46× 0.75	10	251	Standard
LEM3520CD-H2	35	2.0	0.2m ~ ∞	36.6°× 29.6°× 22.4°	M40.5× 0.5	10	173	Standard
LEM5020CD-H2	50	2.0	0.3m ~ ∞	25.9°× 20.9°× 15.7°	M40.5× 0.5	10	170	Standard

1.1" C-Mount Fixed Lenses

HOT

1. Momo-focal for best image quality
2. High performance for 10 mega pixels camera
3. Large aperture ratio for low illumination
4. TV Free distortion less than 1%
5. Focus range from 0.1M to Infinity
6. Higher relative illuminate rate at corner



LEM0618CBMP9-H1

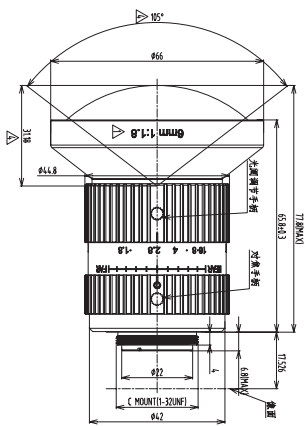

Image Size (inch)	1.1"
Focal Length (mm)	6.0
Aperture, F/#	1.8~Close
M.O.D.	0.1m
FOV(°)	118.2°x104.9°x86.2°
Distortion(TV)	<2.5%
Flange back	17.526mm in air
Back focus	13.57mm in air
Filter screw size	-
Front/Rear Effective Dia.	Front Ø58.6mm Rear Ø15.05mm
Mount	C-Mount
Temperature Range	-10~+50°C
Storage Temperature Range	-20~+60°C

LEM0814CBMP9-H1

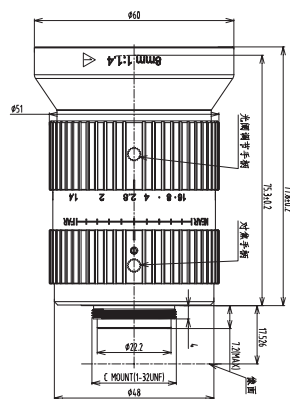

Image Size (inch)	1.1"
Focal Length (mm)	8.0
Aperture, F/#	1.4~Close
M.O.D.	0.1m
FOV(°)	98.4°x84.8°x68°
Distortion(TV)	<5.5%
Flange back	17.526mm in air
Back focus	10.35mm in air
Filter screw size	-
Front/Rear Effective Dia.	Front Ø40.52mm Rear Ø17.32mm
Mount	C-Mount
Temperature Range	-10~+50°C
Storage Temperature Range	-20~+60°C

LEM1214CBMP9-H1

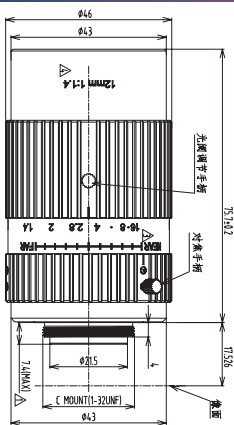

Image Size (inch)	1.1"
Focal Length (mm)	12.0
Aperture, F/#	1.4~Close
M.O.D.	0.1m
FOV(°)	70.9°x59°x46°
Distortion(TV)	0.55%
Flange back	17.526mm in air
Back focus	12.497mm in air
Filter screw size	M40.5x0.5
Front/Rear Effective Dia.	Front Ø32.4mm Rear Ø15.34mm
Mount	C-Mount
Temperature Range	-10~+50°C
Storage Temperature Range	-20~+60°C

LEM1614CBMP9-H1

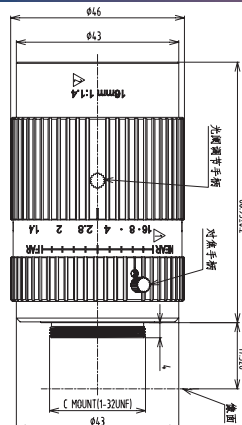

Image Size (inch)	1.1"
Focal Length (mm)	16.0
Aperture, F/#	1.4~Close
M.O.D.	0.1m
FOV(°)	55°x45.9°x37°
Distortion(TV)	0.33%
Flange back	17.526mm in air
Back focus	19.45mm in air
Filter screw size	M40.5x0.5
Front/Rear Effective Dia.	Front Ø34.4mm Rear Ø15.1mm
Mount	C-Mount
Temperature Range	-10~+50°C
Storage Temperature Range	-20~+60°C

LEM2514CBMP9-H1

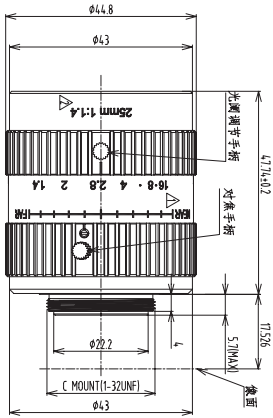

Image Size (inch)	1.1"
Focal Length (mm)	25.0
Aperture, F/#	1.4~Close
M.O.D.	0.1m
FOV(°)	38.4°×31.6°×24.9°
Distortion(TV)	0.1%
Flange back	17.526mm in air
Back focus	12.46mm in air
Filter screw size	M40.5×0.5
Front/Rear Effective Dia.	Front Ø19.8mm Rear Ø13.7mm
Mount	C-Mount
Temperature Range	-10~+50°C
Storage Temperature Range	-20~+60°C

LEM3514CBMP9-H1

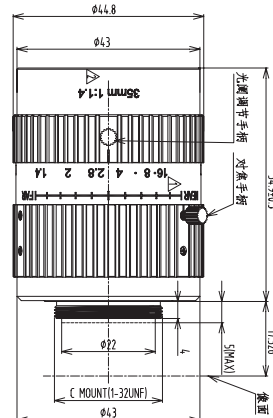

Image Size (inch)	1.1"
Focal Length (mm)	35.0
Aperture, F/#	1.4~Close
M.O.D.	0.15m
FOV(°)	26.3°×21.2°×15.7°
Distortion(TV)	0.1%
Flange back	17.526mm in air
Back focus	15.3mm in air
Filter screw size	M40.5×0.5
Front/Rear Effective Dia.	Front Ø23.4mm Rear Ø17.2mm
Mount	C-Mount
Temperature Range	-10~+50°C
Storage Temperature Range	-20~+60°C

LEM5016CBMP9-H1

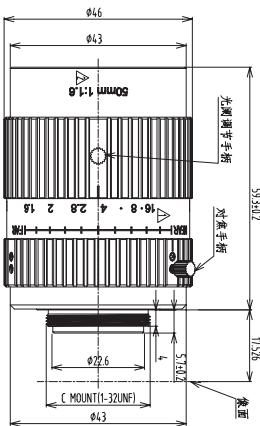

Image Size (inch)	1.1"
Focal Length (mm)	50.0
Aperture, F/#	1.6~Close
M.O.D.	0.3m
FOV(°)	19.8°×16.1°×12.9°
Distortion(TV)	0.1%
Flange back	17.526mm in air
Back focus	11.85mm in air
Filter screw size	M40.5×0.5
Front/Rear Effective Dia.	Front Ø30mm Rear Ø16mm
Mount	C-Mount
Temperature Range	-10~+50°C
Storage Temperature Range	-20~+60°C

LEM7518CBMP9-H1

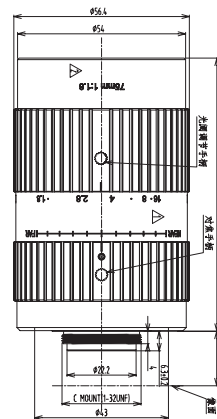

Image Size (inch)	1.1"
Focal Length (mm)	75.0
Aperture, F/#	1.8~Close
M.O.D.	0.8m
FOV(°)	13.4°×10.8°×8.1°
Distortion(TV)	0.05%
Flange back	17.526mm in air
Back focus	13.57mm in air
Filter screw size	M52×0.75
Front/Rear Effective Dia.	Front Ø39.4mm Rear Ø18mm
Mount	C-Mount
Temperature Range	-10~+50°C
Storage Temperature Range	-20~+60°C